

RADIO CRAFT

DUAL FM-AM
TRANSMITTER
SEE PAGE 27

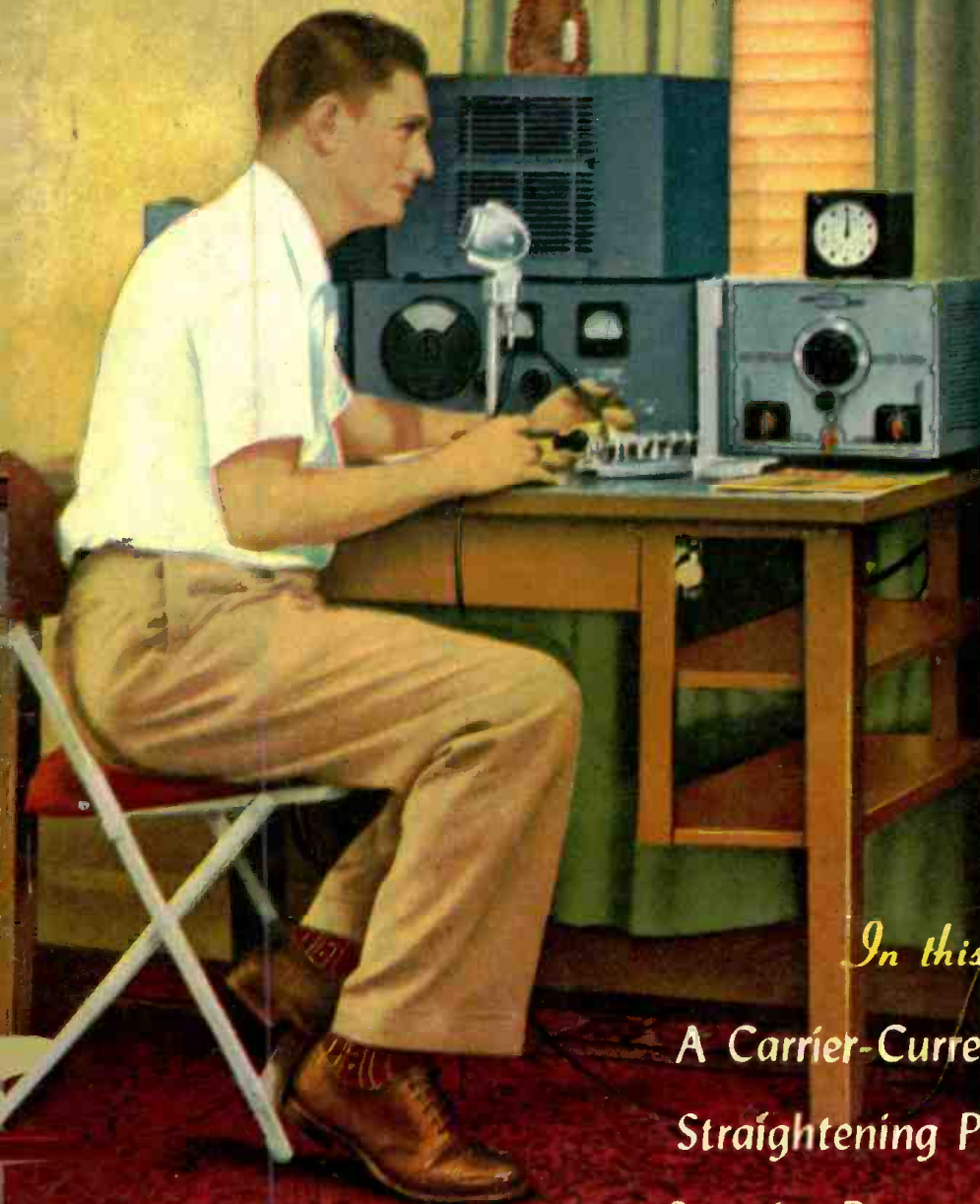

In this issue—

A Carrier-Current Transmitter
Straightening Plastic Cabinets
Superior Rotary Antenna Array

OCT
1947

25¢

CANADA 30¢

RADIO-ELECTRONICS IN ALL ITS PHASES

**HERE ARE SIMPSON'S
PROFIT-MAKERS FOR
SERVICEMEN...**

"BASIC 3"

The serviceman who tries to "get along" with cheaply-made, run-of-the-mill test instruments is taking an outside chance on success. The business of radio servicing must be *built* from the bottom up on an endless succession of perfect jobs. Knowing what the trouble is, in a receiver, and knowing when that trouble is eliminated *can be no better than the test instruments that reveal them.*

The "Basic 3" Simpson instruments shown here are an extremely profitable investment for any serviceman. He needs all three and, in their price range, he cannot buy better anywhere else. In fact, in their price range they are unequalled. They will do more than many instruments selling for substantially more. These are facts easily demonstrable to any serviceman who will take the time to check up. And it is worth the time in the *cold cash of profits* to discover how Simpson engineering skill and uncompromising quality construction produce the *staying* accuracy for which Simpson instruments are famous.

MODEL 315 SIGNAL GENERATOR. Designed down to the most minute detail for highest accuracy, greatest stability, minimum leakage, and good wave form **\$67.35**

MODEL 305 RC TUBE TESTER. Tests all tubes. Provides for filament voltages from .5 volts to and including 120 volts. Spare sockets for future tube developments **\$59.50**

MODEL 260 HIGH SENSITIVITY SET TESTER. 20,000 ohms per volt, D.C. Voltage ranges to 5,000 volts A.C. and D.C. Resistance ranges to 20 megohms. Current ranges to 500 milliamperes, also 10 amperes D.C. **\$38.95**

In New Roll Top Safety Case **\$43.75**

SIMPSON ELECTRIC COMPANY • 5200-5218 West Kinzie Street, Chicago 44

In Canada, Bach-Simpson, Ltd., London, Ont.

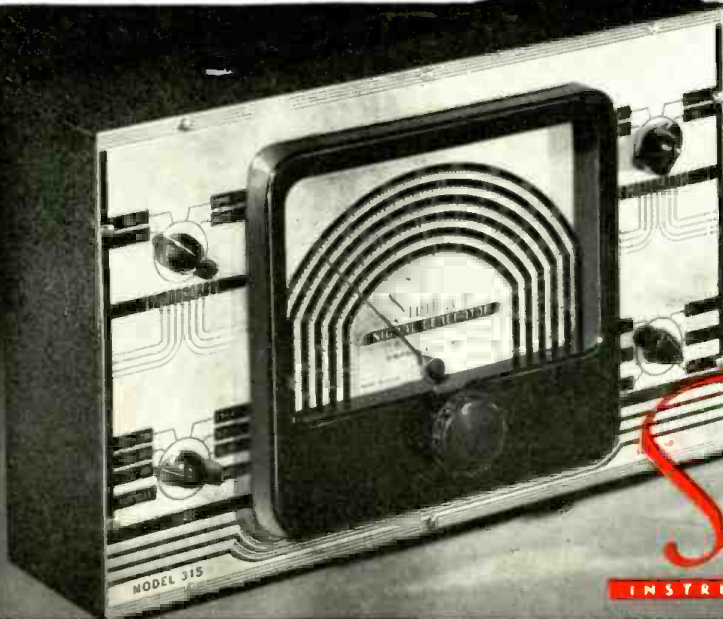

Simpson
INSTRUMENTS THAT STAY ACCURATE



Building this
A. M. SIGNAL GENERATOR
gives you valuable experience. Provides amplitude modulated signals for test and experiment purposes.

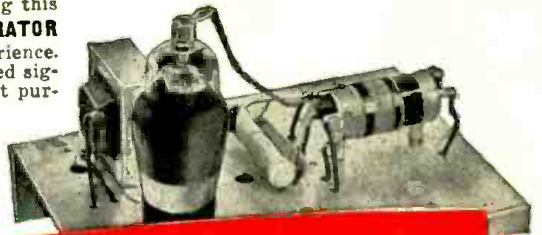

RADIO SERVICING

pays good money for full time work. Many others made \$5, \$10 a week EXTRA fixing Radios in spare time.

VETERANS

You can get this training right in your own home under G. I. Bill. Mail coupon for full details.

Learn RADIO by PRACTICING in Spare Time

with Big Kits of Radio Parts I Send You

Do you want a good-pay job in Radio—or your own money-making Radio Shop? Mail Coupon for a FREE Sample Lesson and my FREE 64-page book, "How to Be a Success in RADIO—Television, Electronics." See how N.R.I. gives you practical Radio experience at home—building, testing, repairing Radios with BIG KITS OF PARTS I send!

Many Beginners Soon Make Good Extra Money In Spare Time While Learning

The day you enroll I start sending EXTRA MONEY manuals. You LEARN Radio principles from my easy-to-grasp, illustrated lessons—PRACTICE what you learn with parts I send—USE your knowledge to make EXTRA money fixing neighbors' Radios in spare time while still learning! From here it's a short step to your own full-time Radio Shop or a good Radio Job!

Future for Trained Men is Bright in Radio, Television, Electronics

It's probably easier to get started in Radio now than ever before because the Radio Repair business is booming. Trained Radio Technicians also find profitable opportunities in Police, Aviation, Marine Radio, Broadcasting, Radio Manufacturing, Public Address work. Think of even greater opportunities as Television and Electronics become available to the public! Send for free books now!

Find Out What N. R. I. Can Do For You

Mail Coupon for Sample Lesson and my 64-page book. Read the details about my Course. Read letters from men I trained, telling what they are doing, earning. See how quickly, easily you can get started. No obligation! Just MAIL COUPON NOW in an envelope or paste it on a penny postal. J. E. Smith, President, Dept. 7KX, National Radio Institute, Pioneer Home Study Radio School, Washington 9, D. C.

My Course Includes Training in
TELEVISION ★ ELECTRONICS
Frequency Modulation



You build this SUPERHETERODYNE CIRCUIT that brings in local and distant stations. You get practical experience putting this set through fascinating tests.

You build this MEASURING INSTRUMENT yourself early in the course—use it for practical Radio work on neighborhood Radios to pick up EXTRA spare time money!

BE A SUCCESS in RADIO I Will Train You at Home

Sample Lesson FREE



Gives hints on Receiver Servicing, Locating Defects, Repair of Loudspeaker, I. F. Transformer, Gang Tuner, Condenser, etc., 31 illustrations. Study it—keep it—use it—without obligation! Mail Coupon NOW for your copy!



GET BOTH 64 PAGE BOOK SAMPLE LESSON FREE

Mr. J. E. SMITH, President, Dept. 7KX National Radio Institute, Washington 9, D. C.

Mail me FREE, without obligation, Sample Lesson and 64-page book about how to win success in Radio and Television-Electronics. (No salesman will call. Please write plainly.)

Name
Address
City Zone State

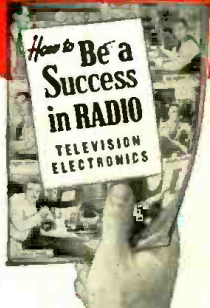

APPROVED FOR TRAINING UNDER GI BILL

SYLVANIA NEWS

RADIO SERVICE EDITION

OCT.

Prepared by SYLVANIA ELECTRIC PRODUCTS INC., Emporium, Pa.

1947

RADIO SERVICEMEN! MAKE YOUR SERVICE JOB EASIER WITH THESE TECHNICAL SHOP AIDS

Sylvania Receiving Tube Manual and Other Guides Save You Time and Increase Your Efficiency

220 TECHNICAL SECTION BINDER
Containing all back issues of Technical Sections from May, 1935, Vol. 1 (May 1935 to Jan. 1941) \$1.00. Vol. 2 (Jan. 1941 to date) \$1.00.

202 TECHNICAL MANUAL
Complete data on Sylvania Receiving Tubes85¢

221 CHARACTERISTICS SHEET
Characteristics of Sylvania tubes and panel lamps with tube base views. Free.

353 RADIO SYMBOL GUIDE
Made of durable plastic. Adds neatness to your schematics. 25¢ each.

238 COLOR CODE CHART
Resistor Values and Ohm's Law. Free.

351 "LOCK-IN" TUBE PULLER, 35¢ each.

HELPFUL "HINTS" BOOKLETS
For Radio Servicing. Free!
208 Service Hints
226 Radio Tube Hints
227 Radio Circuit Hints
228 Radio Equipment Hints

Once again Sylvania brings you a carefully selected group of technical aids which we honestly believe will help make your job easier.

These expertly compiled technical manuals, service guides and shop aids are based on Sylvania's many successful years of experience in the radio field.

They will improve the speed and efficiency of your service work and help make your job easier in every way!

So—why not get the *most* out of your store?

First, handle a full line of Sylvania tubes—the finest line of radio tubes made. Second, invest the few cents necessary to obtain this splendid group of technical aids—and see how they will repay you in time-saving efficiency.

Order from your Sylvania Distributor or write Sylvania Electric Products Inc., Emporium, Pa.

SYLVANIA ELECTRIC

MAKERS OF RADIO TUBES; CATHODE RAY TUBES; ELECTRONIC DEVICES; FLUORESCENT LAMPS, FIXTURES, WIRING DEVICES; ELECTRIC LIGHT BULBS

Don't Miss PHOTOFAC Set No. 23!

WITH EXCLUSIVE NEW "Standard Notation" SCHEMATICS

The Greatest Service Data Development in 20 Years!

I am proud to announce to my Servicemen friends the successful development of a new system of "Standardized Schematics" that is now yours exclusively in PHOTOFAC Folders. We have worked on this project for over one year, because we knew that uniform, standardized schematics would save you hours of time and countless headaches—would help you earn more. NOW—we have developed uniform, standardized diagrams on all sets. Now—you can save time—go from diagram to diagram and see the same, easy-to-understand symbols and designations. You no longer have to puzzle out the differences in schematic notations or bang your head against queer-looking diagrams. You'll recognize instantly the functions of all parts in any circuit. The standards used in our new diagrams are yours—the result of the PHOTOFAC "Standards Poll" and thousands of interviews with Servicemen. I wish space would permit me to tell you more—but PHOTOFAC Set No. 23 speaks for itself. You owe it to yourself to see the new diagrams. Use them—learn what a difference they'll make in faster, more profitable servicing.

Howard W. Sams

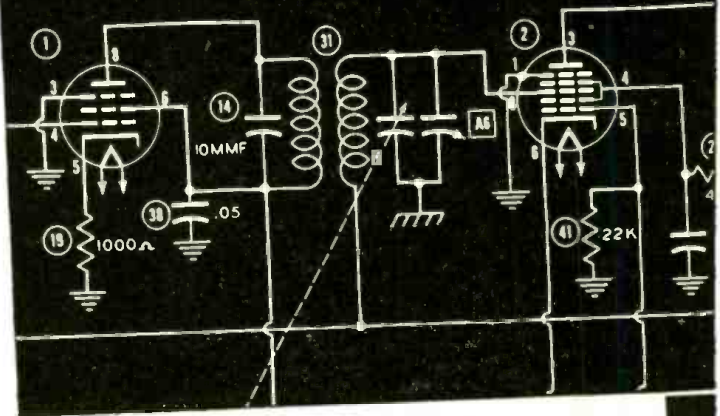

NOW! UNIFORM SCHEMATICS FOR FASTER, MORE PROFITABLE WORK!

Beginning with Set No. 23, and thereafter, all PHOTO-FACT Folders will feature the new, uniform "Standard Notation" schematics. Each and every diagram is drawn to the same basic set of clear, uniform, easy-to-understand standards. Here's what the new "Standard Notation" Schematics mean to you: Makes circuit analysis simple, quicker, fool-proof, more accurate! No more time wasted puzzling over odd-looking diagrams! No more trouble with varying symbols and confusing styles! Just ONE CLEAR STANDARDIZED STYLE FOR ALL CIRCUITS—SAVES YOU TIME—HELPS YOU EARN MORE. Only PHOTOFAC offers you the "Standard Notation" Schematics!

TWO IMPORTANT NEW HOWARD W. SAMS PUBLICATIONS

DIAL CORD STRINGING GUIDE

There's only one *right* way to string a dial cord. And there's only one book that shows you how. It's the Howard W. Sams DIAL CORD STRINGING GUIDE. Here, for the first time, in one handy pocket-sized book, are all available dial cord diagrams and data covering 1938 through 1946 receivers. Licks the knottiest dial cord problem in a matter of minutes. This low-cost book is a "must" for servicing. You'll want two copies—one for your tool kit and one for your shop bench. Order them today.

ONLY **75c**

1947 AUTOMATIC RECORD CHANGER MANUAL

Nothing like it! COVERS MORE THAN 40 DIFFERENT POST-WAR MODELS. Absolutely accurate, complete, authoritative—based on actual study of the equipment. Shows exclusive "exploded" views, photos from all angles. Gives full change cycle data, information on adjustments, service hints and kinks, complete parts lists. Shows you how to overcome any kind of changer trouble. PLUS—for the first time—complete, accurate data on leading WIRE, RIBBON, TAPE, and PAPER DISC RECORDERS! Over 400 pages; hard cover; opens flat. No modern service shop can afford to be without this manual. \$4.95 ONLY.

ONLY **\$4.95**

HOWARD W. SAMS & CO., INC.
INDIANAPOLIS 6, INDIANA

Export—Ad. Auriema—89 Broad St., New York 4, N. Y.—U. S. of America
Canada—A. C. Simmonds & Sons, 301 King St., East—Toronto, Ontario

PHOTOFAC SERVICE

"The Service that pays for itself over and over again"

FREE PHOTOFAC AIDS!

FREE. PHOTOFAC CUMULATIVE INDEX
—Your guide to more than 1800 receiver models and chassis (1946 and 1947 models covered in PHOTOFAC Folder Sets 1 through 20).

FREE. HOW TO FILE FOLDER—Shows 5 good ways to file PHOTOFAC Folders, including new "30-Second" filing method.

Ask your parts jobber for FREE copies of these PHOTOFAC aids, or write us direct.

RESERVE SET NO. 23 TODAY

MAIL THIS ORDER FORM TO YOUR PARTS JOBBER TODAY—or send directly to HOWARD W. SAMS & CO., INC., 2924 E. Washington Street, Indianapolis 6, Indiana.

My (check) (money order) for \$..... enclosed.

- Send PHOTOFAC Set No. 23 (at \$1.50).
- Send . . . SAMS' DIAL CORD STRINGING GUIDE(S), at \$0.75 per copy.
- Send . . . SAMS' 1947 AUTOMATIC RECORD CHANGER MANUAL(S) at \$4.95 per copy.
- Send PHOTOFAC Volume No. 1 (including Sets Nos. 1 through 10) with DeLux Binder. \$18.39.
- Send PHOTOFAC Volume No. 2 (including Sets Nos. 11 through 20) in DeLux Binder. \$18.39.
- Send FREE PHOTOFAC Aids.

Name

Address

City State

Distinctive beauty

SUPERB PERFORMANCE



TURNER COLORTONE DYNAMIC—MODEL 5D

● The post-war microphone sensation. Beauty that sings to the eye and ear. Turner Colortones bring sparkling color to stage and orchestra settings, home recorders, television studios, night spots, etc. Their high quality reproduction accents the performance of finest recording and sound system equipment. Cases are styled in a choice of gleaming ivory, rich orange, bright yellow, and soft pastel green finishes. Improved dynamic circuit with Turner precision diaphragm and Alnico V magnets provides extremely accurate pickup and smooth wide-range response to voice and music. Shielded output transformer excludes all annoying hum pickup. Available in four standard impedances with or without built-in slide switch. See them today at your dealer.

SPECIFICATIONS

MODEL 5D COLORTONE DYNAMIC

EFFECTIVE OUTPUT LEVEL: 52 db below 1 volt/dyne/sq. c. m. at high impedance.

FREQUENCY RESPONSE: Flat within ± 5 db from 50-9000 c. p. s.

OUTPUT IMPEDANCE: 50, 200, 500, ohms, high.

DIRECTIONAL CHARACTERISTICS: Semi-directional. Non-directional when tilted back 90°.

DIAPHRAGM: Highest quality, corrosive resistant aluminum.

MAGNETIC CIRCUIT: Employs highest quality Alnico V magnet. Highly shielded output transformer excludes all hum pickup.

CASE: Tenite. With 90° tilting head. Rubber tilt brake holds in any position.

FINISH: Choice of yellow, green, ivory, orange.

MOUNTING: $\frac{5}{8}$ "—27 standard coupler.

CABLE: 20 ft. removable, shielded, single conductor, with connector.

DIMENSIONS: $4\frac{1}{4}$ " long x $2\frac{1}{2}$ " wide x $4\frac{1}{2}$ " high.

WEIGHT: 17 ounces.

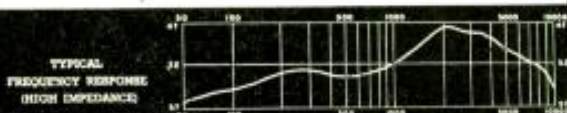

ALSO AVAILABLE WITH HIGH QUALITY CRYSTAL CIRCUIT AS MODEL 5X

MICROPHONES IN COLOR

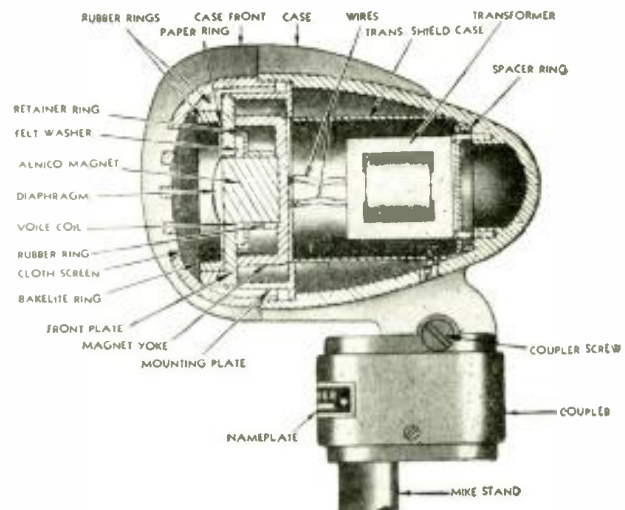

INTERIOR CONSTRUCTION MODEL 5D

Turner Colortone Dynamics will stop you with their beauty—you'll choose one for its superior quality.

THE TURNER COMPANY
902 17th Street N. E.
Cedar Rapids, Iowa



I'll Send You 8 Big Kits of Training Equipment
including

TWO-BAND 6 TUBE SUPER RECEIVER
AND 16 RANGE METER SET-UP
for Testing

Learn Fast... Earn Fast
HOME TRAINING
Planned For Your Needs
You Build All These
TESTERS... and MORE!

I give you a fine, moving-coil type Meter Instrument on Jewel Bearings—with parts for a complete Analyzer Circuit Continuity Tester. You learn how to check and correct Receiver defects with professional speed and accuracy.



Practice Does It!

Soldering, wiring, connecting Radio Parts... building circuits with your own hands—you can't beat this method of learning. When you construct this Rectifier and Filter Resistor and Condenser Tester, etc., you get a really practical slant on Radio that leads to a money-making future.

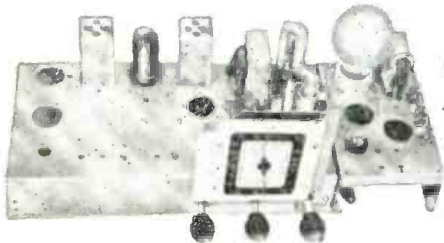
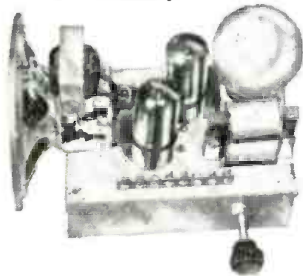

Building this Signal Generator and multi-purpose Tester will give you the kind of valuable experience and practice that is so important as a foundation for making good money in Radio. It makes a breeze out of fixing Radios, and you don't have to spend money on ready-made Equipment.

VETERANS

YOU CAN GET SPRAYBERRY TRAINING AT HOME UNDER G.I. BILL. MAIL COUPON FOR FULL DETAILS.

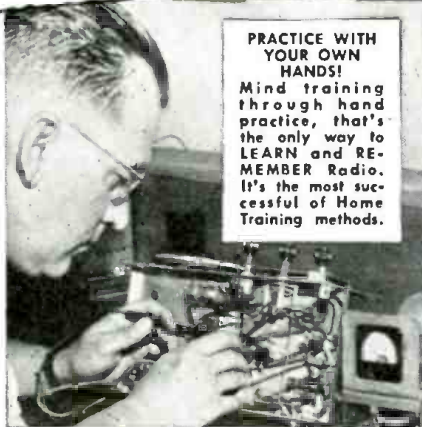

PRACTICE WITH YOUR OWN HANDS!
Mind training through hand practice, that's the only way to LEARN and REMEMBER Radio. It's the most successful of Home Training methods.



OVER 175 PRACTICAL EXPERIMENTS
You'll find out how to build countless Radio Circuits. You'll learn a new, fast way to test Radio Sets without mfg. Equipment.

LOW COST HOME RADIO TRAINING!
Easy Monthly Payments!

The answer to the PRACTICAL results, I show my Students lies in the way I train you. Not books and lessons alone. But "sight demonstrations" with real Radio Parts worked out with your own hands. You LEARN! You UNDERSTAND! You REMEMBER! Pay special attention to the quality and completeness of the Equipment which comes with the Sprayberry Course. You get a big 6 Tube Super Receiver and a 16 Range Meter Set-up for testing. When I put you to work with the 8 big Kits of Radio Parts I send you, you'll really LEARN Radio and learn it RIGHT! You'll get the practical experience

and pre-conditioning you need to be useful in Radio, and that's what it takes to make money. You don't need any previous experience. The Sprayberry Course starts right at the beginning of Radio—you can't get lost! Soon after you begin your Sprayberry Course, I'll send you my sensational BUSINESS BUILDERS. You'll learn how to get and do neighborhood Radio repair jobs for nice profits and rich experience. With the kind of Training I give you, you will be able to set up your own Business, or step into a good-pay job in Radio, Television, FM, Radar, Industrial Electronics. Don't waste time! Make your start NOW!

MAIL COUPON FOR THESE 2 BOOKS!



"How to Read Radio Diagrams and Symbols" and "How to Make Money in Radio, Electronics and Television." Immense, practical value to you—and they're yours FREE!

SPRAYBERRY ACADEMY OF RADIO
F. L. Sprayberry, President
Room 20107, Pueblo, Colorado

Please rush my FREE copies of "How to MAKE MONEY in RADIO, ELECTRONICS and TELEVISION" and "How to READ RADIO DIAGRAMS and SYMBOLS."

Name _____ Age _____

Address _____

City _____ State _____

(Mail in envelope or paste on penny postcard)



This New IRC JUNIOR Control Cabinet Belongs on Your Bench

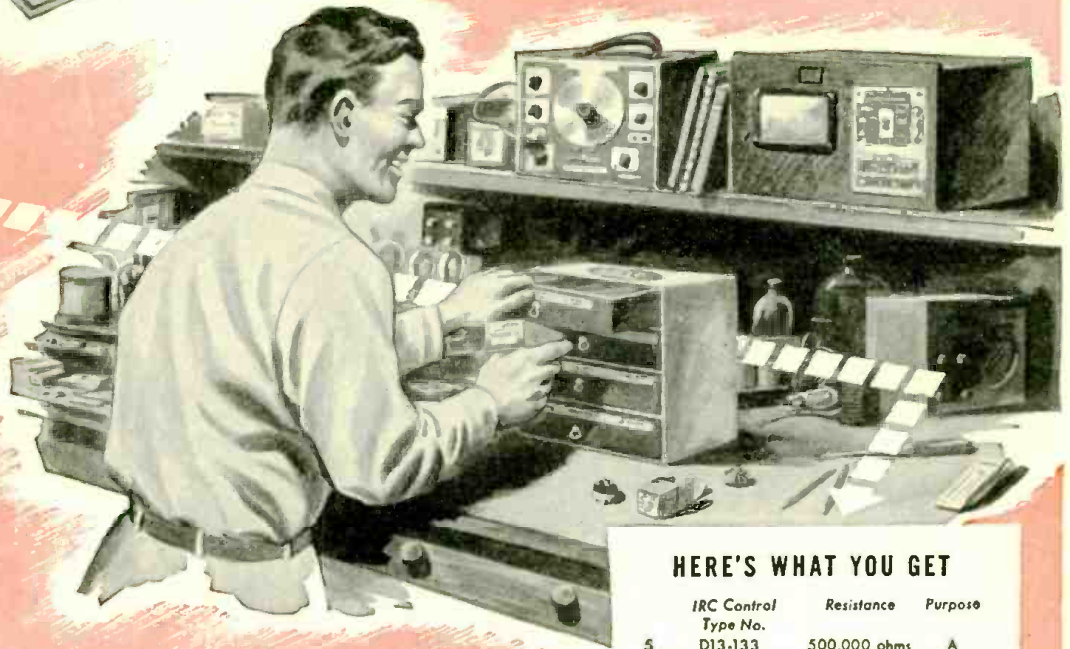

Here's one selection of 9 "hot-number" controls, switches and shafts you'll use every day! The new IRC Junior Control Cabinet contains 9 of the most-used 1/2, 1 and 2 meg. type D controls with the added adaptability of the tap-in shaft feature—plus 4 switches and 4 special shafts.

This inexpensive assortment of popular controls will save you time and money, and reduce your need for exact replacements. Factory-packed in a handsome four drawer cabinet of sturdy cardboard. Cabinet attractively finished in blue, yellow and silver with twelve individually identified compartments. Order the new inexpensive JUNIOR Control Cabinet from your IRC Distributor today. International Resistance Company, 401 N. Broad Street, Philadelphia 8, Pennsylvania. In Canada: International Resistance Company, Ltd., Toronto, Licensee.

HERE'S WHAT YOU GET

	IRC Control Type No.	Resistance	Purpose
5	D13-133	500,000 ohms	A
1	D13-133X	500,000 ohms	B
1	D13-137	1.0 meg.	A
1	D13-137X	1.0 meg.	B
1	D13-139	2.0 meg.	A

Purpose: A-Tone or Audio Circuit control;
B-Tapped for tone compensation.

SWITCHES

3	#41	S.P.S.T.
1	#42	D.P.S.T.

SHAFTS

1 Type "A" double-flatted tap-in shaft is included with each control—plus:

3 Type "E" with universal knurl for special type push on knobs.

1 Type "H" with universal groove for many Delco, RCA, Sears-Roebuck and Westinghouse models.

INTERNATIONAL RESISTANCE COMPANY
 Wherever the Circuit says 



Now IN YOUR OWN HOME Learn

RADIO ELECTRONICS

The Practical
"HOME-TESTED"
Modern "A-B-C" Way



YOU USE ALL OF THESE RADIO PARTS
TO BUILD AND OPERATE
7
DIFFERENT RADIO RECEIVING CIRCUITS

NO PREVIOUS RADIO OR ELECTRICAL EXPERIENCE NECESSARY

DeForest's Training, Inc. provides every major home study aid to help you learn Radio-Electronics rapidly and thoroughly . . . to give you the experience and confidence needed for a responsible, Good-Pay Job, or to Start a Business of Your Own! Here is a REAL opportunity field for YOU . . . when you are a trained Radio-Electronics man! Just think of the tremendously exciting future ahead of FM Radio, Aviation and Broadcast Radio, Sound Motion Picture Equipment, Servicing and Sales of Radio Equipment, etc. Put yourself in this picture . . . See how you can benefit from a PRACTICAL training in this fascinating work! Think, too, of the coming possibilities ahead of Radar, Facsimile and Television. Send TODAY for the interesting, opportunity-revealing book, "Victory for You!" See how others probably no more talented or ambitious than you, have advanced in earning power after this training . . . how YOU can do it too! Mail the coupon NOW!

INCLUDING:

1. Simple Receiver
2. Two Tube Receiver
3. Tuned Radio-Frequency Receiver
4. Short Wave Receiver
5. Aviation Band Receiver
6. 4-Tube Superheterodyne
7. 5-Tube Superheterodyne with Magic Tuning Eye

... PLUS SCORES OF OTHER FASCINATING, INSTRUCTIVE RADIO-ELECTRONIC EXPERIMENTS

WITH THE HELP OF

A EIGHT Big Kits of Actual "Learn-by-Doing" Radio Parts and Assemblies with which you make 133 fascinating SHOP METHOD EXPERIMENTS in your own home! Imagine building 7 different Radio Receivers that operate!

B A 16 mm Home Movie Projector and Twelve Reels of "Learn-by-Seeing" Home Movie Films . . . for picture-clear, fast understanding of Radio Fundamentals!

C Modern, well-illustrated, Loose-leaf Lessons, prepared in clear, simple, understandable language . . . to guide you throughout your training!

THEN GET THE HELP OF OUR EFFECTIVE EMPLOYMENT SERVICE

16 MM MOVIE PROJECTOR
YOU USE "LEARN-BY-SEEING" MOVIES

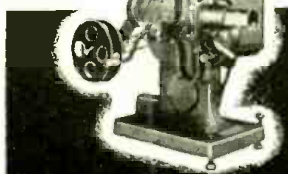

DEFOREST'S TRAINING, INC. INCLUDES INSTRUCTION IN MOTION PICTURE SOUND EQUIPMENT, FM RADIO AND TELEVISION . . . RESIDENTIAL TRAINING IN OUR MODERN CHICAGO LABORATORIES ALSO AVAILABLE—ASK US FOR INFORMATION!

VETERANS!

Big things are happening at DeForest's Training, Inc. for veterans! See how you can prepare yourself WITHOUT COST for a GOOD JOB or a BUSINESS OF YOUR OWN in the vast Radio-Electronic opportunity field.



E. B. DEVRY, President
DEFOREST'S TRAINING, INC.
2535-41 North Ashland Ave., Dept. RC-D10
Chicago 14, Illinois, U.S.A.

Send FREE "VICTORY FOR YOU!" BOOK, showing how I may make my start in Radio Electronics.

Name _____ Age _____

Address _____ Apt. _____

City _____ Zone _____ State _____

If under 16, check here for special information.

If a discharged Veteran of World War II, check here.

DeFOREST'S TRAINING, INC.
CHICAGO 14, ILLINOIS



5 WORDS that assure **ACCURACY, DEPENDABILITY** and **VALUE**
in all **SILVER** test instruments

You . . . and every serious service technician . . . have long dreamed of your shop equipped with the same caliber of laboratory instruments found in the factories making the radios you must service. Today's complex AM, FM and Television receivers can't be efficiently serviced by anything less.

Under war pressure McMurdo Silver devised new techniques to lift the manufacture of laboratory-type instruments out of the costly model-shop. He discovered how to put them on the low-cost, high-volume production line. The result is instruments of laboratory precision, accuracy, dependability . . . at prices far below what you'd expect to pay. These are the same identical **Laboratory Caliber Electronic Test Instruments** the big manufacturers, universities and the government select.

Can you afford less than the best — when the best costs you less?

MODEL 906 FM/AM SIGNAL GENERATOR: 8 ranges calibrated $\pm 1\%$ accurate, 90 kc. thru 210 mc. 0-100% variable 400 μ AM; 0-500 kc. variable FM sweep built-in. Metered micravolts; variable 0-1 volt. Strays lower than \$500 laboratory generators. Only \$99.50 net.

"VOMAX" UNIVERSAL V.T.V.M.: The overwhelming choice of experts. 51 ranges, d.c., a.c., a.f., i.f., r.f., current, db., and resistance. Visual signal tracing to 500 mc. New 5" pencil-thin flexible r.f. probe. Only \$59.85 net.

MODEL 904 CONDENSER/RESISTANCE TESTER: Measures accurately $\frac{1}{4}$ mmfd. thru 1,000 mfd.; $\frac{1}{4}$ thru 1,000 meg Ω . Internal 0-500 V. variable d.c. polarizing voltage. Measures condensers with rated d.c. volts applied. Only \$49.90 net.

MODEL 905 "SPARX" SIGNAL TRACER: Visual and audible tracing; also tests phono pickups, microphones, speakers, PA amplifiers. Is your shop test-speaker, too. 20 μ thru 200 mc.; PM speaker; mains-insulated transformer power supply. Only \$39.90 net.

OVER 36 YEARS OF RADIO ENGINEERING ACHIEVEMENT

McMurdo Silver Co., Inc.

1249 MAIN ST., HARTFORD 3, CONNECTICUT

SEND FOR COMPLETE CATALOG. See these and Silver communication transmitters, receivers, "Micro-match", Xtal-controlled VFO, pre-tuned freq. multiplier at your jobber.

Opportunity now FOR YOU!

NATIONAL SCHOOLS SHOP METHOD

HOME TRAINING in RADIO TELEVISION and ELECTRONICS

A PRACTICAL RESIDENT TRADE SCHOOL

With Its Own Shops and Laboratories FOR OVER 40 YEARS

TODAY, OPPORTUNITIES IN THE RADIO, ELECTRONICS AND TELEVISION INDUSTRY ARE TAKEN FOR GRANTED

We see them everywhere: The Home Radio Service Field continues to grow. Television is here . . . Television Broadcasting facilities are being rapidly expanded. Television sales, service, installation and maintenance requirements are more and more important from day to day. Electronics is an important factor in many applications for utility, safety, accuracy and convenience. Airlines are finding new uses for Radio bringing new benefits to air transportation. Ships at sea are employing Radar together with other conventional Radio apparatus for ship-to-shore communications and safety. Frequency Modulation is modernizing Radio Broadcasting, offering static-and-interference-free reception in the home. The list of Radio applications is almost endless, and every one represents increasing opportunities in our modern world for the **RADIO, TELEVISION AND ELECTRONICS TECHNICIAN WITH A SOLID TECHNICAL BACKGROUND.**

NOT JUST ANY TRAINING WILL DO

It is not a question of opportunity but rather how to take advantage of existing opportunity. Only proper training can make these opportunities a reality. National Schools of Los Angeles, one of the oldest and largest technical trade schools in the United States, offers you Shop Method Home Training, a proved method that builds qualified technicians. Here is Home Training that **BRINGS RESULTS.**

Behind all training from National Schools stands a permanent faculty of experienced instructors and engineers. These men are daily teaching resident students right in our own Shops and Laboratories. From first hand experience with students here at school, our instructors understand the needs and ambitions of men like you. All of our instructors, both Home Study and Resident, have ideal facilities to make your training practical, up-to-the-minute, interesting. It takes years of experience to know how to train men, especially in the practical technical trades. Established almost 50 years ago, National Schools has a rich background of experience to help you to take full advantage of the opportunities in the Radio, Television and Electronics Industry.

HERE'S JUST A FEW OF THE INTERESTING FACTS YOU LEARN WITH THE FREE MANUAL

1. Routine for Diagnosing Radio Troubles.
2. Preliminary Inspection of Receivers.
3. How to Check Power Supply.
4. How to Identify Various Stages of Receivers.
5. How to Trace the Circuit and Prepare Skeleton Diagram.
6. How to Test and Measure Voltages.
7. How to Test Speaker in Audio Stages.
8. How to Test Detector, I.F., R.F., and Mixer Stages.
9. Complete Reference Table for Quickly Locating Receiver Troubles.

VETERANS

During the war, National trained enlisted men under contract with the War Department. Both the Armed Forces Institute and Marine Corps Institute used our lesson texts on a wide scale. Now, we are training veterans, both resident and home study, through the Veterans Administration. If you are a veteran of World War II—and qualified for training under the G.I. Bill of Rights, check the coupon below for special information.



RADIO SHOP AT NATIONAL

BROADCAST STUDIO AT NATIONAL

Partial View of the Facilities that Stand Behind Your National Schools Home Training

TELEVISION STUDIO AT NATIONAL



We Bring NATIONAL SCHOOLS to You

Begin Training at Home Later Come to Our Shops and Laboratories in Los Angeles —If You Prefer

National's Master Shop Method Home Training in Radio, Electronics and Television is COMPLETE in itself. No other training is necessary; but, some men do prefer to take a short experience course here in our resident shops and laboratories, at the end of their Home Study training. They find it helpful to spend a short period of time in our modern Broadcasting Station, or our New Television Laboratories and Studios, or our Extensive Radio Servicing Shops—as well as other departments covering every specialized phase of the Radio Industry.

You are welcome to take advantage of this additional instruction if you wish. If you are interested, check the coupon below. Full details will be sent you by return mail. National Schools' **OUTSTANDING FACILITIES MAKE IT POSSIBLE TO OFFER THE FINEST POSSIBLE TECHNICAL TRADE TRAINING IN RADIO, TELEVISION AND ELECTRONICS.**



You Get All This Radio Experimental Equipment to Use and Keep at Home!

LEARN BY DOING is the basic principle of National's Shop Method Home Training. We send you standard Radio parts for an interesting series of experiments which demonstrate the fundamentals of Radio, Television and Electronics. The very essence of this training is **EXPERIENCE**—you get actual experience by building many different types of circuits. You build a fine, long distance **MODERN SUPER-HETERODYNE RECEIVER**, signal generator, low-power Radio transmitter, audio oscillator, etc. This practical work develops your knowledge of Radio step by step, makes you a practical Radio Technician.

G. I. APPROVED

NATIONAL SCHOOLS

LOS ANGELES 37, CALIFORNIA EST. 1905



MAIL OPPORTUNITY COUPON FOR QUICK ACTION

NATIONAL SCHOOLS, Dept. 10-RC
4000 South Figueroa Street, Los Angeles 37, California

Mail me FREE the two books mentioned in your ad, including a sample lesson of your course. I understand no salesman will call on me. I have checked below the plan which interests me.

NAME AGE

ADDRESS

CITY STATE

(Include your zone number)

I am interested in home study only.

Send information on your Combined Home-Study and Modern Resident Shop Training.

Veteran of World War II.

OCTOBER • 1947

Editorial: Radio Gadgets	by Hugo Gernsback	17
Radio-Electronics Monthly Review		18
Radio Thirty-Five Years Ago		83
Housewives and Television	by S. Heller	31

Electronics

Ploughing by Radio	by S. P. Osborne and R. W. Dunn	20
Magnetism—Part I	by A. C. Shaney	28

Amateur Radio

250-Watt FM-AM Transmitter, Part IV—The Speech Amplifier Circuits	by Harry D. Hooton, W3KPX	27
10-Meter Converter Requires No Tuning	by Daniel Schulman and Nathan G. Dorfman	30
Shortwave Rotary Antenna	by Carl V. Hays, W6RTP	34

Servicing

A Useful Tube	by Eric Leslie	23
Plastic Cabinet Straightening	by Max Alth	26
Radio Set and Service Review—National NC-173		32

Test Instruments

Field Strength Meter	by George E. Roush	22
Old Tube Tester Is Still Useful	by H. Leeper	36

Construction

Carrier Radiophone—Part I	by Bob White	24
"Scotch Receiver" Includes a Lamp	by Homer L. Davidson	35
Thyratron Receiver for Remote Control	by Edwin Bohr	37
A Cathode Follower	by Robert M. Crooker	37

Departments

Transatlantic News	by Major Ralph W. Hallows	38
World-Wide Station List	Edited by Elmer R. Fuller	40
New Radio-Electronic Devices		42
Radio-Electronic Circuits		44
Try This One		46
The Question Box		48
New Radio-Electronic Patents	Conducted by I. Queen	50
Technotes		68
Communications		84
Book Reviews		87

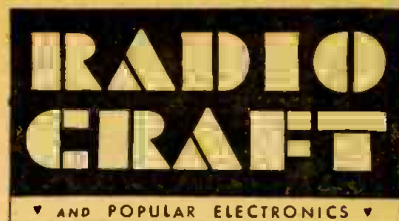

Incorporating
SHORT WAVE CRAFT TELEVISION NEWS
RADIO & TELEVISION

HUGO GERNSBACK

Editor-in-Chief

FRED SHUNAMAN, *Managing Editor*

M. HARVEY GERNSBACK,
Consulting Editor

ROBERT F. SCOTT, W2PWG,
Technical Editor

ANGIE PASCALE, *Make-up Editor*

I. QUEEN, W2OUX, *Editorial Associate*

ELMER FULLER, *Shortwave Editor*

G. ALIQUO, *Circulation Manager*

JOHN J. LAMSON,
Advertising Director

ALFRED STERN, *Promotion Manager*

In An Early Issue:

SELLING HOME RECEIVERS
TUBE TESTER MULTIMETER
A 4-TUBE FM RECEIVER

On the Cover:



Harry D. Hooton, W3KPX
and the AM-FM transmitter
which he is now describing
in RADIO-CRAFT.

Chromatone by Alex Schomburg



RADCRAFT PUBLICATIONS, INC. Hugo Gernsback, President; M. Harvey Gernsback, Vice President; G. Aliquo, Secretary

Contents Copyright, 1947, by Radcraft Publications, Inc. Text and illustrations must not be reproduced without permission of Copyright owners.

RADCRAFT PUBLICATIONS, INC. • PUBLICATION OFFICE 29 Worthington Street, Springfield 3, Mass. • EDITORIAL AND ADVERTISING OFFICES 25 West Broadway, New York 7, N. Y. Telephone REctor 2-9690.

BRANCH ADVERTISING OFFICES: Chicago: 308 W. Washington Street, Chicago 6, Ill. Tel. Randolph-7363. Cleveland: Burdette Phillips, Manager, 405 Erie Bldg., Cleveland, Ohio. Tel. Main 9645. Detroit: Frank Holstein, Manager, 307-8 Boulevard Bldg., Detroit, Mich. Los Angeles: Ralph W. Harker, Manager, 606 South Hill St., Los Angeles 14, Calif. Tel. Tucker 1793. San Francisco: Ralph W. Harker, Manager, 582 Market St., San Francisco 4, Calif. Tel. Garfield 2481.

RADIO-CRAFT, October, 1947, Volume XIX, No. 1. Published Monthly on 28th of month preceding date of issue. Allow one month for change of address. When ordering a change, please furnish an address stencil impression from a recent wrapper. All communications about subscriptions should be addressed to the Circulation Manager, Radio-Craft, 25 West Broadway, New York 7, N. Y.

SUBSCRIPTION RATES: United States and possessions, Mexico, Central and South American countries, \$3.00 a year; 5.00 for two years; \$7.00 for three years. Canada, \$3.50 a year; \$6.00 for two years; \$8.50 for three years. All other foreign countries, \$3.75 a year; \$6.50 for two years; \$9.25 for three years. Entered at Post Office, Springfield, Mass., as second-class matter under the Act of March 3, 1879.

FOREIGN AGENTS: Great Britain: Atlas Publishing and Distributing Co., Ltd., 18 Bride Lane, Fleet St., London E.C.4. Australia: McGill's Agency, 179 Elizabeth Street, Melbourne. France: Brentano's, 37 Avenue de l'Opera, Paris 2e. Holland: Technisch Bureau Van Beerle, Bemelmans & Co., Heemsteedsche, Dreef 124, Heemstede. Greece: International Book & News Agency, 17 Amerikis Street, Athens. So. Africa: Central News Agency, Ltd., Cor. Rissik & Commissioner Sts. Johannesburg; 112 Long Street, Capetown; 369 Smith Street, Durban, Natal. Universal Book Agency, 70 Harrison Street, Johannesburg. Middle East: Steimatzky Middle East Agency, Jaffe Road, Jerusalem. India: Magazines Distributors, 5 Bombay Mutual Annexe, Gunbow Street, Fort, Bombay 1.

TELEVISION-

**America's Next
Giant Industry?**



Billboard Announcing Telecasts of
Ball Games in Chicago



U. A. Sanabria

Dr. Leo deForest

The Men Who Direct American Television

The instructional quality of training is under the constant personal supervision of two internationally known engineers, Mr. U. A. Sanabria, President and Founder of American Television, Inc. and Dr. Lee deForest, the famed inventor of the radio tube.



FREE PRE-ENTRANCE COURSE

A Short Home Study Television Course is available to qualified war veterans who are considering residence training. This course is free of any charge or obligation. Your success with it will help you to learn your own abilities in television. It will also aid us greatly in qualifying you for residence training. Your acceptance of the Home Study course in no way obligates you to enter our residence school. So we urge you to take advantage at once of the very unusual opportunity it offers.

Today, **RIGHT NOW**, clear and bright pictures of great sports events, as well as other equally interesting programs, are being telecast for the enjoyment of thousands. Television stations in New York, Chicago, Philadelphia, Washington, Detroit, St. Louis and Los Angeles are already operating on regular schedules. Construction has started in several other centers and it is believed that practically every major city in the country will have this wonderful service before the end of 1948.

Who will build, maintain, and operate the new telecast stations? Who will design, produce, install and service the receivers?

Men Must Be Trained for These New Professions

Alert young men with an ambition to grow with television are training now in the greatly enlarged instruction laboratories of American Television, Inc. A wide choice of courses available. Advanced methods and latest obtainable equipment used.

Approved for Veteran Training Under G. I. Bill of Rights

American Television, Inc.

5050 BROADWAY

CHICAGO 40, ILLINOIS

REQUEST FOR FREE INFORMATION

American Television, Inc., Dept. of Information
5050 Broadway, Chicago 40, Illinois
Please send details of your Television Training.

NAME _____

ADDRESS _____

CITY _____ ZONE _____ STATE _____

I am a veteran



One of Our New Buildings.
Air Conditioned the Year Round.

"Communications" OFFERS:-

MICROWAVE TUBES

3J31 (1cm)	\$17.50
Magnet for above	8.00
2J26 (10 cm)	25.00
2J32 (10 cm)	25.00
2J38 (10 cm with Magnet)	37.50
WE700A (L band)	45.00
WE720BY (S band 1000 KW)	25.00
2K25-723AB Klystron	7.75
QK 59, QK 60, QK 61, QK 62 Tunable packaged Magnetrons (10 cm), each..	45.00



RC 145-154 to 186 mc., 117 VAC, 1KW pulse output with Power supply and Indicator with Selsyn for beam control. Plenty of room for exciter stages. Includes blower and rack. 39 5/16" x 26 3/4" x 20 1/2". New \$200

RC 148, consists only of transceiver and power supply. Both units with tubes slightly used. \$47.50

Antenna for same, new..... 47.50

RADIOSONDE TRANSMITTER with 3A5 tube made to hang on parachute. 4 1/4" x 2" x 2". \$2.75

BC191 & 375 Transmitters

Used condition. Supplied with one tuning unit of frequency closest to your request. The best buy in surplus. \$9.95

DYNAMOTORS

For that EMERGENCY rig:

DM-21: In 14VDC 3.3A Out 235VDC 90ma with filter	\$2.59
DM-25: In 12VDC 2.3A Out 250VDC 50ma.	\$2.49
DM-34: In 14VDC 2.8A Out 220VDC 80ma.	\$2.49
DM-42: In 14VDC, Out 515/1030VDC 215/260 ma & 2/8VDC	\$3.95
BD-77 input 14VDC, output 1000V 350ma DC.	\$5.95

Hand Generators

GN58 425V .115a. 6.3V 2.45a and 105V 32ma. 1.4V .45a	\$7.95
GN-35 output 325-365V 100ma, 8V 2.5A or 380-420V 70ma, 10V 1.25A	\$3.50

Signal Generator—2700 to 2900 Mc. Regulated power supply—115V/60c. Contains output meter. With circuit diagram. Value \$400. Our Price \$50.00



Headgear Dynamic Mike and Headset Combination, sound powered. No batt. required. Mike and earphones. Complete. \$2.75

New, U.S. Air Corps insert type HS30, comfortable, lightweight, efficient 500 ohms85

Output trans. to match 500 to 8000 ohms..... .35

MICROWAVE PLUMBING

1.25 CENTIMETER

Wave Guide Section 1' cover to cover.....	\$2.00
T Section choke to cover.....	4.50
Mitred Elbow cover to cover.....	3.00
Mitred Elbow and "S" sections choke to cover	3.50
Flexible Section 1' long choke to choke.....	3.00
Tunable Cavity with Coax input and output.....	6.00

10 CENTIMETER

Sand Load (Dummy Antenna) wave guide section with cooling fins, app 23" high.....	28.00
Wave Guide to coax with flange, gold plated app 10" high.....	17.50
10 CM Dipole with bar reflector 3" high, S.P. coax conn.....	2.75
Rigid Coax Directional Coupler CU-90/UP20 DB drop, has short right angle, about 8".....	5.50
Standing Wave Detector rigid coax 58 ohms.....	5.00
Coax Rotary Joint with mounting plate.....	8.00
Antenna in lucite ball, for use with parabolic.....	5.00
Flexible Coaxial Connector, rigid coax to rigid coax 7/8" diam.....	2.50

3 CENTIMETER

T Sections.....	5.50
Wave Guide Sections 2.5' long, silver plated with choke flange.....	5.75
Wave Guide 90 deg. bend E plane 18" long.....	4.00
Wave Guide 90 deg. bend H plane with 20DB directional coupler.....	4.75
Wave Guide 18" long "S" curve.....	2.00
Feedback Dipole Antenna, choke input (used with parabola).....	4.50
Rotary joint wave guide in/out choke to choke joint	6.00
Rotary Coupler choke input; round guide output.....	5.25
S-Curve Wave Guide 8" long cover to choke.....	2.50
Wave Guide 2.5' long, silver plate, 180 deg. bend choke to cover.....	5.95
Duplexer Section using 1B24.....	10.00
Wave Guide with slotted section and rotary joint	4.00
Wave Guide 5' length per foot.....	1.50
Pick-up loop with adjustable tuning section, used in duplexer.....	1.50
3 CM Wavemeter Maguire No. 1539TFX.....	20.00

THERMISTORS

D167332 bead	\$0.95
D170396 bead95
D168391 button95
D167613 button95

RELAYS

MINIATURES

SPDT 24 VDC	\$.40
SPST 28 VDC40
DPDT 28 VDC40
SPST 100 V Overload 380/1800 cy40

TELEPHONE TYPE

SPDT with cover	\$1.05
DPST	1.05

MISCELLANEOUS TYPES

SPDT 5 VDC in can 5 per base	\$.85
DPDT 6 VAC Struthers Dunn	1.45
DPST 6 VAC Struthers Dunn	1.35
2 sect SPDT 6 VAC Wheelock type	1.10
SPDT 115 AC Leach	1.00
SPDT 115 AC WE Wheelock type	1.26
SPDT 115 AC Kurman latch	2.49
SPDT 115 AC GE with SPST thermal delay section	1.95
DPST 24 DC Allied75
DPDT Leach ANT with SPST rec sect 24 DC & 12 DC	1.25
4PDT 24 VDC GM85
Solenoid Contactor 24 VDC Leach	1.05
Thermal Delay 45-60 sec Edison 1503 w 4pr base	2.95
6 VDC Relay Panel with 3DPST & 2SPST on 10" x 7" Panel	2.25

Complete Shipboard Radar Sets

• MFRS. Send your requirements for Bathtubs, Micras, Resistors, Koolohms, Connectors, Hardware.

• Mail order promptly filled. • All prices F.O.B. New York City. • Send Money Order or Check. Rated firms send P.O. Shipping charges only sent C.O.D.

Ask For Our Latest Catalog
COMMUNICATIONS EQUIPMENT CO.

131-C Liberty St., N. Y. City 7, N. Y.
Dlgy 9-4124

MINE DETECTOR AN/PRS I



Will indicate buried metallic and non-metallic objects. Includes detector unit, amplifier in case, all tubes, cables, etc. New, complete \$12.75
With batteries \$20.75

TRANSFORMERS

Power Pair—Use 2 for FW 1900V CT at 350MA pri 117V 60 cycle—3 Taps. EA Transf is cased 950V NCT. Per pair..... \$10.00
All Primaries 117V 60cy Secondaries:

No. 5084—1000V CT @ 250ma, 6.3V @ 1.5A.....	\$6.95
No. 5190—6180V @ 200ma.....	\$14.75
No. 5087—6.3CT 1A, 5V CT 3A, 5V CT 3A.....	\$2.75
No. 5104—6.3V @ 1A, 6.3V @ 1A, 6.3V @ 1A.....	\$2.45
No. 5126—5V CT 3A, 5V CT 3A, 5V CT 6A.....	\$3.25

CHOKES

Amertran—RMS test 15KV, 1 Hy. .8 amp DC, DC resistance 7.5 ohms.....	\$8.95
8.5 Hy. 125ma, 1780V Test.....	\$1.45
Dual: 7Hy. 75ma, 11 Hy. 60 ma, 1780V test.....	\$1.95
6 Hy. 150ma	\$2.00

(Conservative Ratings)

OIL CONDENSERS

SPRAGUE AEROVOX, C-D

15 mf 220 AC 600 DC	\$ 1.75
5-5 mf 400 DC	1.05
.1-1 7000 DC GEpyr	2.00
Lots of 50	1.50
10 mf 600DC85
1 mf 1000DC75
2 mf 1000DC89
4 mf 1000DC	1.00
2 mf 660AC85
1 mf 3000DC	4.95
1 mf 7500DC	12.50
.25 mf 20000DC	17.50
2 mf 1000DC Sprague Electrolytic.....	.50
1MF 400V30
1MF 600V35
2 mf 600DC CD40
200 mf 250DC	2.00
4000 mf 30DC CD	2.50

MICAS

.002 mf 15000V Sangamo	\$20.00
.002 mf 6000V	8.50
.005 mf 15,000V	22.00
.006 mf 10,000V	17.50

B29 Computer Amplifier. Contains 8 relays, 8 6SN7 tubes, 5 neons, 1 6X5. Completely wired with all components. New..... Only \$9.95

TUNING UNITS



From BC191 and BC375 contains coils, chokes, dials, condensers. Range 400 Kc to 12.5 Mc. State your approx. freq. \$2.75

Tuning Units for TCE & GP7 in following freq.: A-350-800Kc, B-800-1500Kc, C-1500-3000Kc, E-4525-6500Kc, F-6200-9050Kc. Contains all coils, etc. Complete set of 5 \$11.00

Units C or F. Each 2.75
Units A, B, E. Each 2.00

You can be a BROADCAST TECHNICIAN or ENGINEER...



ADD TECHNICAL TRAINING TO YOUR PRACTICAL EXPERIENCE

Use CIRE Training and Coaching Service—and Get Your “Ticket” in a Few Short Weeks!

Employment opportunities are plentiful—Now is the time to get in on the ground floor—Permanent employment—steady, good pay—Advancement to those who are qualified—These are only a few of the attractive features of this interesting, pleasant employment!

Get your license without delay—Let Cleveland Institute prepare you to pass the FCC license examinations, and to hold the jobs which a license entitles you to, with CIRE streamlined, post-war methods of coaching and training.

Your FCC Ticket Is Recognized in ALL Radio Fields as Proof of Your Technical Ability.

More than ever before an FCC Commercial Operator License is a sure passport to many of the better paying jobs in this New World of Electronics.

Employers frequently give preference to the license holder, even though a license is not required for the job. Hold an FCC “ticket” and the job is yours!

HUNDREDS OF SATISFIED, SUCCESSFUL STUDENTS

“I have taken the first class phone license examination and received my first class ticket last Saturday May 31. In closing I must say yours is an excellent radio course, and I really appreciate your help and the fine service you have rendered me.”

Student #2876N12

“I passed the FCC examination in radiotelephone 2nd class, at Detroit on June 3rd, and I want to thank you for your ready assistance as my instructor on Section I of Nilson’s Master Course.”

Student #2779N12

“I have had my 1st class radiotelephone license since March of this year, and plan to continue with your course since I find it a great help in studying transmitters.”

Student #2779N12

“After sending in Lesson E-9 I took the commercial operator’s license examination for 2nd class radiotelephone, and passed O.K. I received the license last week.”

Student #2772N1

FREE BOOKLET—Tells you the Government requirements for all classes of FCC COMMERCIAL licenses. (Does not cover Amateur License examinations). Use coupon below for Booklet B.

OTHER CLEVELAND INSTITUTE HOME STUDY COURSES OFFER COMPLETE TECHNICAL RADIO TRAINING FROM LOW-LEVEL TO COLLEGE-LEVEL, FOR THE RADIOMAN WITH PRACTICAL EXPERIENCE!

COURSE A—MASTER COURSE IN RADIO COMMUNICATION

A complete course covering the technical fundamentals of radio-electronics, for the radioman who wants a general review. Includes preparation for Broadcast station employment.

COURSE B—ADVANCED COURSE IN RADIO COMMUNICATION ENGINEERING

A genuine college-level radio engineering course, completely mathematical in treatment. For the advanced radioman with considerable practical experience and training.

COURSE C—SPECIALIZED TELEVISION ENGINEERING

An advanced college-level course for the radioman who has had formal training equivalent to A and B.

These three courses in radio-electronics offer a complete, thorough technical training for the radioman who wants to cover the field. Available separately or combined.

FREE CATALOG—Describe all Cleveland Institute home study courses—tells of CIRE unique, post-war methods of training. Use coupon below for Catalog A.

How To Pass
FCC
LICENSE
EXAMINATIONS
CLEVELAND INSTITUTE
OF
RADIO ELECTRONICS
Terminal Tower - Cleveland, Ohio

HOW TO PASS Commercial Radio Operators' FCC LICENSE EXAMINATIONS...

CLEVELAND INSTITUTE OF RADIO ELECTRONICS

Contractors to the Canadian Broadcasting Corporation

RC-10 TERMINAL TOWER

CLEVELAND 13, OHIO

CLEVELAND INSTITUTE OF RADIO ELECTRONICS
RC-10 TERMINAL TOWER, CLEVELAND 13, OHIO

Veterans check for enrollment information under G-1 Bill. NO OBLIGATION — NO SALESMEN.

Gentlemen: Please send me your Booklet B, “HOW TO PASS THE FCC COMMERCIAL LICENSE EXAMINATIONS,” and information about your home study course for preparation for FCC License Examination. (Does not cover Amateur license examinations.)

Please send me your Catalog A, describing all of your home study radio-electronics courses. I desire training in course A B C.

NAME

ADDRESS

CITY

ZONE

STATE

Don't Delay—
Write Today!

Approved
for Training
under
“G-1 Bill
of Rights”



Hershel's Gift to the Radio Widow

MAKE YOUR YL OR XYL HAPPY—THIS BEAUTIFUL 8 Pc. CASSEROLE SET FREE WITH EVERY PURCHASE OF \$5.00 OR MORE—This Offer Good For a Limited Time Only

WITH COUPON ONLY

Genuine GLASBAKE—Endorsed by Good Housekeeping.

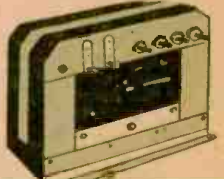
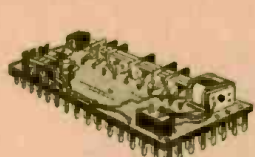
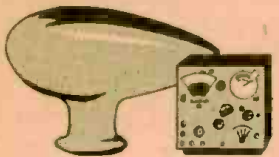

Brand New Automatic Direction Finder RADIO COMPASS

SCR-269 F COMPLETE WITH COMPONENT PARTS **\$75.00** NO. OT-100

The radio compass SCR-269-F was designed to be the primary radio navigation compass for the United States Army and Navy Air Forces. Constant reception is possible day or night so that fixes can always be made to establish the plane's or ship's location.

Plotting fixes is accomplished by selecting two or more stations and plotting these on the navigation map. The point of intersection of these lines indicates the location of the craft.

This equipment comes complete with 17 tubes superheterodyne receiver which is tunable from 200-1750 KC in three bands. A complete instruction book for operation and maintenance accompanies this equipment.

NEW BC-223 AX TRANSMITTER

\$14.95 NO. OT-109

Complete with tubes and tuning unit covering 80 meter Ham band. Including frequency charts, less Xtals.

BK22K Relay

\$2.95 NO. OT-110

Used in conjunction with SCR269F, changeover contains 29V. step relay, 5 deck, 6 position switch, 12V D.P.S.T.

IKW MODULATION TRANSFORMER

\$14.95 NO. OT-111

ICA Mod. Trans. continuously rated at 350 Watt audio to modulate this new KW High Audio. Wm. 250 W. 11-40 300 Sec. 2-80 300 Sec. 1-11 1st Pri. Sec. 2-250 351. 1st Pri. Sec. 2-250 351. DC Resistance—Pri 133 ohms Sec 1-112 ohms Sec 2-99 ohms. Transformer insulation tested: Pri. 8000 V. Sec. 1-11-1000V. Sec. 2-2000V. to the rest of this unit and dem. Primary center-tapped for Class 'B' modulation. Secondary 2-00 20 10 100 200 ohm-100 ohm series of beam power or screen grid tubes. Primary will match any Class 'B' tubes up to 10,000 ohm plate to plate, such as 610's, 731's, 800's, 28 100's, 203's, 8V31's, 813's, 82's, 805's, 203E's. Size 9 1/2" wide, 7 1/2" deep, 7 3/4" high. Heavy channel iron mounting brackets. Weight approx. 40 lbs.

EXTRA SPECIAL! R.L.T. Tube Tester

\$39.95 NO. OT-108

Tests all tubes up to 117 V
Tests shorts and leakages
Tests individual sections
Works on 90-125 V 60 cycle AC
Comes in portable cabinet complete with all operating instructions.

BUY FROM HERSHEL & SAVE!

VARIABLE CONDENSER

6 Gang silver plated, Sec. 1: 350 M.M.F.D., Sec. 2: 3, 4, 5, 60 M.M.F.D., Sec. 6: 60 M.M.F.D. NO. OT-101

89¢

SQUIRRELCAGE BLOWER

2" outlet, 110AC, 60cy Silent Ball Bearing Motor, with mounting bracket NO. OT-164

\$7.95

ARR7 Air Borne VERSION OF HALLICRAFTER SX28A

129.00 NO. OT-112

With 3 AF stages (two in reduction capacitor set), 12 tubes, Motor and manual wiring, S-meter, Frequency control, crystal filter, AVC, phasing control, AM, etc. Also includes video output for scope, and automatic output for recording. Complete with tubes and DC, but without power supply. Power requirements: 270w at 125 ma. Never in sealed case.

FREQUENCY METER BC-439

\$24.50 NO. OT-113

Xtal controlled check points. Frequency range 100 MC—120 MC, including 5 tubes and Xtals. Operates from 110 V, 60 Cyl supply. Ideal precision instrument for high frequency measurement. Used in good condition.

CORONA BALLS

Grid and plate contacts
Made for VE 127-250
The new Round Ball type heat dissipating silver plated.

10¢ OT-116
100 Doz.



FILAMENT TRANSFORMERS

110-V, 60 cy. Pri. sec.—5V—3A. Shelled Case. NO. OT-103 **\$1.49**

110-V, 60 cy. Sec. 2.5V at 3.25 amps. Shelled Case. NO. OT-102 **\$2.45**

110-V, 60 cy. Sec. 1, 5V at 10 amps.; Sec. 2, 5V at 10 amps.; Connected in series will give 10V at 10 amps. Shelled Case. NO. OT-106 **\$3.95**

SECONDARY FREQUENCY STANDARD

\$29.50 NO. OT-107

Complete with spare tubes 1000 KC to 45,000 KC. 1000—100—10KC
Check points.
100 to 250 V., 25-60 cycles.

IF TRANSFORMER

mounted in aluminum shield can, 1500 KC, w/ 1/2" air trimmer, impedance coupled type.

95¢ NO. OT-115

BN IFF TRANSMITTER & RECEIVER

\$9.95 NO. OT-102

Widely used on 144MC and now also successfully used as a television receiver, this being made possible by the wide band 30 MC I.F. channel and video amplifier being sold at this exceptionally low price for the encouragement of television. Original diagram furnished. Less tubes and power transformer, wt. 100 lbs.

BC-AR230 Transmitter

Including 4 tubes and RF Amps. meter.

BC-AL229 Receiver

Including 6 tubes. Used in aircraft.

BOTH UNITS FOR ONLY \$9.95 NO. OT-105

BC-654-A PORTABLE RECEIVER-TRANSMITTER

\$12.50 NO. OT-114

The frequency range of both transmitter and receiver is continuous from 3700 to 5800 kilocycles per second stages gang tuned by anti-back lash worm gear dial mechanisms. The BC-654-A is 18" wide, 14" high, and 9 1/2" deep. Weight 44 1/2 pounds. Power required for Receiver—1.5-4.5, and 90 volts D.C. Power required for Transmitter—11.5, 6, 51, 84 volts D.C. and 500 volts D.C. at 160 Ma. Operates from Dynamotor PE-103-A. Complete with carrying case.

CERAMIC INSULATORS

\$1.00 NO. OT-103 HIGH VOLTAGE FEED THRU

Scope Transformer

\$3.95 NO. OT-104

110V Pri: 60 cy, Sec: 4000 V at 10MA. Size 6 x 4 x 3 1/2

Shalleross AKRA-OHM WIRE WOUND

$\pm 1%$
1 MEG 89¢ NO. OT-165

SOCKETS FOR ACORN TUBES. NO. OT-117. . . . \$.19
POWDERED IRON 3/8 SLUG. NO. OT-118.10
JACKS—PL55, PL68. NO. OT-119.15
ASST. MICA CONDENSER, per 100. NO. OT-120. . . . 1.95
3 LBS. ASST. HARDWARE. NO. OT-121.1.00
PIN STRAIGHTENER for min. tubes. NO. OT-122.49
VARIAC IAMP. NO. OT-123.3.95
EAR PHONES, 2000 OHMS, used. NO. OT-124.95
JOHNSON SOCKETS #210-25W. NO. OT-125.39
5V FILAMENT TRANS. 60AMP. NO. OT-126.5.95
SCR 625 MINE DETECTOR. NO. OT-127. . . . 49.50

HERSHEL RADIO CO.

5249 GRAND RIVER AVE. DETROIT 8, MICH.

All Orders F.O.B. Detroit—Minimum order \$2.00—Mich. Customers add 3% tax.

FREE!

WITH EVERY
ORDER OF \$5.00 OR MORE
WITH COUPON ONLY

Genuine Spc. GLASBAKE Ovenware Set for the YL or XYL. HERSHEL'S GIFT TO THE RADIO WIDOW!

MICA CAPACITATOR **49¢**
002MFD, 3000 VDC
NO. OT-166

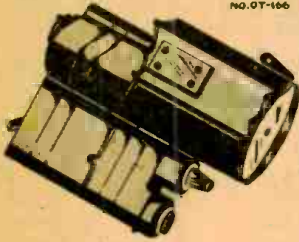

**SNIPERSCOPE
INFRA-RED DETECTOR**
\$100.00
NO. OT-133

This sensational sniperscope that was so widely used in World War II, to combat the enemy in night warfare, is now, for the first time, being released. This unit comes complete and ready to operate from 110V, A.C. or D.C. source—this being made possible by the use of the following tubes: 1G54—117N7—1P25 image tube. Rubberized carrying case included.

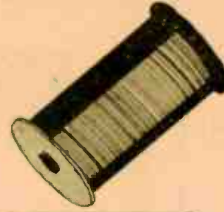

**COPPERWELD
#18 WIRE**
3000
FEET **\$2.95**
NO. OT-155



**HIGH SPEED PHOTO
FLASH TUBE**
\$8.95
NO. OT-156

12,000,000 lumens light output. Stops all action. Ignition coil included on back of bulb. 10,000 flashes. Diagrams furnished.

**PYRANOL
CAPACITATOR**
\$2.95
NO. OT-132

General Elect. 1 MFD.
5,000 VDC. 4" x 4 1/2" x 3 3/4"

**POWER
TRANSFORMER**
\$1.95
NO. OT-134

primary 110V, 60 Cy.
Sec: 700V each side of
center at 80 MA., 8.3V
at 12 Amps, 5V at 3
Amps. Hermetically
sealed. Size 6" x 3 1/2" x 2 1/2"

**POWER
TRANSFORMER**
\$1.95
NO. OT-144

110V, 60 Cy. Sec: 300V
ea. side of center at
125MA, 6.3V at 2.1
Amps, 5V at 3 Amps.
Hermetically sealed,
size 6" x 3 1/2" x 4 1/4"

**POWER
TRANSFORMER**
\$1.95
NO. OT-145

110V, 60 Cy. Sec.: 6V at
16 Amps, Sec. #2: 2 1/2V
at 1.75 Amps; ideal for 2x2
and 820 tubes. Hermetically
sealed, size 6" x 3 3/8" x
4 1/2"

**ROTARY TAP
SWITCHES**
KIT OF
6 SWITCHES **\$1.85**
NO. OT-154

**POWER
TRANS.**

110V, 60 Cy. Pri. Sec: 255V
ea. side of center at 80 Ma.,
5V at 4 Amps, 6.3V at 3.8
Amps. Hermetically sealed
case. **\$1.29**
NO. OT-153

**BUTTERFLY
CONDENSERS**

Oscillator assembly 76 to 300
MC with vacuum tube socket
mounted on condenser. **1.95**
Type B—frequency range **95¢**
300 to 1000 megacycles.
BC4 antenna condenser. **1.95**
105-330 MC. **1.95**
Oscillator 105-330 MC. **1.95**

LIP MIKE
WITH
HEAD BAND
AND
CORD **95¢**
NO. OT-131

**1 POUND
SOLDER**
60/40
ROSN
CORE **50¢**
NO. OT-135

**RESONANCE
INDICATOR**
with neon
bulb and
alligator
clip. **19¢**
NO. OT-146

**30 MC IF
TRANSFORMER**
29¢
NO. OT-157
SLUGGED TUNE

**250 MFD
AT 10V.**
ROUND CAN
5/8" x 2" **14¢**
NO. OT-136

**MATCHING
TRANSFORMER**
69¢
NO. OT-136

**COMPLETE HALICRAFTER
KNOB SET** **95¢**
FOR 5X20 NO. OT-143

**OVERLOAD
RELAYS**
\$1.95
NO. OT-161

Patent and Brumfield, Relay
#1, 5,000 Ohms, Coil Cur-
rent 10 MA., Relay #2,
110V, 60 Cy. AC coil
S.P.D.T.

**GENERAL ELECTRIC
METER**
\$3.95
NO. OT-158

type D041, 0-1
MA, meter scale
graduation 0-5
D.C. Kilo V and
0-10 MA D.C.

**SHORTING
TYPE**
INTERLOCKING
MALE AND
FEMALE **12¢**
NO. OT-139

**ELECTROLYTIC
Condenser**
6.8 MFD. ±10%
45 V D.C. Insulated
Lead wire mounted
round aluminum can.
95¢
NO. OT-137

IRC TYPE HE
49¢
NO. OT-147

100V, bleeder consisting of
5 sections, 750 Ohms, 23
Ohms, 23 Ohms, 7,500
Ohms, 3,000 Ohms. Total
11,296 Ohms.

**THORARSON
CHOKE**
\$1.85
NO. OT-152

at 200MA. Shell cased.

**T17 CARBON
MICRO-
PHONE**
LIKE NEW **89¢**
NO. OT-160

**DISCHARGE
RESISTOR**
General stock type
type 37, 130 V. A.C. or
D.C. **95¢**
NO. OT-138

**PAPER
COND.**
9¢
NO. OT-136

**VARIABLE
RESISTOR**
2500
OHM **49¢**
100
WT NO. OT-142

**TOGGLE
SWITCH**
39¢
NO. OT-151

D.P.D.T. 30 Amps. in
black bakelite-type
case

TUBES

813	5.95	872A	1.95
VR150	.69	9004	.65
955	.65	9006	.89
9002	.89	5085	.89
6J6	.95	829	2.95
RK60	.95	VT127A	2.95
9001	.89	35W4	.69
6J4	1.50	3AP1	2.95
5F97	2.95	3BP1	2.95
7AP7	3.95	6J5	.49
91P7	4.95	5BP1	3.95
6N7	.89	6H6	.59
1T4	3.04	6SN7	.59
354-SW4			
65A7-SU4	59¢		
12H6-1G5			
65H7	65¢		

**.05-.05-.05, 300
VDC, in round
can. Approx. 1"
x 1".**

**ELECTROLYTIC
Condenser**
39¢
NO. OT-140

30MFD., 100 WV.D.C.
round aluminum can,
plate type, 8% any
retail socket

**5 GANG VARIABLE
CONDENSER**
\$1.95
NO. OT-149

5 Gang, approx. 50
M.M.F.D. per sec-
tion with individual
air-tuned paddlers
18 to 1 vernier
drive.

CHASSIS
containing: 110 AC relay,
3 miniature sockets with
tube shields, 5 condensers
and 6 res. 3" x 5" x 1" **\$1.95**
NO. OT-150

**COLLINS FILTER
CHOKE**
6 MT. 150 MA. D.C.
res. 100 Ohms, Test
V 2500. **1.69**
OT-159

HERSHEL RADIO CO.

5249 Grand River Avenue
DETROIT 8, MICHIGAN

Please send me one 8 pc. casserole set FREE . . . For which I
am enclosing an order for \$5.00 or more on merchandise in
this ad.

NAME _____

ADDRESS _____

CITY _____

STATE _____

I understand that this offer may be withdrawn at any time. Sorry—offer
good only in U. S. A.

HERSHEL RADIO Co.

5249 GRAND RIVER AVE.

DETROIT 8, MICH.

All Orders F.O.B. Detroit—Minimum order \$2.00—Mich. Customers add 3% tax.

SPRAGUE TRADING POST

SWAP—BUY OR SELL

FOR SALE—Superior signal generator 160kc to 99mc, \$30; Precision 912P tube and battery tester, \$18. Enclose stamped addressed envelope. A. L. Hohn, Box 173, Morristown, Minn.

FOR SALE—New BC-457-A Western Electric transmitter 4 to 5.5mc complete with 4600kc crystal, tubes, one modulator unit and 25v dynamotor. Can be converted to a-c operation. Donnie Halls, Jamestown, Kansas.

SELL OR TRADE—Heavy duty transmitter; 6 & 12v. tubes to trade. Want toggle & push button switches and spring return S.P.S.T., S.P.D.T. and D.P.D.T. types. J. R. Reed, 2178 W 3rd St. Durango, Colo.

FOR SALE—Hickok new tube tester. 5321P. Cost \$121. Has latest tube chart, new condition. \$100. C. F. Chandler, 426 Larklin St., San Francisco, Calif.

FOR SALE—New tubes in cartons 60% off list: 6-1C8, 6-1D7, 6-1D8, 6-1E4, 6-1E7, 3-1G6, 6-1LD5, 6-6AC7, 6-6B8, 6-6C8, 6-6SD7, 6-6SH7, 6-6SF7, 3-6SR7, 6-7A4, 6-7A5, 6-7A6, 6-7E6, 3-7E7, 6-7H7, 3-7J7, 3-7N7, 3-7Y4, 3-12A5, 3-12A6, 6-12A8, 6-12H6, 6-12J5, 3-12SC7, 6-12SR5, 6-12SJ7, 6-12SL7, 12-14A7, 12-14B6, 24-14H7, 12-39/44, 12-50Y8. Southern Radio Service, Thomasville, Ga.

FOR SALE—Complete 100 watt CW rig 20-40-80 meters 6V6-6V8-P.P. 907 in Bud cabinet; also VFO duplicate 1947 Handbook. Want ART-13 or Metasner 150-B. Gus J. Guillot, WSHHB, Route 4, Box 278A, Beaumont, Texas.

FOR SALE—Hallcrafters 8-38 in A-1 condition. \$40. Power supply, 500-750v at 300 ma, \$60. David Bross, 200 W. Wyandot, Upper Sandusky, Ohio.

URGENTLY NEEDED—AC SW3 10 meter band spread coils, 60 series. Will trade general coverage 20 and 40 or pay cash. Frank Bou, W3ESX, c/o Bot. Dept., U. of Penna., 35th and Woodland Ave., Philadelphia 4, Pa.

WILL TRADE—BC-375E transmitter, complete with tubes, tuning units, dynamotor and mike. Want signal generator or good usable test equipment. James D. Bell, 515 N. Pelham, Jacksonville, Ala.

WANTED—Telefunken receiver, any model providing it will operate on 110v, 60 cycles a-c. Good shape but may be less tubes. All letters on Telefunken or other all wave foreign receiver will be answered. David F. Thomas, Proctorville, Ohio.

FOR SALE—Instruograph, tapes & new 600-1000 cycle oscillator; Thoriarson CHT 75 watt mod. transformer, T-11-M-75; RCA Aero dynamic microphone, 250 ohm imp; several buzz and other transmitting equipment. What do you need? W. A. Zuehlke, W8WKB, RFD #7, Box 356, Akron 3, Ohio.

FOR SALE—2 meter transmitter, 2 meter mobile, and receiver, also power supply, 1250v, 500 ma. and other transmitting equipment. B. F. Leyton, 3306 Arch St., Little Rock, Ark.

SELL OR TRADE—BC-222 walkie-talkie without battery but with adaptor and 110v a-c power unit; 25 to 82 mc frequency in good condition. \$30 or will trade for good V.O.M. Jim Lewis, 423 First St., Manistee, Mich.

FREE! This Giant Sprague TEL-U-HOW WALL CHART

—from your Sprague Distributor

Ask your nearest Sprague jobber for your copy of the SPRAGUE TEL-U-HOW WALL CHART. Just the thing for hanging on the wall of your shop. Its professional appearance impresses customers. The material it contains will help you do jobs easier, better, faster.

Beautifully lithographed in colors, size 22" x 28", the chart includes handy service application data; diagrams and descriptions of common circuit troubles involving capacitors; general replacement data on electrolytics; formulas; transformer, resistor and capacitor color codes; schematic; and similar invaluable service information. Everything is arranged for quick, easy reference. Popular Sprague Capacitors and Koolohm Resistors are illustrated. Don't miss it!



WILL TRADE—B.C. 221M frequency meter, spare crystal; RCA AVR 100A lightplane receiver, receiver broadcast, marker beacon, range stations, provision for loop. Uses portable batteries. Want B.C. 348, 8-40 or similar receiver or signal generator. William Brown, 586 Jamestown St., Philadelphia 28, Pa.

FOR SALE—HQ129-X complete with speaker, new. Morris Silberberg, 2175 Morris Ave., Bronx 53, N. Y.

WANTED—Hallcrafters SX9 receiver, white panel preferred. State price and condition. Matthew Healey, 681 Harris Ave., Providence 9, R. I.

FOR SALE—New BC610E Hallcrafters transmitter complete, in perfect condition. All inquiries answered. J. M. Buzzard, Terrace View Lane, Galena Road, Peoria 4, Ill.

WILL TRADE—Portable car radio and bench portable both with new batteries. \$7.95; gas model kit with engine and all accessories, \$55, also stamp collection. Want good ham receiver, Phillip Brand, 482 Fordham, Bay Village, Ohio.

FOR SALE—S-20R Sky Champion in excellent condition, 2 years old; also 10 meter pre-selector using an 1852 as in 1944 Amateurs Handbook. Both \$55, Roy Benson, 120 Broadway, Arlington 74, Mass.

FOR SALE—BC 603, 10 tube, push button 20 to 28 mc hi sensitivity receiver in excellent condition, \$15. V. Johannes, 1541 Metropolitan Ave., Bronx 62, N. Y.

SELL OR TRADE—SX-25 receiver with matching speaker, like new; brand new instruograph SR; 10 tapes. Want Riders, Sams Photo Facts, test equipment. What have you? F. E. Vaulciu, Box 540, Eugene, Ore.

SELL OR TRADE—Willcox CW3 receiver new, 5, 6-10 mc. fixed frequency, less crystal. Want Hallcrafters S40-A, RME-84, National NC-46. Charles Matzinger, 3630 22nd St., San Francisco 14, Calif.

WANTED—Jensen bass reflex speaker with 500 ohm input impedance. Give catalog number, price and condition in first letter. Have for sale, Abbott prewar TB-4 transceiver now on 2 meters, complete with tube, mike and Mallory vibropack, \$40, or will trade for Millen exciter. Allen L. Stratton, W8RTM, RD #1, Ballston Lake, N. Y.

FOR SALE—Latest RME 45-B, slightly used; factory inspected, accurately aligned, ready for use with speaker, \$169. Markley, 1260 Second Ave., San Francisco 22, Calif.

FOR SALE—National communications receiver with speaker, like new; NC-100, five bands, 200-400 mc. and 1.3 to 30 mc. continuous; mechanical bandspread; 8 meter calibrated to 40 db above 89, etc. \$150 plus crating & freight charge. Carl Lorman, 24705 Hawkett Dr., Euclid 17, Ohio.

FOR SALE—BC 312-G receiver complete and ready to operate, 110v, 600 a-c, has crystal phasing, \$35. L. H. Rice, 510 Louisiana Ave., Chester, W. Va.

WANTED—Hallcrafters E-200; Precision signal generator; good vibrator tester late model. 25B8 tubes; Riders manuals 10, 11 and 12. Barton's Radio & Electric Service, Route 1, Pontiac, Ill.

FOR SALE—Abbott DK3 transceiver complete with headset, less batteries. Used very little, \$22. Wm. E. Myers, R-1, Pierston, Mich.

SELL OR TRADE—1500 V.D.C. 500 ma. and 500v. 200 ma. power supplies on one rack chassis. R.F. chassis 6L6-307-PP T-40's, needs neat cond. Want National 1-10, NC-101X, HQ-120X, oscilloscope or what have you. All inquiries answered. Albert H. Renfro, 103 E. Maple St., Johnson City, Tenn.

FOR SALE—R44/ARR-5 airforce version of Hallcrafters R36-A. Covers old and new f-m bands also a-m stations from 43 to 144 mc. Never used. In original packaging, \$100, with a-c power supply. J. L. Andrews, Jr., Box 406, El Campo, Texas.

SELL OR TRADE—12v-10 amp supply from 110v, \$25, or Husky 6 volt supply from 110v. National NC44 receiver with speaker, \$50, or good signal generator, W8PFD, 907 14th St., Beaver Falls, Pa.

FOR SALE—Hallcrafters 8-19 sky buddy, receiver \$28 or will trade for A-C Instruograph, continental coils in new condition. Marvin J. Hayotek, Lakeside, Minn.

SELL OR TRADE—2 Gang variable condenser 5" pm speaker; tubes 6Q7, 6V6GT, 12SK7, 60L8, 12SQ7, \$4.50 or 6C5, 25Z5 and code practice set, Bobby Peck c/o Warren Wilson Junior College, Swanton, N. Carolina.

FOR SALE—Power transformer, (3x3x4") 390V-140 mill with two 6v. fl., \$3.50. Power pack with above transformer wired for two 6x5's, uses two C.D. 18-mfd. 450V can filters 46-8/8 x 93 1/2", \$5.95. H. S. Wyeth, 1923 Belmont Ave., Chicago 13, Ill.

SELL OR TRADE—PR-15 receiver in good condition. Want HI-FI—am & fm tuner. Murray Brown, 149 S. 4th St., Brooklyn 11, N. Y.

FOR SALE—Superior tube tester with instructions, good as new, \$17.50; new Radio-Automatic phone in portable case, \$78; New E.C.A. radio single player phone in tan portable case, \$44; 5 new 6v d-c-120v a-c vibrator transformers, 250v, 100 ma. when using 6x5 tube & 294 vibrator transformers, \$2.35 ea. May trade—what have you? Guaranteed Radio Service, 106 E. Main St., Independence, Kans.

WILL TRADE—Receiving tubes 9062, 9003, 11E5, 1N5, 1B4 and others; also radio service books, machinist's tools. Want good signal generator, V.T.V.M. or Riders manuals, Angelo F. DiMuccio, 37 1/2 Laurel Hill Ave., Bridgeton, R. I.

FOR SALE—Hammarlund super-pro Sp 400X including speaker and power supply. Used only few months, \$100. R. B. Horn, 645 Henderson Ave., San Luis Obispo, Calif.

POSITION WANTED—Radio television serviceman, 2 1/2 years' experience on radio, phonographs and electrical appliances. Would prefer vicinity of New York. T. P. Orlando, 2202 Glebe Ave., Bronx 61, N. Y.

FOR SALE—Transceiver transmitter with tubes, in case, less mike and antenna; transceiver receiver not in case but with good words on UHF in range, operates on 110 voltage, no power supply, \$30.50. Ellison Radio Service, Centertown, Ky.

YOUR OWN AD RUN HERE FREE

The Sprague Trading Post is a free advertising service for the benefit of our radio friends. Providing only that it fits in with the spirit of this service, we'll gladly run your own ad in the first available issue of one of the six radio magazines in which this feature appears. Write CAREFULLY or print. Hold it to 40 words or less. Confine it to radio subjects. Make sure your meaning is clear. No commercial advertising or the offering of merchandise to the highest bidder is acceptable. Sprague, of course, assumes no responsibility in connection with merchandise bought or sold through these columns or for the resulting transactions.

Dept. RC-107, SPRAGUE PRODUCTS COMPANY

North Adams, Mass.

(Jobbing distributing organization for products of the Sprague Electric Co.)

ASK FOR SPRAGUE CAPACITORS and *KOOLOHM RESISTORS by name!

*Trademark Reg. U. S. Pat. Off.

RADIO GADGETS

Fortunes Are Still To Be Made in Successful Radio Ideas

By HUGO GERNSBACK

WE hear continuously from many of our readers who come up with unusual radio ideas on which they seek our advice. Hardly a week goes by that a number of such letters do not pass across our desk.

There is, indeed, a good deal of money in radio gadgets, i.e., adjuncts to radio receivers. These gadgets are auxiliary items, performing some useful function in connection with radio receivers. They may or may not be electrical.

For the man who has little money, but who has original ideas, a successful business frequently springs from such a simple idea.

Consider that in this country there are now over 65 million radio sets. While the radio receiver performs the primary function of disseminating programs, that is by no means all it can do. The manufacturer who builds radio sets is interested only in supplying a receiver for listening purposes. Yet many radio set owners could very well have other effective uses for their receivers.

A parallel might be cited with the home or business telephone. Hundreds of gadgets have been invented as auxiliaries to the telephone, indeed many concerns have and are now making money from such devices. There is, for instance, a rubber device that clamps on to the telephone handset that enables you to place the handset on your shoulder while carrying on a conversation. The oval rubber block holds it in place so you have both hands free to write with and hold on to the writing paper. Another very widely-used gadget mutes your voice so that when you talk into the mouthpiece a person sitting near you cannot hear what you say. Such a device is often necessary in business when you do not wish to reveal to persons in the same room what information you are giving over the phone.

Another gadget for names and telephone numbers slides out of sight underneath the telephone set. When pulled out, the device gives you an alphabetic list of names and numbers. We could continue this catalog of similar phone gadgets, many of them highly successful, even though frowned upon by the telephone company.

There are many parallel opportunities in radio but, strange to say, radio technicians and inventors have hardly begun to exploit this great potential and most lucrative field.

Let us begin with the most obvious one. There is an urgent demand for a device for near-deaf persons and those hard of hearing who wish to enjoy their radio programs. The same is true for those who do not wish the set turned on too loud thus disturbing others in the same room. This is particularly the case in bedrooms. The wife or husband may wish to listen to a radio program while the other is sleeping. For this purpose, a few radio manufacturers have equipped a receiver with

a device such that a headphone or earphone can be connected to the set; but only a very few radio set manufacturers provide such a facility. It should be almost universal. For bedrooms there is also a pillow receiver that is placed inside or underneath the pillow so that one person may listen to a radio program without disturbing others in the same room. This is a particularly useful gadget not only for the home but hospitals as well.

The trouble with these items is that unless you know something about radio or call in a serviceman, you cannot connect such an earpiece to the radio set. That is probably the reason why these items are not sold in far larger quantities, as they deserve.

A much simpler gadget is needed, one that *anybody* can attach to *any* existing radio receiver without jacks and without making special connections. It will take a little ingenuity to solve this, but we believe it can be done.

We can think of one simple solution. A person hard-of-hearing could use a simple low-cost stethoscope, similar to those used by physicians. At one end would be earplugs and at the other a large diaphragm to catch the sound vibrations. Merely by placing this close to the loudspeaker by means of a simple attachment, a person so equipped could readily hear a program. This is a simple solution and does not require any electrical parts whatever. Even by turning down the radio set to a low volume, the near-deaf person still hears very well. We know, because we tried it. There may be other and better solutions.

In the early '30's several manufacturers designed a few radio toys which were highly successful at the time. Among them was a dancing figure which was placed on top of the radio receiver. A simple microphone placed near the loudspeaker energized a small electromagnet inside the dancer who then jiggled in unison with the radio's sound waves. The trouble with this toy was that it was much too expensive. Something of a similar nature that would sell around \$2.00 could very well make a little fortune for its maker. Indeed, it is not even necessary that the toy be electrical in nature. If you place your hand on the top of any radio, when turned on, you will feel the vibrations induced by the loudspeaker. Twenty-two years ago the writer described in one of his former radio magazines a dancing toy in which small figures, whose legs were three stiff bristles, danced slowly but effectively on top of a metal diaphragm, which was also the loudspeaker. That was long before we had such efficient and powerful loudspeakers as we have today. The same idea is still good: small dancing figures can be made to go through their motions right on top of any radio set. A simple metal guard will keep the dancing figures from falling over the side of the receiver. Such a toy could be sold at a good profit for \$1.00. Other similar ideas (Continued on page 82)

AUTOMATIC STEERING of road vehicles by electronic means is proposed in a patent (No. 2,424,288) issued last month.

The inventor, Victor Severy of Atlanta, Georgia, proposes to make motor vehicles automatically steerable by turning the job over to a photocell that will follow paint stripes running down the middle of the driving lane instead of along its side. From one side, underneath the vehicle, he throws a beam of light from a lamp with a reflector. This beam, thrown back to the photocell on the opposite side, actuates the steering mechanism whenever the vehicle tends to drift off course. A second set, with lamp and photocell placed opposite to the first, takes care of deviations in the opposite direction.

FM RECEIVER with only 3 tubes (plus rectifier) was announced to the public last month by Frank E. Shopen, W0WQE, general manager and chief engineer of KOAD, Omaha, Nebraska. The little set has been known for some time to the residents of Omaha and a large number are operating in that area.

The set is a superregenerator, and therefore lacks many of the advantages of a standard FM receiver. It cannot be expected to have either the quality nor the discrimination against unwanted stations that may be obtained from a good superheterodyne.

Mr. Shopen states that he constructed the receiver as a stop-gap until quantities of FM receivers should become available. Most of the users, having become acquainted with the high-fidelity characteristics of FM, would then very likely obtain sets which could reproduce FM in all its excellence.

Complete construction details of this receiver will appear in an early issue of RADIO-CRAFT.



The little F. M. radio. Quality is good, but of course not equal to that of larger receivers

RADIO-ELECTRONICS

Items Interesting to

A CAUTION given last month by the FCC to broadcasters warned that some stations have signed contracts that practically delegate to advertising agencies control of the station during certain programs.

In some instances, it was stated, contracts were entered into in which the agency was sold a block of time. The agency then sublet the time to various sponsors, arranged shows, and in at least one case used its own studios to produce the program.

No contract, the Commission warned, may delegate to others the station's responsibility for what it puts on the air.

BRITISH AMATEURS will not be permitted to act as United Nations radio aids, it was reported from London last month. The amateurs were to handle bulletins from UN destined for the public of all nations, as described in June RADIO-CRAFT.

The General Post Office has invoked a regulation which forbids any form of message transmission for the benefit of third parties, and will make no exception for United Nations traffic.

The matter will be brought up in the British Parliament where attention will be drawn to the present anomalous position of radio enthusiasts in England who technically are not even allowed to transmit SOS messages which they may have picked up.

SPECTROGRAPHY with the aid of a photocell extends the range of spectrographs far into the infra-red, Drs. Richard C. Nelson, R. J. Cashman, and Wallace R. Wilson of Northwestern University stated last month.

The new spectrograph developed by them is a combination of mirrors mounted on a heavy steel base. It breaks down infra-red light into separate wave lengths, just as a prism splits white light into its various component colors.

A photoelectric cell detects these individual wavelengths and converts the light energy into electrical energy which is recorded on a graph.

The scientists said that the new infra-red spectrograph almost doubles the range of atom-emitted light on which exact measurements can be made. With this spectrograph, which will give valuable information about the nature of the atom, observations that once took a month can now be made in an hour, they declared.

AMATEUR RADIO has organized to render even more effective aid in disasters than it has in the past, it was announced from Hartford last month by the American Radio Relay League.

A National Emergency Coordinator will in the future fly to any point where natural forces or man-made catastrophe have caused breakdown of the regular communications system. There he will facilitate the orderly integration of a complete emergency communications system, including spotting of portable self-powered "walkie-talkies" for short-haul traffic, the establishment at agency relief centers of radio stations powered by gas-engine generators and, if necessary, request of the Federal Communications Commission a special order clearing amateur channels exclusively for disaster communication, it was stated.

Assisted by local emergency coordinators, he will establish liaison with local officials of the American Red Cross, other relief organizations and protective services to handle their messages directing relief operations and keeping the outside world informed of the status of the emergency.

The first National Emergency Coordinator, Albert E. Hayes, Jr., W3LVY, was formerly an engineer with the Bendix Radio Corporation. He is a graduate of the Massachusetts Institute of Technology, a member of the Institute of Radio Engineers, and has been particularly active professionally in the electronic patent field.

MONTHLY REVIEW

the Radio Technician

RADIO GAS DETECTORS that *hear* and *see* the gases they detect were described last month.

The "seeing eye" detector is intended to detect carbon monoxide in airplanes. Patent 2,425,059 on the device has been awarded to William F. Fagen of Chicago, assignor to the Stewart-Warner Corporation.

A continuous sample of the air supplied to the plane's cabin is passed through a tube which contains a gel that turns dark blue in the presence of carbon monoxide. A light beam that passes through the gel in its normal state is dimmed, hence fails to excite the photocell on which it is directed. The change in current, suitably stepped up, operates a relay and gives warning.

Another instrument to analyze mixtures of gases was described at the recent Kansas City meeting of the American Chemical Society by Carl E. Crouthamel and Harvey Diehl of Iowa State College. The device analyzes mixtures of 2 gases by measuring the speed of sound waves that pass through a gas-filled tube. An audio-frequency oscillator sends waves at 1,000 to 3,000 cycles per second through a brass tube filled with the gas mixture. A sensitive microphone at the opposite end of the tube picks up the sound waves, analyzes them, and records the result on a meter.

FM BROADCASTS over a distance of 110 miles were demonstrated to delegates attending the International Telecommunications Conference at Atlantic City, N. J. The broadcasts originated at W2XEA-W2XMN at Alpine, N. J., and were transmitted to a receiving station at the Seaview Country Club, 7 miles from Atlantic City. A short section of high-fidelity wire line connected the receiving station to WBAB-FM in Atlantic City, from which the program was broadcast for the benefit of the delegates.

The tower at Alpine is 350 feet high, and the height of ground above sea level 850 feet. Distance of the horizon from the top of the Alpine tower is 37 miles. Thus the transmissions were sent over a distance 3 times the traditional line-of-sight range. The towers at Seaview are 120 feet high.

These results were not unexpected. The Alpine station's regular range approximates 90 miles (to rural receiving locations). The demonstration for the Telecommunications Conference was to break the superstition that FM and other high-frequency stations are limited to approximate line-of-sight ranges.

TRAIN TELEPHONE SERVICE between moving trains was inaugurated last month on trains between New York and Washington. Passengers on the Pennsylvania's Congressional Limited and the B. & O.'s Royal Blue simply call long distance in the usual manner to talk to any person connected in the regular telephone system.

The system is an extension of the automobile service now available in many American cities. The operator who answers the passenger's call is at the nearest automobile radiotelephone station, and the call is handled like any other mobile traffic.

Charges for long-distance calls are based on the standard person-to-person rates. Local calls are being charged for at a special rate which varies from 30 to 40 cents. Local calls are those made to areas within a zone of roughly 25 miles from any of the local radiotelephone exchanges, which are located at Newark, Philadelphia, Baltimore, and Washington.

JAMES G. HARBOARD, Lieutenant General (retired) of the United States Army and former president and chairman of the Board of the Radio Corporation of America, died August 20 at his home in Rye, New York. He was 81.

General Harboard was born in Bloomington, Illinois, March 21, 1866. He spent the greater part of his youth in Kansas and attended Kansas State Agricultural College. In 1889 he enlisted in the Army. During the war with Spain, he rose from lieutenant to major in the 2nd U. S. Volunteers. In 1902 he was sent to the Philippines, with the regular Army rank of captain, and was appointed colonel the following year. At the outbreak of the First World War, he was selected by General Pershing as his chief of staff and served with distinction as commander of the 2nd Division and head of the Service of Supplies, rising to the rank of brigadier general.

General Harboard applied for retirement from the Army in 1922 to become president of

PRIVATE BROADCASTERS were cracked down on by the FCC in Southern Indiana last month. As a result several so-called "carrier-current radio stations" used to broadcast Sunday church services have been shut down. Carrier current has been used for private broadcasting systems, especially in colleges, but it appears that the stations in question were radiating far more power than permitted by the regulations.

One station, "LQW," of Columbus, Ind., operating over power lines, was transmitting so much energy that its emissions interfered with standard broadcast stations. Other relatively high-powered "carrier-current" stations have been operating in the area to an extent that caused one radio inspector to brand Southern Indiana as a "hotbed of illicit radio activity."

Two churches in Bedford, Indiana, have been making plans with a local radio engineer for the installation of carrier equipment to broadcast services to their parishioners. Work has been temporarily suspended while the legality of their plans is discussed with the FCC.

FIVE MILLION RADIOS are now in operation in the Soviet Union, according to a last month's dispatch from Moscow. Another 600,000 sets will be installed this year according to the government plan, it was further reported,

RCA. He held that position until 1930, when he was elected chairman of the board. Ill health forced his retirement from that office a few months ago. He remained honorary chairman and a member of the Board of Directors until his death.



PLOUGHING BY RADIO

THIS BRITISH RADIO-CONTROLLED TRACTOR PLOUGH STARTS, STOPS, MAKES RIGHT AND LEFT TURNS AND CHANGES SPEED

By S. P. OSBORNE and R. W. DUNN*

RADIO control of aircraft, ships, and land vehicles has been developed hitherto almost exclusively for military or naval purposes, except of course in case of models. Last summer however, a well-known firm of British tractor manufacturers (Tractors Limited) conceived the idea of applying radio control to the more peaceful pursuit of farming and with the co-operation of Britain's Ministry of Supply and the Royal Aircraft Establishment the first successful radio-controlled tractor was demonstrated to the press. To the best of our knowledge this demonstration was the first in history in which ploughing was done by remote control.

The writers and their colleagues had been instructed by the Ministry of Supply to assist the firm with technical advice and supervise installation of equipment lent by the Royal Aircraft Establishment. The outfit was purely experimental. The object was to find out if it was possible to perform the tricky operation of ploughing by remote control with any reasonable degree of suc-

*Royal Aircraft Establishment (British)

cess. If so, it would probably be worth further development to produce a really flexible and reliable control system.

The tractor used was a lightweight model powered by a 7-horsepower engine. It is normally driven rather in the manner of a motor-driven lawn mower. There were 3 controls, the throttle, the turn-selection lever, and the forward and reverse selection lever.

It was decided, for the initial experiment, to omit automatic control for reversing, since this can be regarded as a refinement; but the other 2 controls must be selected and operated in co-ordination.

To turn the tractor the engine layshaft is disconnected from one or other of the 2 driving wheels by dog-clutches. Consequently any attempt to turn at full throttle results in an extremely rapid and uncontrollable rate of turn. The diameter of the turning circle is approximately the length of the tractor under these conditions.

A preliminary survey showed that the following requirements could be met:

1. Start and go straight at full throttle (about 4 miles per hour).

2. Do slow left and slow right turns at reduced throttle, with plough raised (about 1 m.p.h.).
3. Straight and reduced throttle with plough raised, as the result of demanding a turn.
4. Reversion to straight and full throttle with plough lowered.
5. Stop.
6. Provision for cutting out the plough-raising mechanism when other implements are attached to the tractor.

These requirements were all that could be met with the available equipment and with the existing dog-clutch arrangement incorporated in the tractor's turn mechanism. Servo systems were used for operating the throttle and turn controls, providing 3 possible servomotor positions. For example, servo "off" gave throttle closed, servo at mid-stroke gave half throttle, and servo fully opened gave full throttle. X in Fig. 1 shows the extreme position of the servomotor, and Y the half-throttle position.

Similar conditions were set up for the left, straight, and right positions of the dog-clutches. A separate, but much larger, servomotor was used to raise the plough.

Coordinated selection of the 3 servomotors—which operated from a compressed air supply at 80 pounds per square inch effected by 2 relay boxes, one of which (turn selection) was arranged specially for the tractor control. Incoming radio signals energized sensitive relays in the receiver. These in turn energized one or more of the above-mentioned relays in the main relay box, which contained 5 relays operating air valves in the pneumatic system. One valve (left turn) was reversed in that the air was turned off when the relay was energized; the reason for this will be explained later.

The sequence of operation and co-ordination of throttle position with turns were all produced by 4 combinations of 2 sensitive relays (X1 and X2) in the radio receiver:

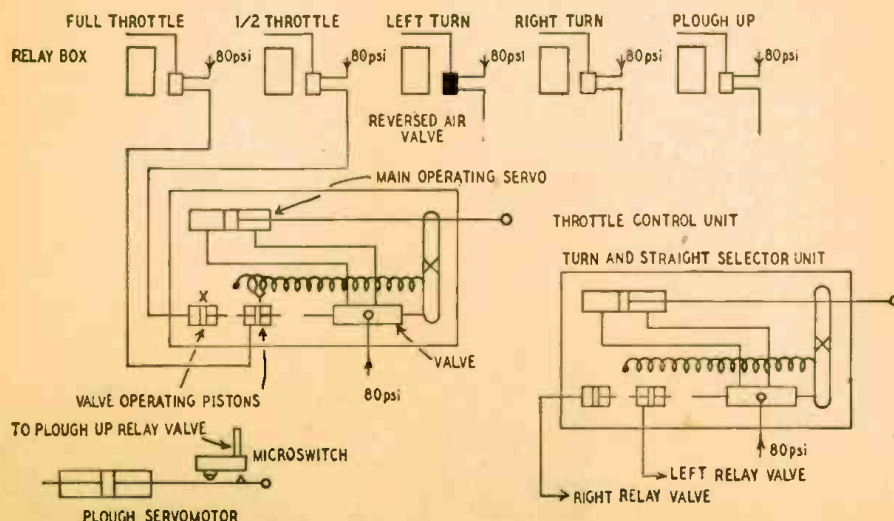

Fig. 1.—Pneumatic hookup of the system. The lines represent metal tubes or rods, not wires.



This picture shows the transmitting equipment for the radio plough.



The radio-controlled plough in actual operation, turning a furrow.

Item	Executive Signal (relays A and B)	Condition set up
1.	X1 and X2 not energized	Stop.
2.	X1 and X2 together	Start, straight, and full throttle.
3.	X1 alone	Right turn plus 1/2 throttle with delay until plough is fully up.
4.	X2 alone	Left turn plus 1/2 throttle with delay until plough is fully up.
5.	X1 + X2 (following X1 or X2 alone)	Straight plus 1/2 throttle.

The piping and wiring diagrams (Figs. 1 and 2) show quite clearly how the above conditions were met. The only points which need clarifying are that the delay in getting from full to half throttle when a turn was demanded was produced by feeding from T.L. (turn left) contacts through a microswitch located on the plough-raising mechanism and thence to half-throttle relay.

T.L. relay, once energized, was locked in electrically and could be unlocked only by switching off the radio transmission momentarily. Reversal of the left-turn relay-operated air valve meant that with X1 + X2 energized neither left- nor right-turn relays were energized; but since air was fed through the left-turn valve to the turn-selection servomotor, this took up a "servo control" position, which was "straight."

T.L. relay was slugged to a 500-millisecond delay so that any momentary hiatus in radio transmission would not be interpreted as a demand for a turn.

The following example of the sequence of operation may help the reader to follow the system more easily:

1. X1 + X2 = Full throttle plus straight plus plough down.
2. Demand left turn = X2 energized, X1 off. Left-turn relay energized plus T relay energized. = Air off left-turn valve.
- also 3. T energized = Left turn selected. = T.L. energized and locked in. = T.L. change-over contacts cancel full throttle in favor of half throttle via plough-up microswitch.
- = Left turn at half throttle.
- Later 4. X1 + X2 together = Straight but T.L. still locked. = Straight plus half throttle plus plough up.

Thus to get straight plus half throttle plus plough down, transmission must be stopped for about 1/2 second in order to unlock T.L. and so revert to condition 1 above.

The signal adopted was conveyance on the radio-frequency carrier wave of audio tones. Since the number of functions required was small, only 2 tones were used, giving 3 possible executive signals—a fourth obtained by complete lack of any tone was used as the "stop" signal.

The 2 tones used were 1,700 and 2,500 cycles per second. Both tones transmitted simultaneously were arranged to set up the initial conditions of straight and full throttle. Cancellation of one tone resulted in a demand for a

left or right turn, according to which tone was cancelled. The transmitting and receiving equipment used was of normal design; the carrier frequency used was 5 megacycles per second, which corresponds to a wave length of about 60 meters. The transmitter power was in the region of 30 watts, amplitude modulation being used. The depth of modulation was kept within the limits required for minimum distortion of the modulation envelope and was determined by the type of transmitter and receiver used and the number of tones transmitted simultaneously.

Since, in the case described, only a single or a double tone was used, the modulator consisted simply of 2 audio-
(Continued on page 54)

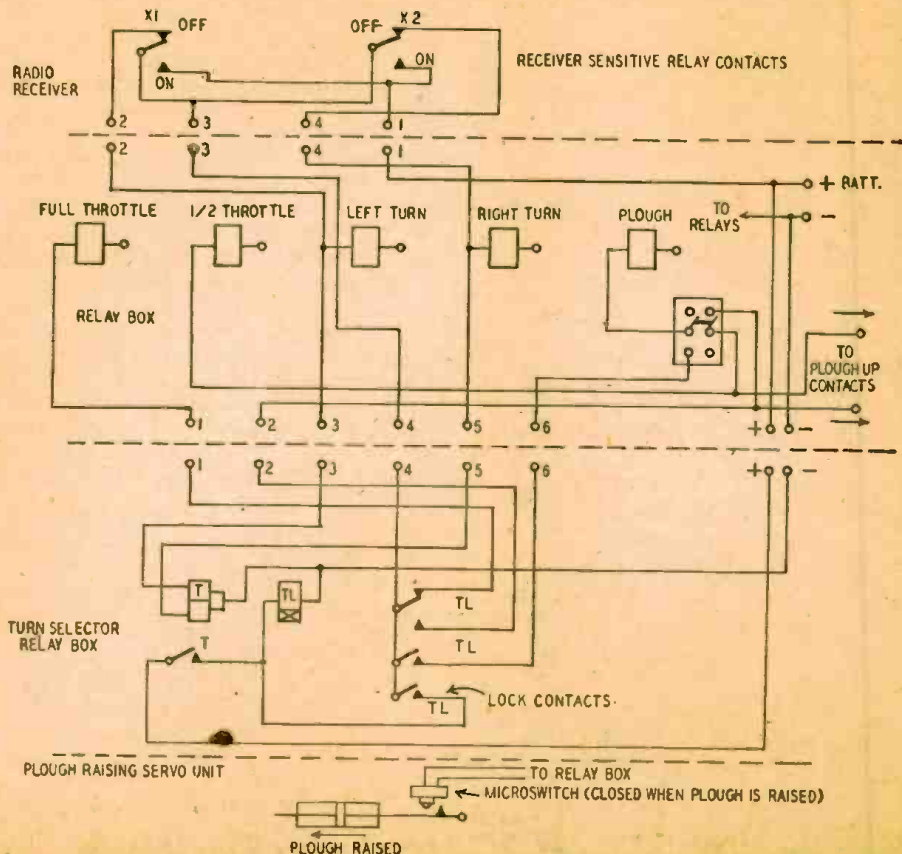

Fig. 2—Hookup of the electric relays. Portion above the dashed line is in the receiver.

FIELD STRENGTH METER

This inexpensive and useful two-function instrument should be a valuable addition to any amateur radio station's equipment

By **GEORGE E. ROUSH**

A CIRCUIT design which incorporates novel features into a well-known and reliable circuit results in this unit for the amateur station. It will aid in improving the efficiency of the station at lowest possible cash outlay. Next to the indispensable volt-ohm-milliammeter, the field-strength meter and simple wave meter shown in the photograph will fill the greatest need around the station.

A vacuum-tube voltmeter is desirable for checking the automatic gain control voltage of the station receiver but otherwise is not an absolutely essential part of the equipment. The unit was therefore designed also to measure those automatic gain control voltages for which a limited range only is required.

As shown in the diagram, the circuit comprises a 1E5 or a 1B4 tube with the screen connected to the plate. It operates as a biased-grid detector. The tube filament circuit is completed by a 3-volt battery connected in series with a rheostat R1 to drop the voltage to the proper value and a toggle switch S1 which opens and closes the filament circuit and thus serves as the OFF-ON control for the entire unit. A rotary FUNCTION switch S2 when thrown to the CALIBRATE position (uppermost as seen in the schematic diagram) connects the meter M in series with the multiplier resistor R2 across the filament terminals of the tube. The 4,000-ohm multiplier provides a reading of 0.5 ma (half-scale) when the filament voltage is the rated 2 volts. When switch S2 is thrown

to the OPERATE (lower) position, the meter is connected into the plate circuit and will indicate the intensity of any signal applied to the grid.

R. f. signals are applied to the grid by means of either an antenna or a primary coil coupled to a tuned circuit. Low alternating-current potentials are applied directly to the grid by means of a pair of tip jacks switched into the circuit by interchanging grid caps. A pair of headphones plugged into the plate circuit will allow the unit to be used as a phone monitor.

Construction and wiring

The unit is built on a U-shaped steel chassis mounted in a 9 x 6 x 5-inch cabinet. The lid is hinged for easy access when changing coils, adjusting the filament voltage, etc. The front panel is laid out around a Triplett 227-A meter and matching Millen disc dial. The dial is coupled to the tuning capacitor which is mounted on studs fastened near the center of the chassis. The tip jacks are mounted on a line between the ON-OFF switch located in the lower left-hand corner and the jack in the lower right. The plate battery is mounted on top of the chassis behind the meter; the filament and bias batteries are located beneath it on the underside. The tube and coil sockets are located on a line between the meter and the tuning capacitor. The FUNCTION switch and the filament rheostat (both of which are screw driver controlled) are mounted on the right-hand side of the chassis alongside the tuning capacitor. The antenna post, a feed-through insulator with a wing nut, is mounted on the back of the cabinet. A Fahnestock clip is mounted on the inside terminal of the insulator so that the lead to the capacitor can be broken and the chassis readily removed from the cabinet.

The coils are wound on 1½-inch forms, using No. 20 double-cotton-cov-

ered wire. The coils are not at all critical and the following table will serve as a basis:

Range (Megacycles)	Number of Turns	
	Tank (L1) Link (L2)	
1.5—3.5	50	16
3.5—7.0	15	5
7.0—14.0	4*	2

*Spaced to occupy ¼ inch, all others close-wound.

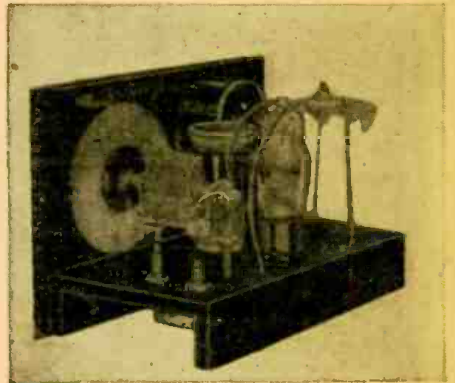

How the instrument looks out of its cabinet.

Before operating the unit, 2 preliminary adjustments are made. The OFF-ON switch S1 is thrown to the ON position and the filament voltage is first adjusted to 2 volts by throwing S2 to the CALIBRATE position (the upper position in the schematic diagram) and adjusting the rheostat R1 so that the pointer of the meter indicates 0.5 ma. The FUNCTION switch is returned to OPERATE. The pointer of the meter will now indicate about 0.05 milliamperes at no signal. The zero-adjusting screw on the face of the meter is adjusted so that the pointer is at the zero mark. Switch S2 is again thrown to CALIBRATE and the reading noted for future reference, preferably by drawing a red line directly on the meter scale. The filament voltage will still be 2 volts, and the meter will indicate zero for conditions of no signal.

With the meter as now adjusted, the meter pointer will rest off-scale when the unit is turned OFF, which feature will serve as a ready check on the condition of the plate and the bias batteries. If after the filament voltage is adjusted to the proper value, the pointer of the meter does not indicate zero at no signal, the plate and bias bat-

(Continued on page 75)

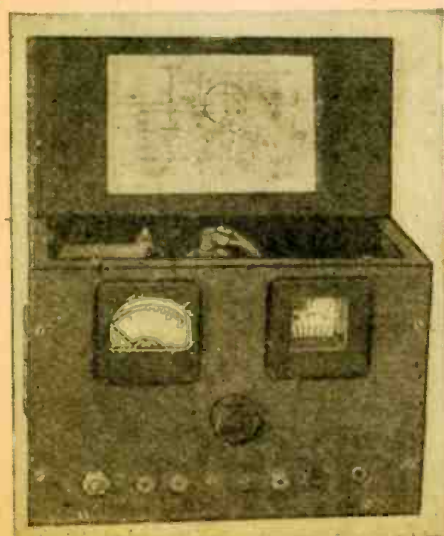

Front view and schematic of the combined vacuum-tube voltmeter and field-strength meter.

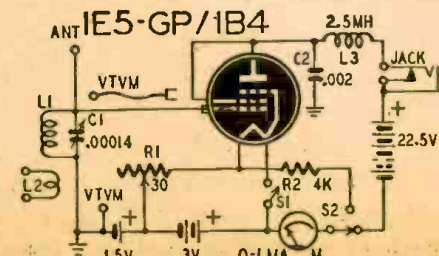

A Useful Tube

Cathode-ray indicator 6AL7-GT can be used in several new ways

By ERIC LESLIE

SERVICEMEN and experimenters will find many uses for the new General Electric FM/AM tuning indicator tube, the 6AL7-GT. This is a cathode-ray tube, with a fluorescent screen at its end on which the pattern appears. This pattern may be made to take various forms in different types of FM and AM receivers and in test instruments. The tube can be useful in any application where it is desired to balance two voltages, or to compare one voltage with a reference voltage. A brief description of the 6AL7-GT was given in the January, 1947, RADIO-CRAFT.

As in other cathode-ray tubes, a cathode emits electrons toward a positively charged target which glows where struck by the electrons. The target is divided into 2 parts, causing the fluorescence to appear as 2 rectangles. Control electrodes vary the size of the rectangles, one electrode usually being maintained at a fixed voltage and the other varied by the voltage to be indicated or studied. A space-charge grid controls the speed of the electrons moving from cathode to anode. By increasing its negative bias with respect to the cathode, the effect of the control electrodes is made greater and the sensitivity of the tube is increased.

Several patterns produced by different circuit combinations are shown in Fig. 1. The simplest indicating circuit for FM receivers is shown in Fig. 2. If desired, the space-charge grid may be returned to cathode rather than ground,

the result being a reduction in deflection sensitivity.

Since the voltage output of a discriminator is zero both when no station is tuned in and when a station is tuned in exactly, the pattern (top of Fig. 1) is the same for off-channel and on-tune. This disadvantage can be eliminated in receivers which have a squelch circuit by connecting the space-charge grid to the squelch voltage source, as shown in Fig. 3. A negative voltage of 6 cuts off all electron flow to the target, and there is no fluorescence in the off-channel position. As a station is tuned in, the pattern follows the sequence of the second row of Fig. 1.

If squelch voltage is not available, the circuit of Fig. 4 may be used. The varying voltage from the limiter causes the off-channel and on-tune patterns to differ as shown in the third row of Fig. 1.

The tube may also be used as an AM tuning indicator. The circuit is then very simple. All deflection electrodes and the space-charge grid are tied together and attached to the a.v.c. voltage source. As the station is tuned in, the 2 fluorescent rectangles become narrower, somewhat in the manner of the shadow tuning indicators which once were popular. The bottom row of Fig. 1 illustrates this. See also Fig. 5.

The 6AL7-GT is a 6.3-volt tube, with a filament current of 0.15 ampere. The target voltage may fall between 220 and 365 volts, 315 being considered typical.

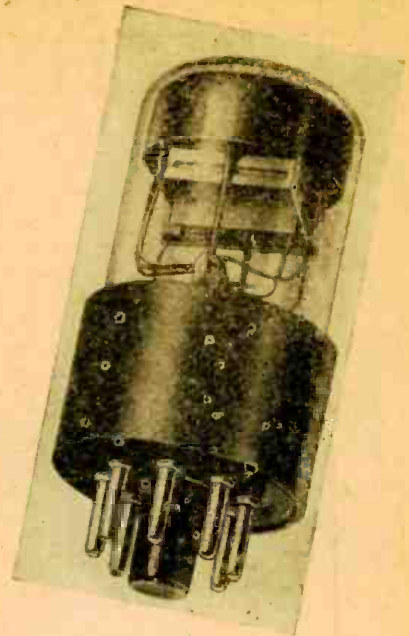

More information on the tube's characteristics is given in G-E's technical data sheet ET-T270A. Further interesting information on the tube and its applications appears in the General Electric *Electronic Tube Engineering Bulletin ET-B14*, which supplied much of the material on which this article is based.

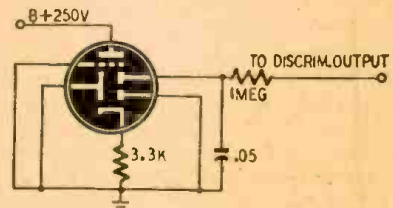

Fig. 2—The simplest hookup for the new tube.

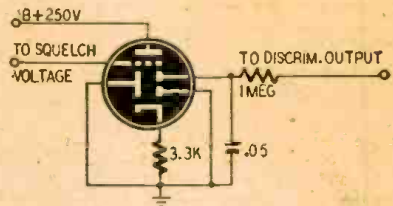

Fig. 3—This circuit has no off-tune pattern.

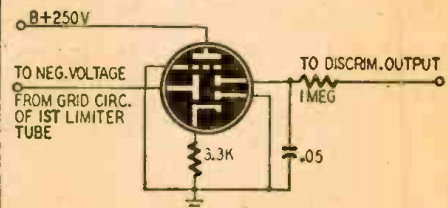

Fig. 4—A circuit for radios without squelch.

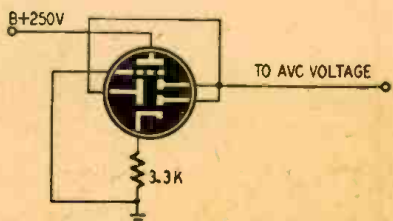
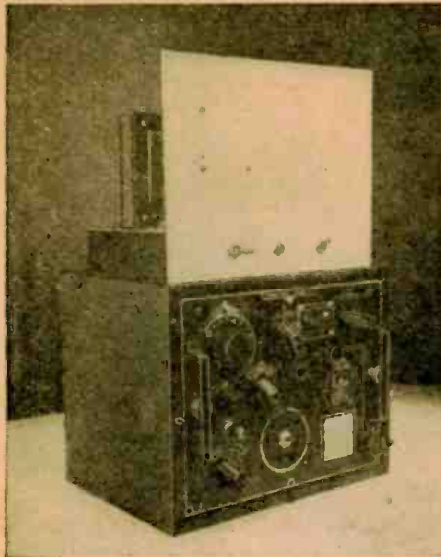

Fig. 5—Hookup for an AM tuning indicator.

CONTROL VOLTAGE SOURCE	SIGNAL	CIRCUIT (SEE FIGURE)	OFF CHANNEL (-)	ON CHANNEL OFF TUNE (-)	ON TUNE	ON CHANNEL OFF TUNE (+)	OFF CHANNEL (+)
DISCRIMINATOR	FM	5 AND 6					
DISCRIMINATOR AND SQUELCH	FM	7					
DISCRIMINATOR AND LIMITER	FM	8					
AVC	AM	9					

Fig. 1—Types of tuning patterns produced by the four circuit arrangements shown at right.

Carrier Radiophone



The power pack sits above the transmitter.

RADIO communication and carrier-current communication are very similar. Both use radio-frequency energy generated by a transmitter, and both use receivers which convert the r.f. signals into sound. The difference between the two is the medium used to link the transmitter with the receiver. Radio communication employs an aerial to radiate r.f. energy through space to the receiving aerial. Carrier-current or wired-wireless communication uses an electric power line or some other metallic circuit to transport the signal from the transmitter to the receiver (s).

Part I — Transmitter section, constructed from a Navy surplus plug-in tuning unit

By **BOB WHITE**

Because of the FCC's ruling limiting the radiation of r.f. energy, it is advisable to use a frequency below 200 kilocycles where radiation is not great. Since most public-utilities carrier-current systems operate below 160 kilocycles, it is therefore necessary to operate on a frequency between 160 and 200 kilocycles.

The distance covered by this system will depend upon your location. In large cities where the line is heavily loaded, you may be able to cover only a few blocks. In rural districts, communication up to many miles may be possible. The distance covered will be dependent largely also upon the time of day because of the changing load on the power line at different hours.

Transmitter construction

The surplus plug-in tuning unit Type CAY-47150, range A, around which this transmitter is built, is one of several coil units numbered A through F which cover frequencies from 350 to 9,050 kilocycles. Each unit contains a master oscillator coil, power amplifier coil, and an antenna tuning coil. These plug-in

tuning units were designed to be plugged into the front of the GP-7 Navy transmitter to operate over a wide range of frequencies. The higher-frequency units have large variable tuning condensers; the low-frequency units, which are suitable for carrier-current service, have no tuning condensers but incorporate a small revolving coil within the main coil to tune the circuit by the variometer principle. The range A variometer tuning unit, which tunes 350 to 800 kilocycles, can be converted easily to tune 160 to 270 kilocycles without altering the coils. The Type CAY-47150, range A, must be used for the carrier-current transmitter. These units are inexpensive, and are obtainable at radio stores carrying war surplus supplies.

After buying the unit, remove the following parts from the larger section which is labeled P.A.: the .00072- μ f, 5,000-volt condenser, the tapped coil L204, the 5-position selector switch S-204, the 5 x 2-inch plate having 2 contacts, and the $\frac{3}{4}$ x 2-inch plate having 1 contact. Nothing need be removed from the smaller section labeled M.O. The various parts in the unit are clearly labeled and can be easily recognized.

Study the wiring of the unit carefully and compare it with the diagram of the transmitter, Fig. 1. Note that the 2 mica condensers C2 and C3 in the M.O. (master oscillator) section, which are connected in series, have to be connected in parallel to lower the tuning range frequency. If desired these 2 condensers can be removed and replaced by a single mica condenser having a capacitance of .0075 μ f. Condenser C7 in the P.A. (power amplifier) section can consist of either an additional .004- μ f, 3,500-volt, mica condenser used in parallel with the .0011- μ f, mica condenser included with the unit or a single .005- μ f, 2,500-volt, mica condenser installed in place of the .0011- μ f condenser included with the unit.

Drill a hole in the partition separating the M.O. section from the P.A. section for the octal socket of the 6L6 tube. Note that the 6L6 oscillator tube must be metal because it is mounted in the P.A. section. Drill 3 additional holes in the partition for the filament wires, B-power wires, and the r.f. wire. Mount rubber grommets in these holes for the wires to pass through. Drill a hole in the back of the case on the M.O. side

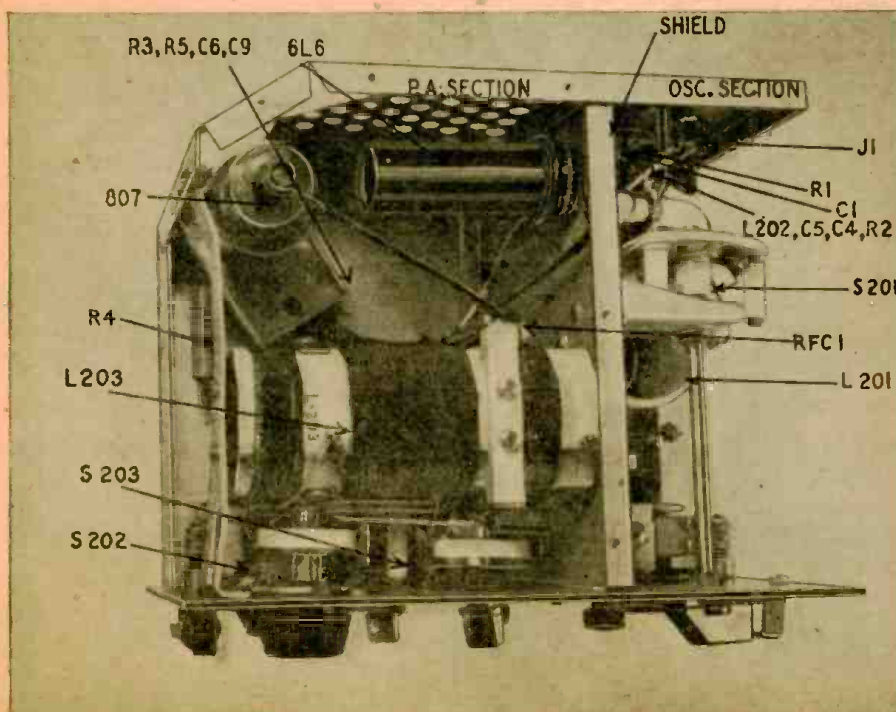

The transmitter, top view. Call-out lettering refers to the schematic on opposite page.

for the jack J1. Enlarge the hole left after the removal of the ANT. TUNING STEP switch S-204 and mount the jeweled pilot lamp bracket in it. Mount jack J2 on the front panel in the hole left by the removal of the ANT. TUNING control and antenna tuning coil L204. Remove the mounting bracket from the switch S-204. This has a hole in it just the right size for the 5-prong socket of the 807 tube. Mount the bracket and 807 tube socket on the diagonal part of the back of the chassis as illustrated in the pictures.

Wiring the transmitter is very simple. The diagram shows the shield separating the M.O. section from the P.A. section and thus differentiates clearly in which section the various parts and wires are located. The coils need not be altered, but the original wiring scheme of the unit must be revised.

The inner chassis has a U-shaped shield which fits over it. Although the unit was designed to be removed from the steel carrying case while in use, the case may be left on if holes are drilled in the back opposite the jack strip. Wires running from the jack strip in the back to the power supply can be soldered to the jacks easily.

An alternate transmitter

Although it is most probable that you will be able to procure a tuning unit, the availability of war surplus items is unpredictable; therefore, it may be advisable to include some suggestions on building without this tuning unit.

The transmitter can be constructed on a small metal chassis measuring approximately 10 x 9 x 2 inches. All parts included with the unit can be purchased with the exception of the oscillator coil L201 and the power amplifier coil L203. These coils will have to be constructed.

Sketches of both coils showing the dimensions and general arrangement of the windings are given. The coils in the tuning unit are wound on ceramic forms. All windings are wound in the same direction with No. 14 cotton-covered enameled wire. The M.O. coil L201 (Fig. 2) has 54 turns on winding A. The top of winding A is connected to position 5 of selector switch S-201, a tap located 7 turns from the top is connected to position 4, a tap at the 18th turn to position 3, a tap at the 27th turn to position 2, and a tap at the 35th turn to position 1. The bottom end of winding A is connected through the front rotating shaft to the revolving coil located inside of the large form. The revolving coil has a single winding divided into 2 sections C and D, 8 turns each. The other end of the rotating coil is brought out through the back shaft and connected to winding B and also to the cathode of the 6L6 tube. Winding B consists of 15 turns; the bottom of this winding is connected through jack J1 to the chassis. The P.A. coil L203, Fig. 3, has 3 fixed windings and two rotating coils. The rotating coils are identical to L201. Winding E consists of 15 turns; one end of this winding is connected to the 807 plate, the other end to the selector arm of P.A. TUNING STEP

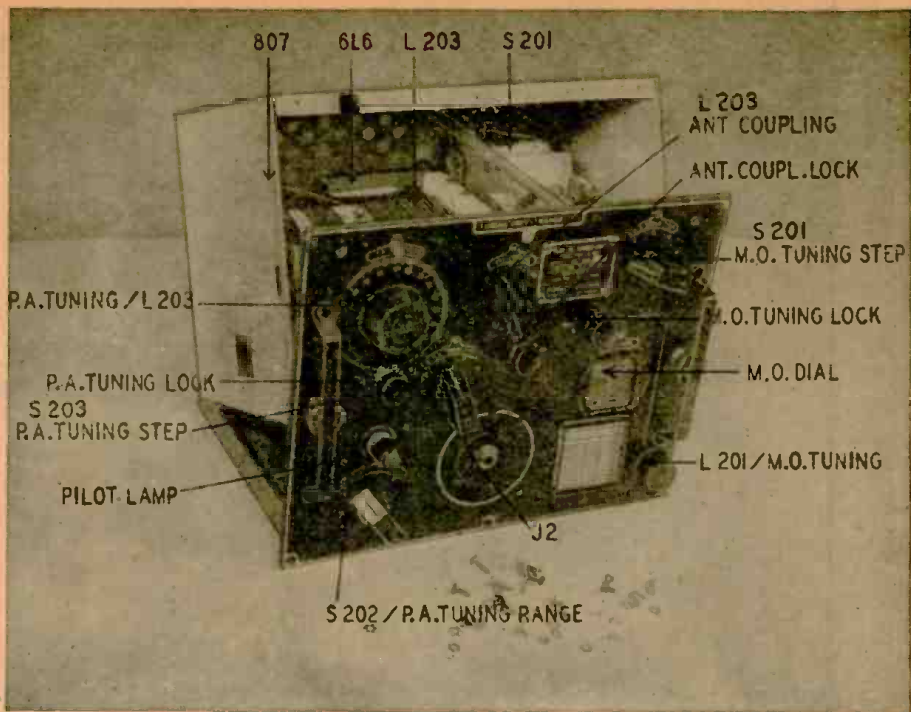

Front view. The unit lends itself well to construction of a carrier-current transmitter.

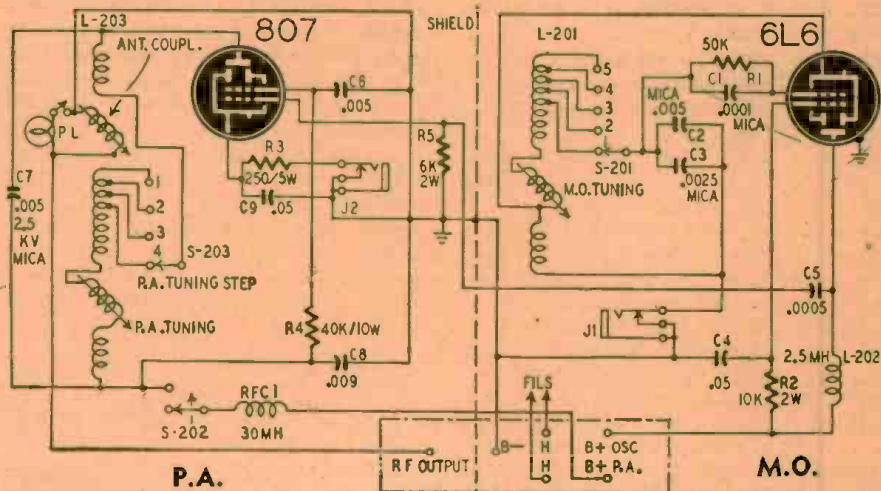

Fig. 1—Schematic of master oscillator and power amplifier. Coils are those shown below.

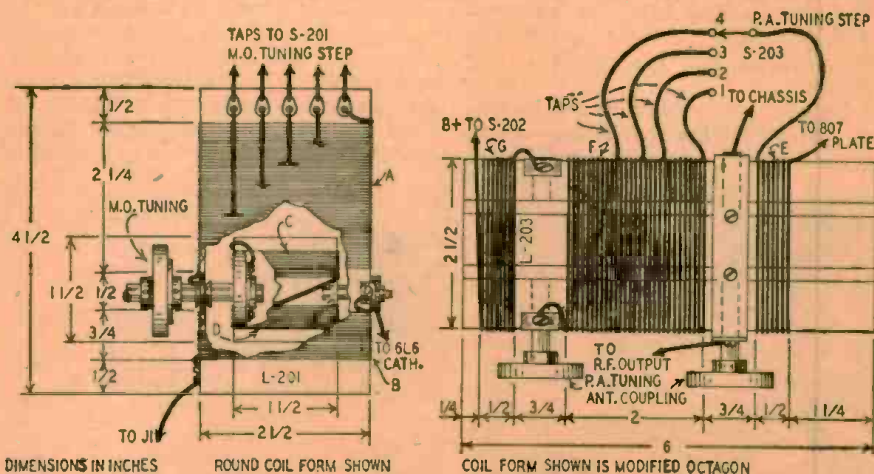

Fig. 2—Coil L-201 in the master oscillator.

Fig. 3—L-203 is the power amplifier coil.

switch S-203. Position 1 of this switch is connected to the beginning of winding F, position 2 to a tap 6 turns, position 3 to a tap at the 20th turn, and position 4 to a tap 30 turns from the be-

ginning. The total number of turns on winding F is 57. The end of winding F is connected through the front shaft to the rotating coil marked P.A. TUNING.

(Continued on page 71)

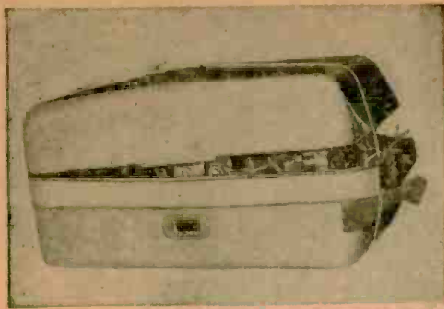

Photos 1 and 2—The cabinet before repair work had been started. Sides were warped and door would not close.



Plastic Cabinet

Straightening

By MAX ALTH

Of all broadcast radio sets, the midget portable gets the most abuse. Not only is it dropped and banged against obstacles as it is carried along, but because of its small size it is stuffed into suitcases along with tennis racquets, shoes, and such. As a result, the set usually suffers as much from cabinet warpage and breakage as it does from circuit break-down.

Photos 1 and 2 show a typical set after some years of faithful service. The front door containing the antenna no longer springs open when it is released because the casement is warped. It has to be pulled open. The leatheroid covering of the door has been gradually torn away. The latch no longer holds the two halves of the cabinet together and has been supplanted by a piece of string. The handle has long since disappeared and has been replaced with a length of garter. The back of the set has developed a hump like that of a camel, and the speaker louvres also have warped out of shape.

The chassis and batteries were removed, the garter cut away, and the unit prepared for the straightening process.

A heat lamp—in this case a G.E. 250-watt infra-red heat reflector—was screwed into a goose-neck lamp holder

and directed onto the portion of the cabinet to be straightened, as shown in Photo 3. We found 6 inches to be about the right distance for the lamp. Bringing the lamp too close will cause little ripples to form on the plastic surface. Keeping it too far away tends to slow the process down interminably and to heat and soften the entire cabinet. Ideally the process should take about 10 minutes.

As a first step, the lamp was directed so that one of the rear sides was heated. It bulged, and then the side was compressed against the table top, beneath a small flat board. The pressure was applied by hand. The lamp was removed, and the plastic gave gradually beneath the pressure. When the plastic cooled, it held its correct shape.

The louvres were first heated in the same manner (Photo 3), then the vertical dips were straightened out with a small piece of wood. Then a block of wood was placed beneath the louvres, on the outside (the side opposite the speaker), and the block of wood and cabinet were placed face down on the table. Blocks of wood were then placed on the other side of the louvres and pressure supplied by an old speaker (Photo 4). Results were fair. Small strips of wood should have been cut to fit the spaces between the louvres so that they

would not warp in one plane while being compressed and straightened in another.

Even support necessary

Which brings up an important point. Be sure that all heated surfaces are supported, otherwise a side or top will collapse when it softens. Don't heat any surface more than necessary, and see that the compression surfaces are smooth, otherwise the plastic will bear its imprint. Also make certain that compression of one warped side does not tend to warp another. That is, don't prop or support one side or surface of the case against another. Do not overstretch or overcompress. Shrinkage on

(Continued on page 58)

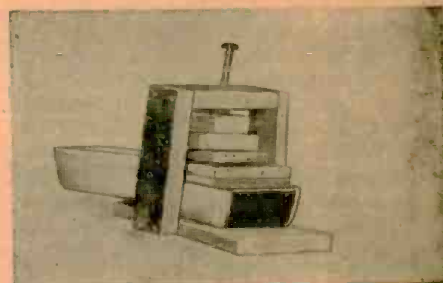

Photo 5—Clamp for straightening the back.

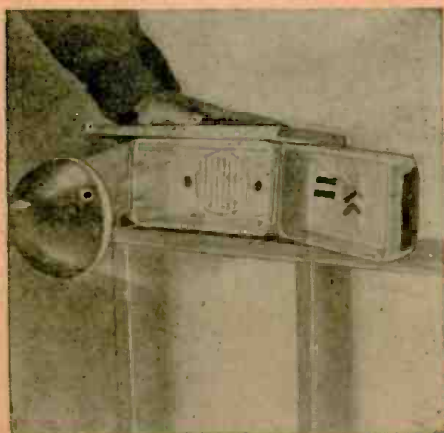

Photo 3—Heat and pressure flatten the back.

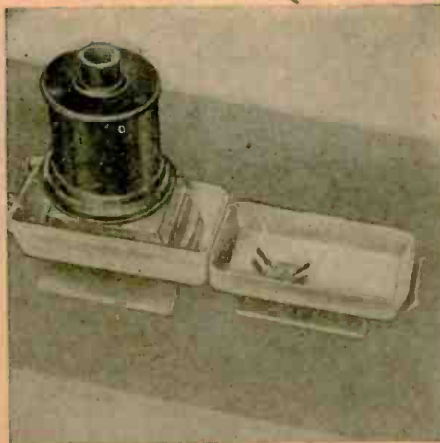
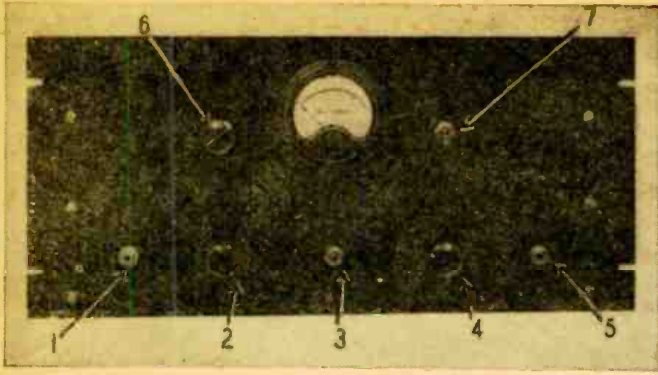

Photo 4—How the louvres were straightened.



Photo 6—The new latch bolts are soldered in.



Above—Front view of the unit. Numbers are explained in the text.
Right—Top view. Some changes were made since the photo was taken.

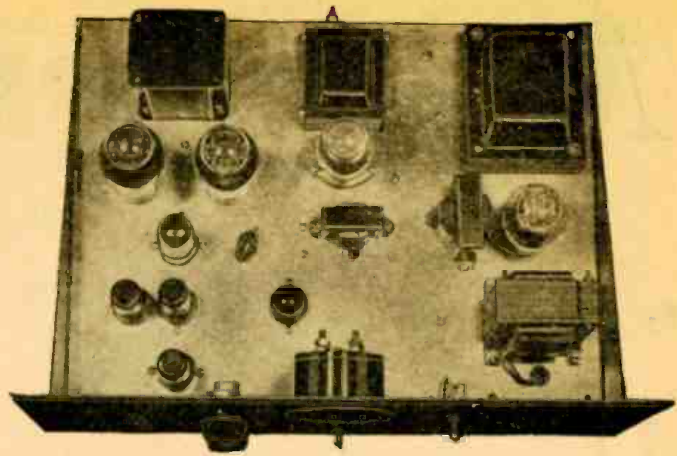

250-Watt FM-AM Transmitter

PART IV—The speech amplifier circuits

By HARRY D. HOOTON, W3KPX

PRECEDING articles in this series described the FM and radio-frequency circuits of the W3KPX FM-AM transmitter. In this installment we shall discuss the design and construction of the AM speech amplifier and the class-B modulator stages.

The audio-frequency response of this speech amplifier is practically flat over and beyond the two extremes of the male and female voice range. Peak compression or so-called "automatic modulation control" is used to raise the average modulation percentage level and signal intelligibility. This feature is particularly desirable when working through heavy interference or on extremely long distance communication. Inverse feedback in the push-pull 6F6G driver stage reduces the plate-to-plate impedance of the pentodes to a value which compares favorably with triodes, and reduces any inherent distortion to

a minimum. The class-B modulator tubes are the time-tested Taylor TZ-40's which simplify bias problems and supply more than sufficient audio power to modulate 100% the 250-watt input to the final r.f. amplifier. The speech amplifier consists of a 6SJ7 pentode microphone input amplifier, a 6SQ7 compression amplifier and rectifier, a 6L7 compressor and audio amplifier, a 6C5 audio amplifier and class-A driver, and a pair of 6F6-G's as drivers for the class-B TZ-40's. As shown in the schematic (Fig. 1), all stages are resistance-capacitance coupled up to the 6C5 grid; transformer coupling is used between the 6C5 plate and the push-pull grids of the two 6F6-G's to simplify phase-inversion problems. The rectifier for the speech amplifier power supply is a 5Z3 with a condenser input filter system.

As the photographs show, the speech

amplifier proper, 2 power supplies, and a percentage modulation indicator are built up on a standard 17 x 13 x 3-inch steel chassis and a 19 x 8 3/4-inch, black ripple-finish steel panel. The controls shown on the bottom front of the panel, left to right, are as follows: 1. microphone jack; 2. speech input "gain" control; 3. control switch for percentage modulation indicator; 4. control knob for percentage modulation indicator; and 5. monitoring jack for headphones. The knob at the upper left 6 is the compression control, and the 0-1 d.c. milliammeter is the percentage modulation indicator. The toggle switch at the upper right (7) controls primary power to the 2 power supply units.

The top view shows the 6SJ7 tube near the front panel; the 6SQ7 is the left one of the 2 tubes shown close together; the tube shown at the right in the group is a 6SB7Y which has been superseded by a 6L7, as shown in the schematic, Fig. 1. The small glass tube is a 6C5-GT; however, it is recommended that a 6C5 metal tube be used in this position instead of the glass type shown. When this speech amplifier was de-

(Continued on page 70)

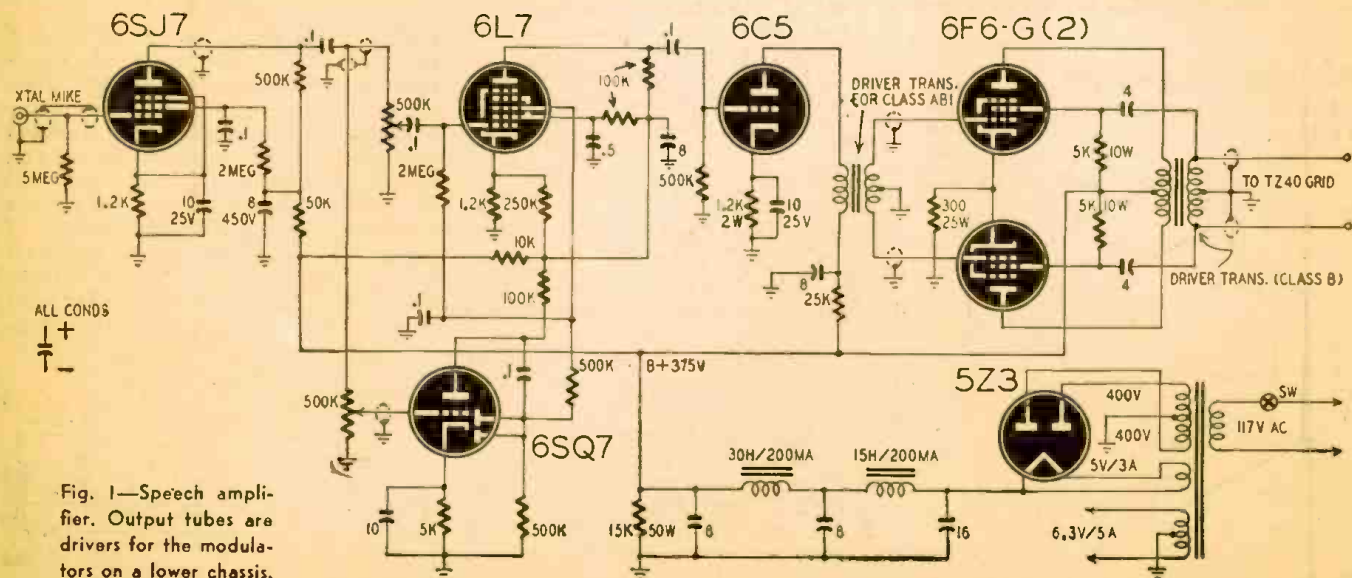

Fig. 1—Speech amplifier. Output tubes are drivers for the modulators on a lower chassis.

Magnetism —

Part I—A modern view of permanent magnet theory

By A. C. SHANEY

THE subject of magnetism is very old (the compass appears to have been invented over 4,000 years ago), yet it remains one of the least understood of phenomena. It was not until the twelfth century A.D. that European scholars tried to fathom its secrets, though the magnet or lodestone had been known to them for centuries, and mention of it is found in legends dating several centuries B.C.

In Europe as in Asia the magnet found its almost exclusive use as a means for determining direction. This unfortunately caused its poles to be given geographical names (north and south). This clumsy terminology has been an obstacle to the student. We will therefore rename the poles arbitrarily, calling the north (N) pole the *positive pole* and the south (S) pole the *negative pole*. To avoid confusion with electrical signs, magnetic pole signs will be circled

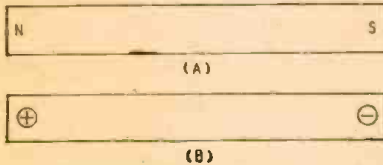

Fig. 1—Illustrating the new magnet markings.

in drawings, as shown in Fig. 1, and put inside parenthesis in text. This is one of a few new concepts we will introduce in an attempt to present magnetic phenomena more clearly to technicians and experimenters who may be interested in contributing to the art of magnetic recording.

New magnetic concepts

Probably nearly every reader (including the author) was first introduced to

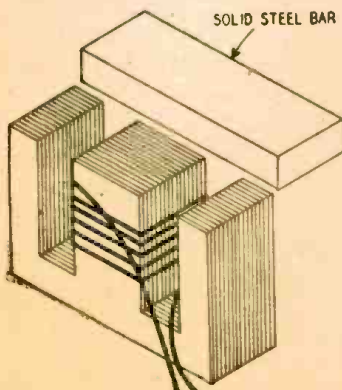

Fig. 2—Simple equipment for magnet studies.

the mysteries of magnetism via the old familiar bar magnet. When, in 1820, Sir Humphry Davy magnetized a bit of soft iron by running a current of electricity around it, he produced the first bar electromagnet. For an unobstructed understanding of magnetic recording it is suggested that the reader temporarily forget Davy's bar magnet and how it was made. To help forget, try this experiment:

1. Disassemble an old transformer made with E-1 laminations.
2. Stack all the E's together.
3. Slip a coil of wire (about 100 turns of No. 20 R.W.G.) over the center leg.
4. Place a steel bar across all 3 legs as in Fig. 2.
5. Apply 6 or more volts d.c. to the coil for a few seconds.
6. Pull the steel bar away from the laminations.
7. Examine the polarity of this bar magnet with a compass and by sprinkling powdered iron on a sheet of paper placed over the magnet.

Your examination will show that you have made a magnet with like poles at both ends! The powdered-iron pattern will look like Fig. 3-b instead of the usual magnetic field pattern of Fig. 3-a.

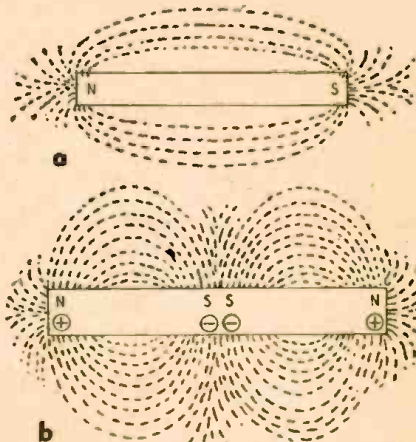

Fig. 3—Two types of permanent magnet fields.

This unusual type of magnet is one of the cornerstones of modern magnetic recording processes.

Two important things should be remembered about this magnet:

1. It was formed *without* passing an electric current around it.
2. Its polarity resembles that of 2 common bar magnets which have been physically joined at like poles.

If this twin magnet be bent into the familiar horseshoe form, it will not exhibit usual magnetic properties at its terminal poles.

This magnetic characteristic resembles the effect produced by connecting 2 similar batteries back to back and

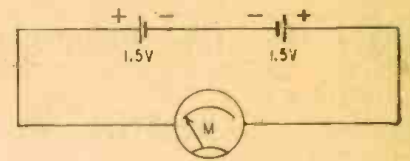

Fig. 4—Electric analog of multipole magnet.

measuring "no voltage" across their outermost terminals (Fig. 4).

If we should pass some current around the flat surfaces of a hard steel disc (Fig. 5-a) about 1 inch in diameter

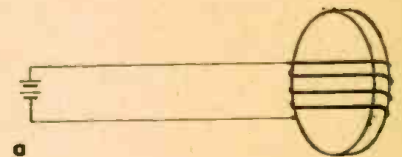
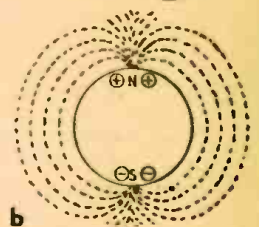

Fig. 5-a—Circuit for making a disc magnet.

5-b—Chart of a disc magnet's force field.



and 1/4 inch thick, we would have a short cylinder magnetized in the direction of its diameter (Fig. 5-b). (You should have forgotten about ordinary bar magnets by now.) If a hole is drilled through its center, a shaft inserted and the wheel rolled on a small hard steel rod or rail (Fig. 6), the rail will become weakly magnetized at the points of polar contact. This passage of magnetic induction from one magnet into a magnetizable substance by contact (or near contact) and the retention of the mag-

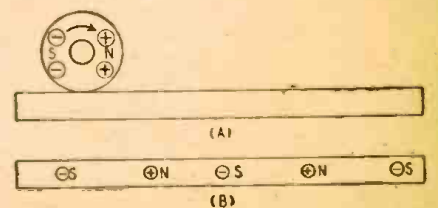

Fig. 6—Magnetization of a strip of steel.

netism by the latter is known as *transference*. Susceptibility to transference determines the degree of interference to be expected when a turn of magnetically recorded wire comes in direct contact with an adjacent wire.

We now have a rail (a magnetic signal carrier) which has been magnetized (modulated by a magneto-mechanical modulator). We can expose or view (detect) these magnetic modulations in a number of ways. A small compass may be used to explore the magnetic field around the rail; or finely powdered iron may be sprinkled on the rail to find its magnetic nodes; an electromagnetic detector (a soft iron horse-shoe-shaped rod which passes through a multiturn coil connected to a sensitive galvanometer and whose ends are separated by a distance equal to half the circumference of the magnetic disc), as illustrated in Fig. 7 may be moved along, and in contact with, the rail; or the rail may be moved against the detector. In any case a voltage will be produced in the coil and indicated by the galvanometer.

This electromagnetic detection process may be reversed by applying a variable voltage to the coil while the

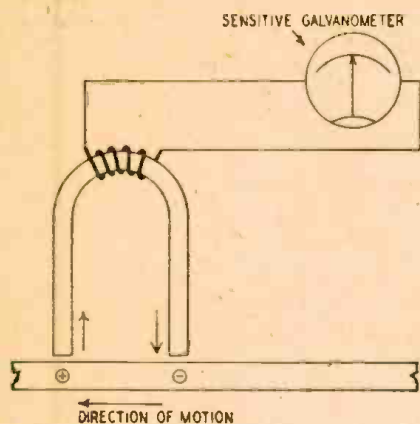

Fig. 7—Simple magnetic modulation detector.

carrier (rail) is moved laterally. The rail will be magnetically modulated as suggested in Fig. 2.

We now have covered the 3 basic elements required to record or transmit intelligence via magnetic media:

1. Magnetic modulator (impresses magnetic modulation on a magnetic carrier);
2. Magnetic carrier (carries the magnetic modulation);
3. Magnetic detector (detects magnetic modulation in the carrier).

As the construction, application, and operation of these basic elements play indispensable roles in the final processes of magnetic recording it becomes important to be able to design these elements for optimum performance. Since they are all primarily magnetic devices, designing them naturally calls for the use of magnetic terms. It is therefore important for a full understanding of the process, to become familiar with applicable magnetic terminology, bearing in mind the very special applications to which it will be applied.

Familiarity with academic magnetic terms may be gained by referring to one

of a number of text books on magnetism. (Also see "Coils, Cores and Magnets" RADIO-CRAFT, October and November, 1946.) For the radio technician and experimenter, it may be easier to understand magnetic phenomena by referring frequently to electrical analogies.

Interpretation of technical descriptions requires an understanding of carefully chosen units and standards to which the names of famous scientists have been applied (for example, fundamental electrical units were named after scientists like Count Alessandro Volta, Georg Simon Ohm, André Marie Ampère, James Watt, and others).

The fundamental units of and formulas relating to magnetic phenomena as developed by physicists are usually expressed in the metric (also called the centimeter-gram-second or c.g.s.) system, which has been internationally employed. Interpretation and application of this information is made difficult for English-speaking students accustomed to the clumsier inch-ounce-second or foot-pound-hour system. Conversion into standard English units are helpful. See Tables I and II.

In magnetics, as in other physical sciences, a fundamental force — Gilbert (after William Gilbert)—is required to produce a quantity—Maxwell (after James Clerk Maxwell)—in a given medium. The ability of the medium to help or hinder the flow of the quantity determines its reluctivity (magnetic resistance) or permeability (magnetic conductance).

When the force Gilbert is simply related to lineal length of the magnetic circuit (1 Gilbert per centimeter), we have a unit of magnetizing force per unit of length called an oersted (after Hans Christian Oersted). Similarly, when the quantity maxwell is simply related to cross-sectional area (1 maxwell per square centimeter), we have a unit of magnetic quantity per unit of area—a gauss (after Karl F. Gauss).

The familiar Ohm's Law of electricity now can be compared with its magnetic equivalent as follows:

$$R = \frac{E}{I} \qquad R = \frac{H}{B}$$

Where
 R = resistance in ohms,
 E = electromotive force in volts,
 I = current in amperes.

Where
 R = reluctivity,
 H = magnetomotive force in oersteds,
 B = magnetic flux in gauss.

Similarly, the conductivity of electrical and magnetic circuits may be approximately compared as follows:

$$G = \frac{E}{I} \qquad M = \frac{B}{H}$$

Where
 G = conductance in mhos,
 E = electromotive force in volts,
 I = current in amperes.

Where
 M = permeability,
 B = magnetomotive force in oersteds,
 H = magnetic flux in gauss.

(Continued on page 79)

TABLE I
 MAGNETIC FLUX DENSITY CONVERSION RELATIONS

	Lines per square in. B''	Kilo-lines per square in. B''	Lines per square centimeter B	Gausses B	Kilo-gausses B
1 line per square inch B''	1	.001	.155	.155	.000155
1 kiloline per square inch B''	1,000	1	155	155	.155
1 line per square centimeter B	6.45	.00645	1	1	.001
1 gauss B	6.45	.00645	1	1	.001
1 kilogauss B	6.450	6.45	1,000	1,000	1

TABLE II
 MAGNETOMOTIVE FORCE CONVERSION RELATIONS

	Ampere turns per inch H''	Ampere turns per centimeter H	Gilberts per centimeter H	Oersteds H
1 ampere turn per inch H''	1	.394	.495	.495
1 ampere turn per centimeter	2.54	1	1.255	1.255
1 gilbert per centimeter H	2.02	.796	1	1
1 oersted H	2.02	.796	1	1



10-Meter Converter Requires No Tuning

By DANIEL SCHULMAN AND NATHAN G. DORFMAN*

FOR the many surplus short-wave receivers now on the market as well as many commercial and home receivers that do not tune down to the 10-meter ham band, a converter is greatly needed. Many types of converters have been designed to extend the frequency range of receivers to this band. Usual practice is to attach to the input an additional unit which includes an additional mixer and oscillator stage and thus convert the receiver to a double superheterodyne. This method necessitates another tuning dial and the attendant difficulty of mounting the converter where it can be reached for tuning.

The converter here described eliminates difficulties caused by an extra tuning dial and calibration of the unit. It is a more easily manipulated device with excellent calibration and extreme ease of construction. There is no tuning of the converter. The receiver is tuned in the normal fashion and the calibration of the band will be as good as that of the receiver being used. It can be readily zero-beat to center frequency by the receiver itself without use of the external frequency meters.

The converter uses a 6SA7 pentagrid tube as a fixed 16-mc oscillator. The

receiver acts as a variable-frequency i.f. and will tune the 10-meter band at beat frequencies in its 12-mc region. Assume a 28-mc signal is being received at the antenna input section of the converter. The local oscillator of the converter combines with this signal and produces 2 beat notes of 12 mc and 44 mc, respectively, which are the arithmetical sum and difference of the original frequencies. The plate circuit is slug-tuned to resonate at 12 mc. The 44-mc signal is therefore attenuated to zero and the 12-mc signal is passed on to the receiver. The receiver being tuned to 12 mc is now receiving the 28-mc signal. The entire ham band extending from 27 to 30 mc can be tuned in by tuning the receiver from 11 to 14 mc.

The limit of the tuning range of the converter is dependent on the band pass of the antenna input section and on that of the plate circuit. These cover between 27 and 30 mc in the antenna section and 11 to 14 mc in the plate or output section. To secure maximum conversion transconductance the plate cir-

cuit is slug-tuned to a broad resonance peak, before coupling to the receiver. Coupling to the receiver is greater than unity to assist band pass and transfer efficiency. The image rejection with a 12-mc i.f. is high in this type of converter, as the images are 24 mc apart. An r.f. stage therefore is not needed. The receiver usually has sufficient gain to compensate for the lack of such a stage in the converter.

Circuit analysis

The antenna circuit (Fig. 1) consisting of T1, C1, and C2 is of high Q and band-spread tuned to cover from

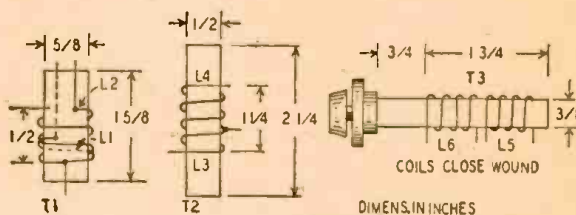

Fig. 2—Dimensions of coil forms. Winding data appears in the text.

27 to 30 mc. L1 consists of 2 turns of No. 25 enameled wire and is wound over the ground side of the grid coil L2, serving as the antenna coil. The bottom side of this antenna coil is shown as
(Continued on page 62)

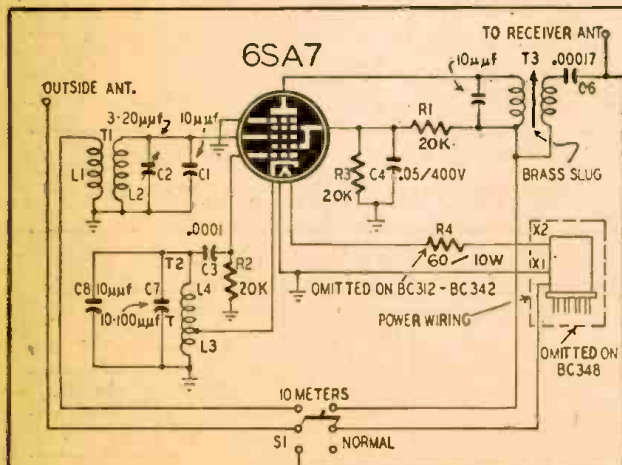
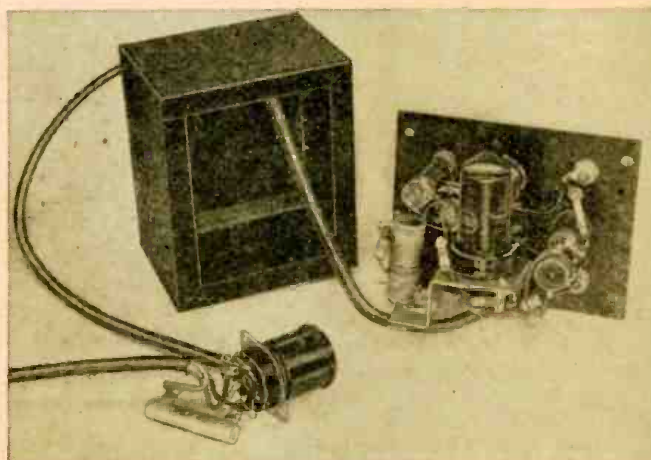

Fig. 1—The 10-meter converter circuit shows some unusual features.



A rear view of the converter. All parts are mounted on the panel.

HOUSEWIVES and TELEVISION

By S. HELLER

"PRACTICALLY anyone can assemble this receiver," states an advertisement in the *New York Times*, offering television kits for sale. "Housewives can build this set. . ."

The copywriter probably has in mind the following cozy scene:

Three ladies are seated before a workbench in a neat basement. They are assembling television receivers with quiet skill. Mrs. David Sarnou is probably the most efficient worker in the group. She wields a soldering iron with each hand, operating with a power factor of 0.95. Occasionally, a slight fatigue causes her to close her eyes, but she continues working just the same. After a while, Mrs. Sarnou looks up.

"Well, girls," she comments with a happy smile, "I've just finished my 7-tube FM section. In fifty minutes more, I should have the 13-tube video circuit completed."

"Good for you," says Mrs. Lee de Woods, who is deftly mounting an i.f. can on the chassis of her set. Mrs. de Woods glances rapidly and expertly at her schematic, which is lying on a chair 15 feet away.

"Do you know, girls," she remarks, "a casual glance at the diagram inclines me to believe that our video amplifiers are not flat beyond 3 megacycles."

"You're wonderful!" says Mrs. Armsweak, wife of Major Armsweak, admiringly. "I could never detect such a flaw if the diagram was more than 10 feet away."

In this way, chatting lightly about video topics, the ladies continue their work; and before the morning is over, they have finished assembling, testing, and adjusting their television receivers. In the afternoon, they attend to their shopping, and, after supper, the three women start work on color television sets, which they complete before bedtime.

That's the way the copywriter visualizes it.

On the other hand, we would like to present *our* version of what may be expected when Mrs. John Q. Public assembles a television receiver.

The scene is the kitchen of Mrs. Susie Hockfleisch. Near Mrs. Hockfleisch are housewives Catherine Tittleberry and

Emily Vanderstupe. They are busily assembling television receivers on the kitchen table.

"Don't you just love these color-coded wires?" says Mrs. Hockfleisch. "I'm going to tie bow-knots in them, to make them look prettier."

"Drat this soldering iron," exclaims Mrs. Vanderstupe. "That's the second time I burned my nose on it." She frowns meditatively. Suddenly a glow lights up her face.

"I've got it, girls, I've got it!" she cries.

The other women look up eagerly. "What is it, Mrs. V.?" asks Mrs. Hockfleisch.

"Why should we solder on these wires,



TRANSVISION
Complete Kit
\$159.50

TELEVISION KIT

Now you, too, can ENJOY TELEVISION, and ENJOY ASSEMBLING YOUR OWN TELEVISION RECEIVER . . . at a total cost of only \$159.50!

It's so EASY with the TRANSVISION TELEVISION KIT, which has been acclaimed by numerous satisfied users. READY FOR EASY, RAPID ASSEMBLY. You don't need any technical knowledge—just a screw driver, pliers, soldering gun—and our easy instruction sheet. Housewives can build this set! COMPLETE WITH SOUND . . . only \$159.50. Yes, only \$159.50—for the parts in this kit, individually priced, would be worth more than \$300.00. Yet the reception delivered by this kit has been rated by ENGINEERS by TELEVISION SPECIALISTS . . . The Transvision Kit and accepted by many major television specialists, and has been checked LARGELY CLEAR, BRIGHT PICTURE . . . Picture size, large enough to accommodate 15 to 25 people. Picture brightness—suitable for viewing in even a lighted room. Picture quality—comparable to a good moving picture. Screen size, 11" x 14 1/2". Remember, you get ALL THE PARTS . . . including a finished frame and specially designed television display, or write to: Transvision, Inc., 1000 Broadway, New York 10, N.Y.

when we can just as easily glue them into place?"

"What a brain," says Mrs. Tittleberry. (Continued on page 71)

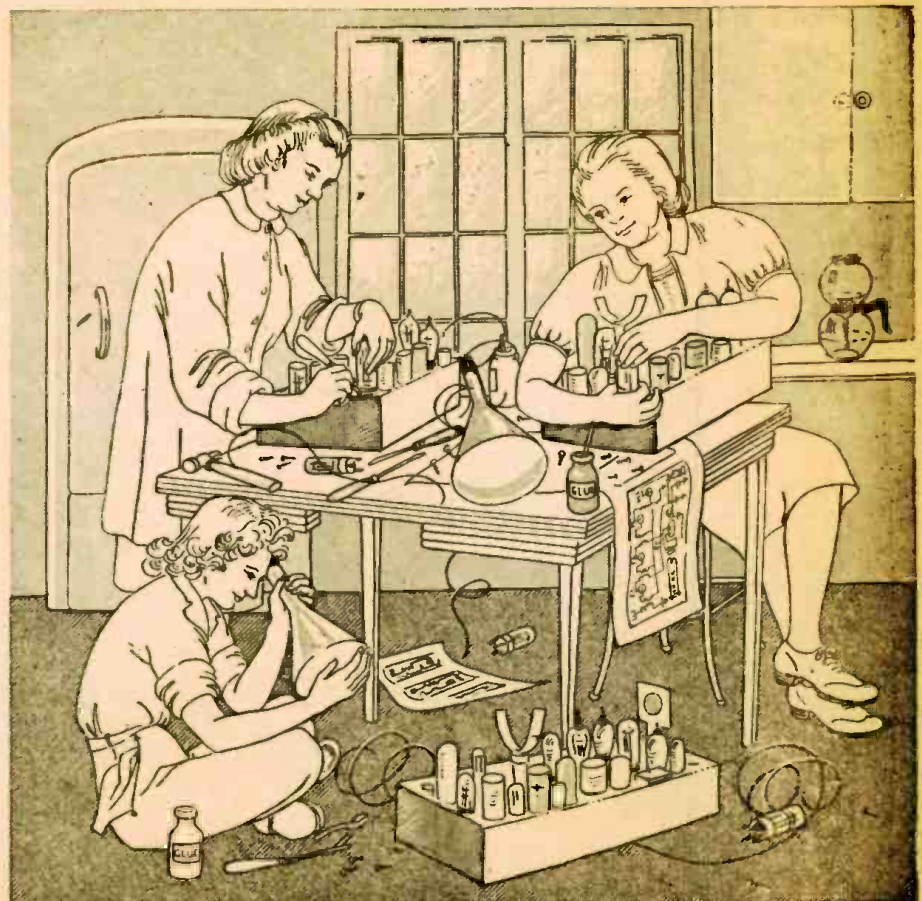

"Vanderstupe's suggestion is immediately carried into action. The irons are discarded . . ."

Radio Set and Service Review

NATIONAL NC-173

New receiver goes down to 5½ meters



THE NC-173 is a new addition to the National line of communications receivers. Its calibrated 6-meter band is a new feature in all-wave receivers and will be welcomed by hams and listeners who have relied on "rush-boxes" and converters for 6-meter reception. An efficient 13-tube super-heterodyne circuit is used with continuous coverage from 0.54 to 31.0 megacycles in 4 tuning ranges. A fifth range covers from 48 to 56 mc, encompassing the 6-meter amateur band (50 to 54 mc). The tuning ranges are:

Band	Range (Mc)
A	50 to 54
B	12 to 31
C	4.3 to 12
D	1.6 to 4.3
E	0.54 to 1.6

The designers have followed the current trends of "dressing up" communications sets so that they present a pleasing appearance in almost any surroundings. The chassis is fully enclosed in a metal cabinet finished in a soft gray with white lettering on all controls. The knobs are gray plastic with chrome trim. The S-meter and tuning dials are white translucent plastic illuminated from the rear. The overall dimensions

are 19½ inches wide by 13 inches deep by 10 inches high. The 6-inch PM speaker is in a matching cabinet.

The main tuning dial has 5 scales, one for each band between 540 kc and 31 mc and a linear logging scale calibrated from 0 to 200.

The band-spread dial has 6 scales. Five are calibrated directly in megacycles for the 5 amateur bands, and the sixth is a logging scale. Band-spread is adequate on all bands. On the band-spread logging scale, 175 divisions cover the 3.5- to 4-mc band, 123 divisions 7 to 7.3 mc, 144 for 14.0 to 14.4 mc, 128 for 27.16 to 29.7 mc, and 77 divisions for 50 to 54 mc.

The tuning controls have 2-inch knobs on flywheel-weighted shafts for easy tuning. Other front-panel controls are: b.f.o. switch, b.f.o. pitch, tone, a.f. gain, antenna trimmer, send-receive, a.v.c. band and switches, r.f. gain, a.n.l., crystal phasing, and crystal selectivity. Jacks are provided for phono input and headphones.

The circuit

The set has a 6S7 r.f. amplifier, 6SA7 first detector, 6J5 local oscillator, two 6SG7 i.f. amplifiers, 6H6 second de-

detector and a.v.c. rectifier, 6AC7 a.v.c. amplifier, 6SJ7 a.f. amplifier, 6V6-GT audio output, OD3/VR-150 voltage regulator, 6H6 a.n.l., 6SJ7 b.f.o., and a 5Y3-GT rectifier.

The input of the receiver is designed for either a single-wire or doublet antenna. Separate primary windings are used on all bands. The band-switch wafers have shorting sections that short and ground all unused coils. No limit stop is used on the switch so it can be rotated through 360 degrees in either direction. The r.f. stage uses a high-frequency, variable-mu pentode. The antenna coils are resistance-capacitance coupled to it through a 0.001-µf coupling condenser and a 100,000-ohm grid resistor. A small variable air trimmer is connected in parallel with the main r.f. tuning condenser to permit the amplifier to be peaked from the front panel. Inductive-capacitive coupling is used between the r.f. and first detector stages on band B, and straight inductive coupling on all other bands.

The local oscillator is a modified tuned-plate Hartley circuit with its grid coupled directly to the No. 1 grid of the 6SA7. Electronically stabilized voltage on the plate reduces frequency drift.

The crystal filter between the first detector and i.f. amplifier has 5 degrees of selectivity varying from broad to very sharp. The first 2 positions are suitable for phone reception and the others for c.w. The phasing control balances out heterodynes and aids in reducing inter-channel interference. The i.f. amplifiers have high-C circuits in the transformers for increased selectivity. Ample gain is provided by the 6SG7's. A part of the signal is taken from the grid of the second i. f. amplifier, amplified by the 6AC7, and rectified by one diode of the 6H6 second detector-a.v.c. rectifier tube. This voltage is used for a.v.c. of the 6SG7 a.f. and i.f. tubes.

The output of the electron-coupled b.f.o. is capacitance-coupled to the second detector plate. The b.f.o. does not interact with the S-meter or a.v.c. This allows some a.v.c. action when receiving c.w. signals.

A 6H6 series noise limiter between the detector diode load and 6SJ7 first audio effectively reduces noise pulses. A variable control is used to adjust the threshold of limiting action.

The 6SJ7 a.f. amplifier is resistance-

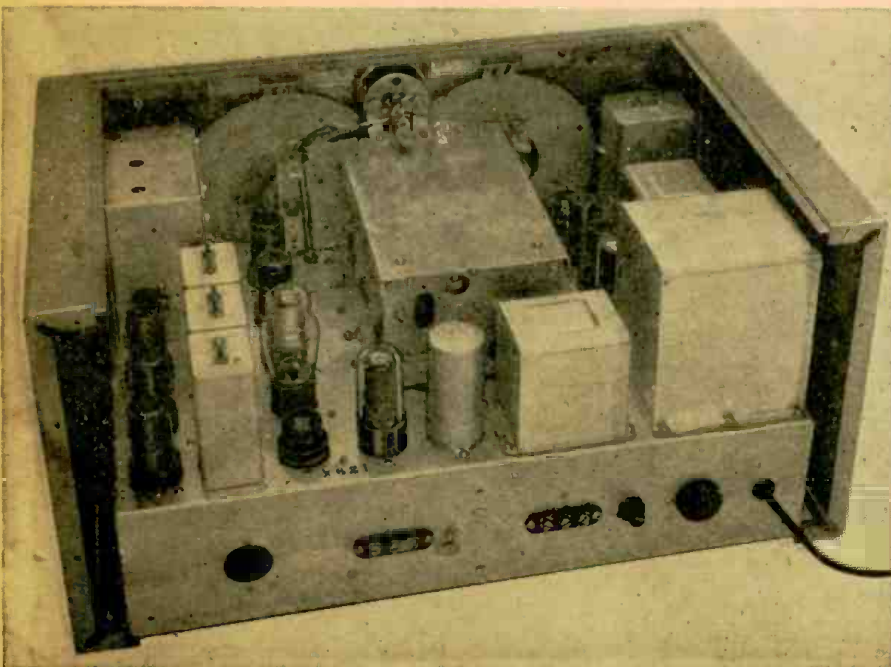

Rear-chassis view. Socket at left is for accessory connections, at right, for battery.

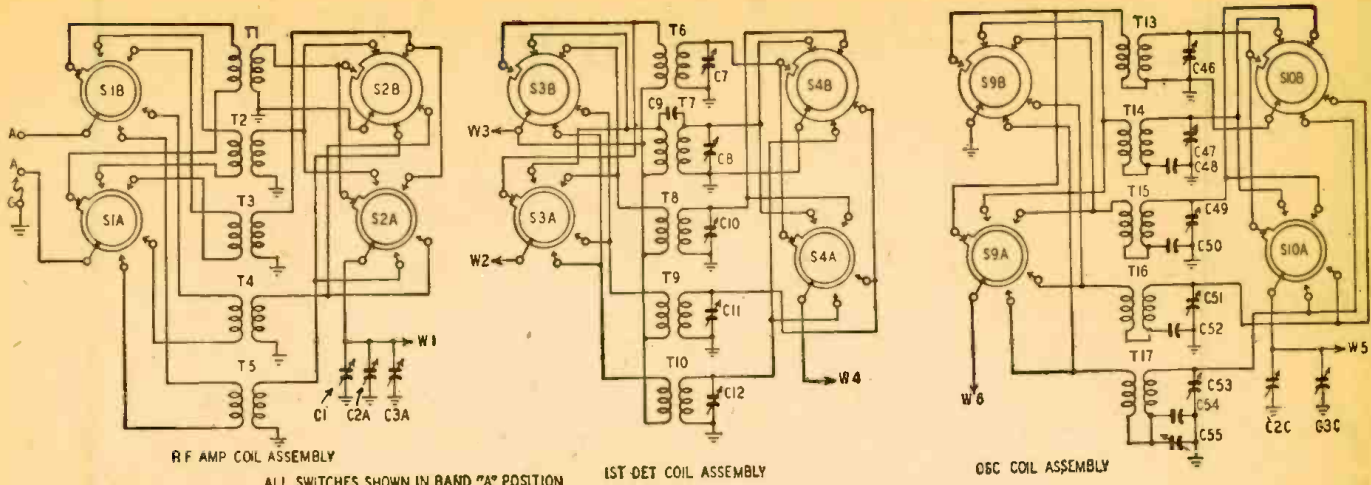

ALL SWITCHES SHOWN IN BAND "A" POSITION
Coil and switch assemblies of NC-173. All terminals are coded to points on schematic below.

coupled to the power amplifier. A resistance-capacitance tone control is connected between the 6SJ7 plate and ground. When a pickup or other a. f. voltage sources is plugged into the phono jack, the a.f. line from the second detector is broken and the external signal coupled to the 6SJ7 grid.

The phone jack is connected across the 8-ohm tap on the output transformer. The speaker is silenced when phones

are plugged in. Higher headphone volume may be obtained by switching the phone jack connections across the 500-ohm tap. These taps are connected to a terminal strip at the rear of the set.

The S-meter is in the a.v.c. diode circuit where its sensitivity is controlled by the setting of the r.f. gain control. The first half of its scale is calibrated in S-units with S9 at midscale. The remainder of the scale is calibrated in

5-db steps to 40 db above S9 at full scale.

The set is wired to operate from 110- to 120-volt, 50- to 60-cycle a.c., but may be used on 220- to 240-volt, 50- to 60-cycle lines by making a few minor changes in the connections to the dual primary of the power transformer. The a.c. line is fused with a 2-ampere fuse in an extractor post on the rear of the

(Continued on page 67)

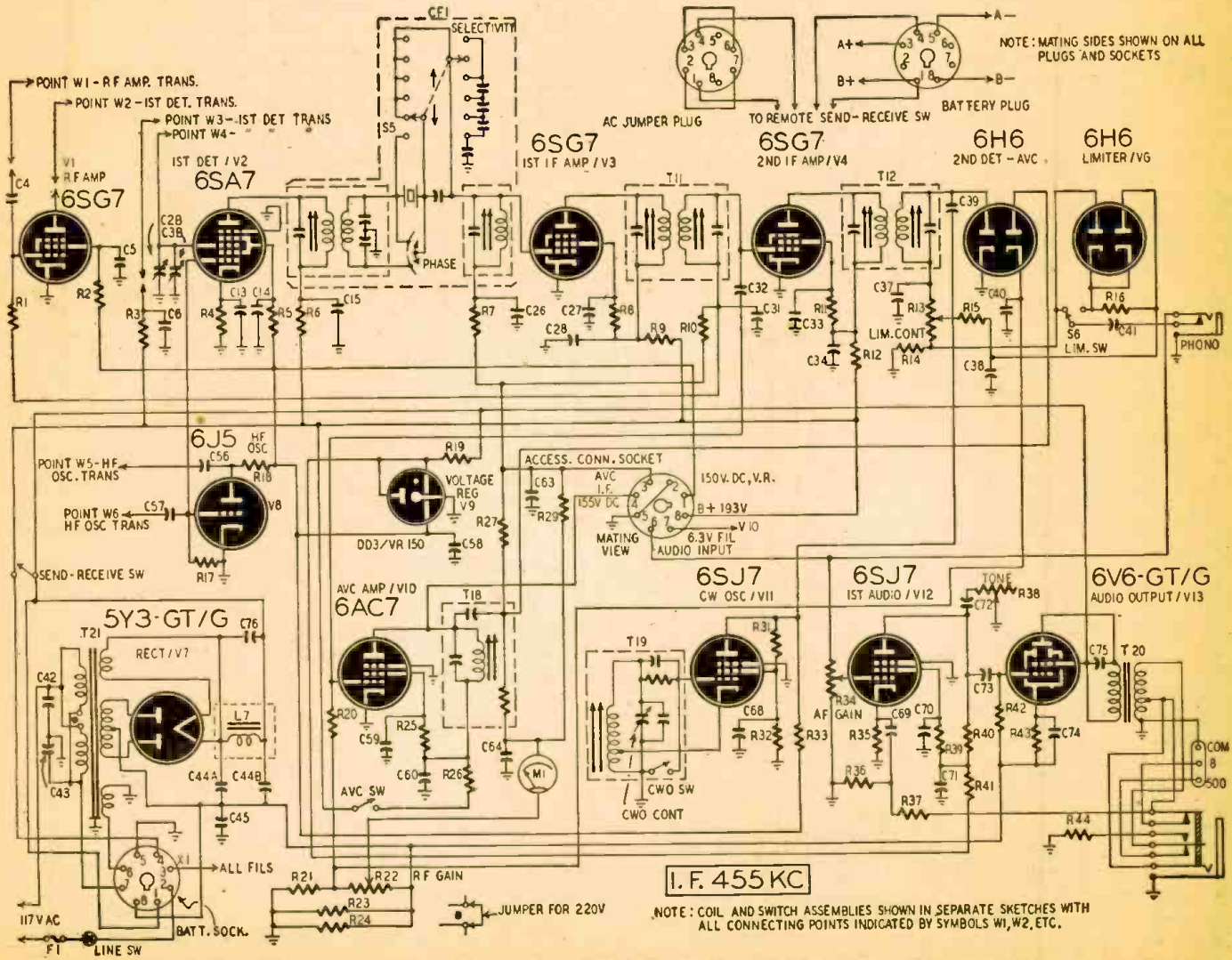

The schematic complete with exception of coil and switch assemblies at top of the page.

Shortwave Rotary Antenna

This 10-meter array has a better radiation angle and front-to-back signal ratio

By CARL V. HAYS, W6RTP

As with most active amateurs having rather limited pocket-books, W6RTP has more or less concentrated on low-power rigs, using any available cash in a search for the most effective antenna system.

The common varieties of 3- and 4-element, 10-meter beams have been con-

structed, with good results. But there has always been that persistent knowledge burrowing around in the back of our mind to tell us that the vertical radiation angle of such arrays is not all it's cracked up to be, at 10 meters, anyway. The logical way to lower this all-important vertical angle of signal path was to vary the height at a particular location until ground reinforcement and other factors all give results as close to the ideal as possible for the frequency, but mechanical considerations limited height to some 25 feet or so.

Daunted but not stumped, we dragged out the *Handbook*, several antenna manuals, and the ever-trustworthy Terman and Henney. After considerable head-scratching over charts and formulas, an array was evolved that appeared to be mechanically practical and in addition, on paper at least, a decided step in the right direction in the elusive search for more and better dx. In the short time this beam has been in use at W6RTP, it

has more than justified our hopes, so hence this article.

The entire array weighs approximately 20 pounds, is very strong, can be rotated very easily and cheaply, and outperforms any other system so far tried.

The array pictured uses ready-made elements of aluminum, made by the

ports by several db, indicating a very definite lowering of the vertical directivity angle toward something approaching the theoretical ideal for 10-meter work. Reception, much to our surprise, was greatly improved, the European and South African stations in particular being much stronger than ever before. China, the Philippines, and others came in several S points better than on any other beam ever tried.

The front-to-back ratio evidently is the same, except on what apparently are high vertical-angle signals, as for a conventional 3-element antenna. These signals seem to be attenuated terrifically when the array is rotated on reception, even the strongest ones dropping to almost inaudible levels when the back of the beam is on them. Some 10- and 40-mile checks on ground wave gave rather startling reports of front-to-back ratio on transmitting. W6DAX gave us a front-to-back report of S9 plus 15 db, and S3½, respectively, a ratio of nearly 4 to 1 or about 48 db! At the same time the side radiation report was S2, certainly not too bad a discrimination pattern for so compact a system, and far and away better than we have been able to achieve with any other beam. An open line that gave indication of some radiating on its own account was used. Possibly even better results could be obtained with a nonradiating feed system, such as co-axial line.

Dx possibilities of systems based on such a design can be judged from the fact that on one occasion, at about noon PST, which is not a good time for Pacific dx, J9KC on Kwajalein was heard calling CQ, at about S6; a quick look over the band showed up one calling him in return, so we fired up the 60-watt rig and gave a shout. Dave came right back with a Q5, S7-8 report, raising it to S9 some minutes later, his signals averaging S6 all this time, running some 600 watts to a BC-610 rig, and using a good antenna system. The comparative reports and powers involved give a fair idea of what low-angle directivity can do. Incidentally, I heard no other W6 contacts made with J9KC until much later in the day, something else to point up the antenna's possibilities, since Dave called CQ W6 several times after our contact, and Kwajalein isn't too common dx to warrant passing up, even by the dx kings. All of our State-side contacts so far have run S9 or better, even hard-to-hook New Hampshire giv-

(Continued on page 69)

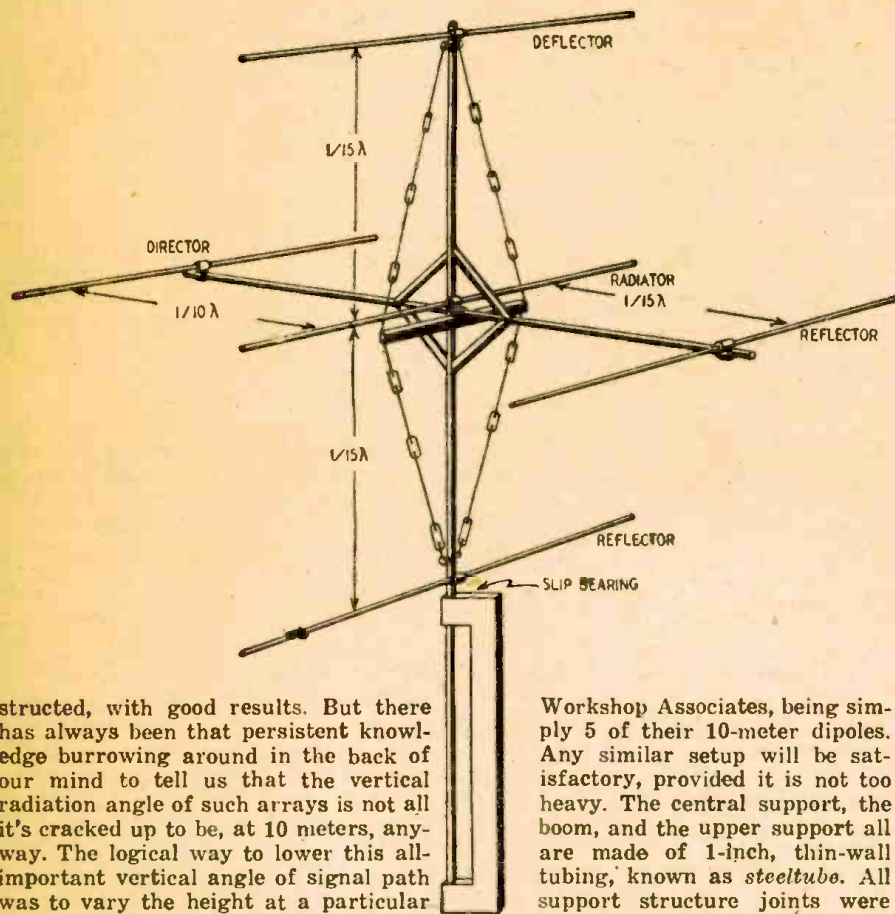

Workshop Associates, being simply 5 of their 10-meter dipoles. Any similar setup will be satisfactory, provided it is not too heavy. The central support, the boom, and the upper support all are made of 1-inch, thin-wall tubing, known as *steeltube*. All support structure joints were brazed securely at a cost of \$2.00.

The array is 15 feet by 8 feet in size, light but surprisingly strong and rigid after the addition of shipmast type trussing, as shown in the illustration. Light turnbuckles in each mast-supporting wire serve to true and-cinch the supporting framework securely.

The array itself is a conventional close-spaced 3-element affair, with an additional reflector directly above and below the antenna proper, spaced 5 feet from the radiator itself. These 2 elements produce a highly improved vertical pattern; their addition to a simple in-line array raised the dx signal re-

"Scotch Receiver" Includes a Lamp

By HOMER L. DAVIDSON

THE "Scotch" receiver is a small a.c.-d.c. broadcast set and also a desk lamp. It is ideal for a young boy's den or as a project for a radio beginner who is interested in constructing small receivers.

A 12SK7 pentode is used as the regenerative detector but a 12SJ7 or any 12-volt triode would do. In the audio section a 12A6 beam-power output tube drives a 4-inch PM speaker. The rectifier is another 12SK7 pentode, although any triode or diode will work nicely if it draws the same filament current (150 milliamperes).

Practically any tube line-up will do if certain things are considered. Be sure the vacuum tubes draw the same heater current. Then add the heater voltages

when using 110 volts as a standard a.c. line voltage.

Regenerative feedback

The receiver covers the entire broadcast band and has sufficient volume for a small room when tuned to a local station. A 365- μ f variable condenser of the midjet variety is used with a regular antenna coil from a broadcast receiver. For the regenerative feedback coil wind approximately 40 turns of No. 36 enamel wire over the grid winding at the ground end. First place a layer of paper over this grid winding and then wind on the ticker. If there is too much regeneration, remove a few turns at a time until the control works smoothly. A 25,000-ohm potentiometer

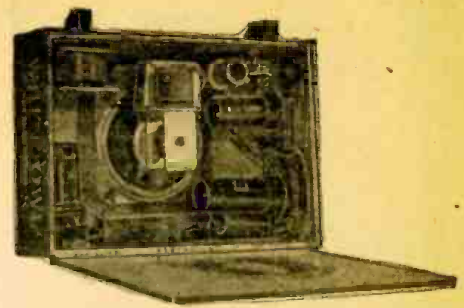

Parts layout can be seen in this photograph. The lamp socket is placed below the speaker.

4-inch PM speaker on local stations. If more volume is desired, another audio stage could be added. When quiet listening is required, a pair of earphones is plugged into a closed-circuit jack. Many broadcast stations will then be heard that are not audible over the small speaker. The jack is mounted in the rear of the receiver, and is in the plate circuit of the 12A6 as shown in Fig. 1.

The rectifier

Another 12SK7 pentode is used as a diode rectifier to change the a.c. from the power line to usable d.c. voltage. All grids of the 12SK7 vacuum tube are wired directly to the plate. The d.c. is filtered with a dual electrolytic condenser and a 3,000-ohm, 1-watt resistor. The original set was built in a period of scarcity; today it would be better to use a regular rectifier, like the 35Z4 or the 35Z5.

All the parts are mounted in a cigar box. A small 2 x 4 1/2-inch metal strip is placed ahead of the variable tuning condenser and regeneration control, eliminating hand capacitance. The major parts are mounted first, then smaller components are mounted and soldered in place. One of the photographs shows the interior mountings and wiring. The other illustrates the stripped-down portion of the lamp, with lamp shade, brass shell, and bulb removed.

The cabinet can be finished with enamel paint or wallpaper finish. The addition of a pair of dial plates would make it a very ornamental set for the shack, den or bedroom.

RADAR FOR RECEIVERS?

A new radio audience measuring device needs only pass the listener's front door to learn whether his radio is turned on, an Oklahoma inventor claims.

The inventor, Hal Phillips of Oklahoma City, is an employee of the local station, KTOK. He says that his instrument need only be installed in a suitable mobile unit and driven down the road. Passing a house, it will tell not only whether the radio is on or not, but to what station it is tuned to at the moment.

The Radio Use Computer, as the inventor calls it, will then record the time and location automatically.

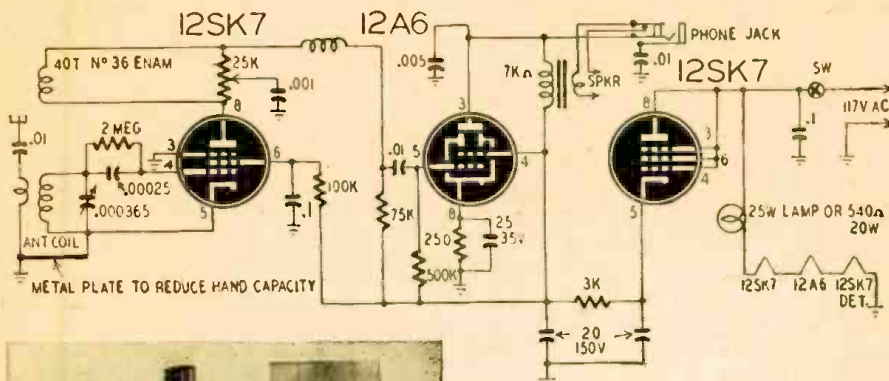

Fig. 1—Note that the 12A6 grid resistor must be grounded, not connected to B-plus.

is used for the regeneration control.

To prevent r.f. from getting into the power supply, an r.f. choke is put in the plate circuit. This r.f. choke consists of 30 turns of No. 36 enameled wire scramble-wound on a 1/4-inch wood dowel.

It is best to use a 75-foot antenna with the "Scotch" receiver. On local stations a 20-foot indoor antenna works out rather nicely, and no external ground is required. For distant stations the headphones are plugged in. During the daytime only stations within 100 miles are available, but at dusk broadcast stations from all over the States break through.

The output circuit

The power tube is a beam-power pentode 12A6. It is sufficient to drive a

together and subtract this total voltage from the a.c. power-line voltage, which in most cases is 110 to 117 a.c. By using Ohm's law formula ($R = E/I$) the dropping-voltage resistance can be determined.

If you want to use the ordinary lamp bulb as the dropping resistance, as in this receiver, here are a few interesting values. A 25-watt bulb has an internal resistance of 480 ohms, a 30-watt-bulb resistance is 400 ohms, a 40-watt-bulb resistance is 300 ohms, a 50-watt-bulb resistance is 240 ohms, and a 60-watt-bulb resistance is 200 ohms. All of the above resistance readings are approximate and are taken

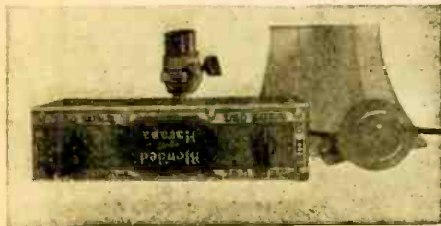

Old Tube Tester Is Still Useful

By HARRY F. LEEPER



Photo 1—Fitting the new pin-jack terminals.



Photo 2—Terminals all in place and labelled.



Photo 3—Some new internal wiring is needed.

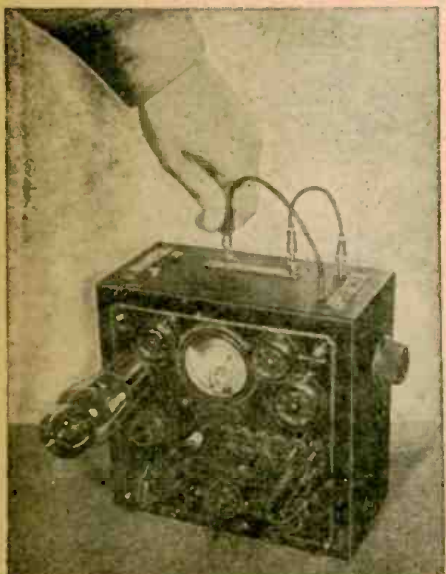

Photo 4—Jumpers restore original circuit.

An outdated tube tester need not be discarded by the serviceman because it will not test all the modern tubes.

A little time spent in rewiring will make it possible to use the meter as a milliammeter, a continuity meter, and an ohmmeter of limited range, plus the original use of testing certain types of tubes.

The accompanying illustrations and diagrams show such rewiring of a typical tube tester.

It will be noted in Fig. 1 that the leads of the milliammeter were broken or opened and the wires from the meter were brought out direct to the terminals marked 1 and 2 on Fig. 2. The original wires to the tube testing equipment were connected to terminals 3 and 4.

Photo 1 shows the tester case and pin jack terminals for these wires as well as two additional pin jacks marked 5 and 6 for use with the ohmmeter.

Photo 2 shows these terminal jacks in place, labeled with stamped metal tape.

The internal connections made to these terminals and the batteries and resistors for the ohmmeter circuit are shown in Photo 3.

To test tubes it is necessary only to connect two jumper leads from terminals 1 and 2 to terminals 3 and 4. See photo 4. To use the milliammeter only, test leads are plugged into terminals 1 and 2.

In arranging the ohmmeter circuit it was necessary to calculate the resistances required. The meter used on this particular tester registers 5 milliamperes full scale, and two 1.5-volt flashlight batteries were connected in series to give 3 volts.

Using Ohm's Law, ($R = E/I$) $3v/0.005 \text{ amp} = 600 \text{ ohms}$.

Since less resistance would be needed when the battery voltage drops off, a 400-ohm fixed resistor was used in series with a variable resistor (an old volume control) which could be varied from zero to 250 ohms.

The circuit inside the case was arranged as shown in Fig. 2.

To adjust the zero setting, leads were connected as in Photo 5. Terminal 1 is connected to terminal 5 and test prods to 2 and 6. Prods are shorted and the control varied until the meter reads full scale or 5 milliamperes.

A cardboard scale was made and

pasted on top of the case as may be seen in this photo and Photo 6.

From the above we found it required 600 ohms resistance to allow 5 milliamperes to flow in the circuit. Suppose the meter with an unknown resistance under test reads 4 milliamperes. (The meter illustrated is graduated in milliamperes from 1 to 5. On other meters it may be necessary to calibrate and mark the dial face.)

(Continued on page 56)

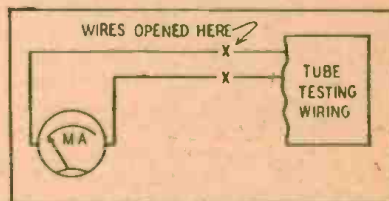

Fig. 1—Fundamental step in rewiring tester.

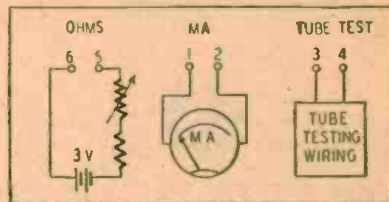

Fig. 2—Terminals for an ohmmeter are added.

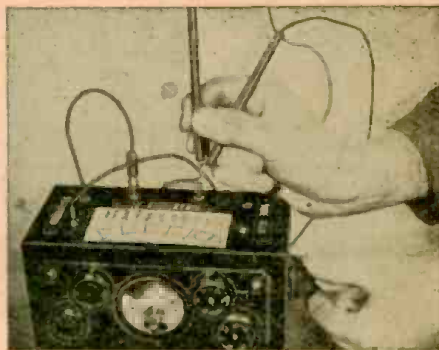

Photo 5—How the ohmmeter circuit is zeroed.

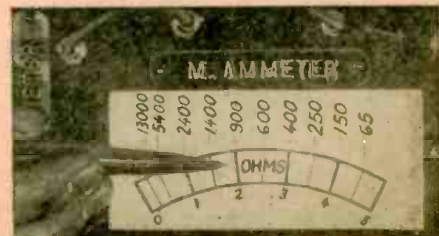
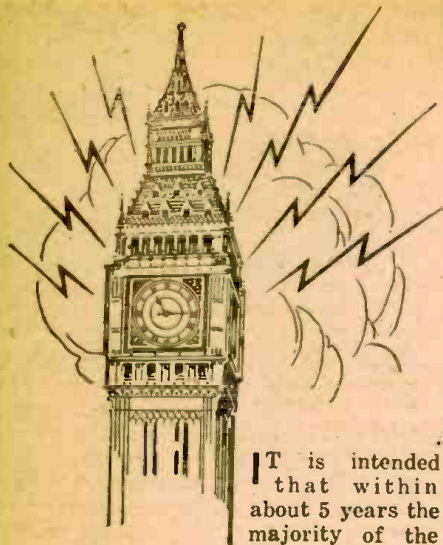

Photo 6—Ohmmeter chart resembles a scale.

Transatlantic News

By Major Ralph W. Hallows

RADIO-CRAFT EUROPEAN CORRESPONDENT



It is intended that within about 5 years the majority of the inhabitants of

Great Britain shall have television broadcasting services available in their homes. This will be accomplished in the first instance by providing chains of transmitters linked by relays to the London station. The problem of installing a nation-wide television service presents fewer difficulties here than in the United States. First, this country is far smaller, stretching only some 600 miles from north to south, and having nowhere a greater east to west extent than about 300 miles. Second, the overwhelming majority of our people live within easy v.h.f. range—say 35 miles—of a comparatively small number of big towns. About one-third the population have their homes within 35 miles of London and thus are already within range of existing installations. Install similar transmitters in or near a further score of the big towns and not less than 90% of our population can be served.

Work is now going forward on the first two of the provincial transmitting plants, one of which will be erected in the Birmingham area and the other probably near Manchester.

These transmitters are considerably more powerful than the one now in use at the Alexandra Palace near London. Their output will probably be between 30 and 40 kilowatts, and they are expected to have reliable service areas with an average radius of 45 miles. One special feature of them is the larger band width for which they are designed. London now radiates modulation frequencies up to 2.7 mc; the new transmitters, capable of dealing with frequencies of 3.5 mc or more, are likely to provide the clearest images yet attained in television. One can foresee some headaches for the designers of television receivers in the future; to produce in a moderately priced receiver r.f. and i.f. circuits with a response curve 5.4 mc wide is already no mean task and to do justice to the new transmissions this will have to be increased to 7-8 mc.

An interesting test was made recently of receiving and retransmitting apparatus designed to act as the radio link for relaying television transmissions. The distance covered was actually 73 miles. The transmission originated at Ascot race course, 21 miles southwest of London, whence it was sent to the Alexandra Palace by BBC's O.B. (outside broadcast) trucks. From the Alexandra Palace it was broadcast in the ordinary way, being picked up at Chelmsford, 28 miles to the northeast, and then being relayed by a Marconi link transmitter to Colchester, a further 24 miles to the northeast. The images as finally received were extraordinarily good and appeared to have suffered scarcely at all, despite the number of radio circuits by which they had been handled on their journey. The most stringent of all tests is to be made shortly. Transmissions that have reached Colchester will be relayed back again to Chelmsford, where they will be displayed on a television screen placed beside one on which the same picture received direct from London will be seen.

The Marconi relay link transmitters contain many novel and interesting features. For vision a carrier power of 5 watts and a carrier frequency of 510 mc are used. Frequency modulation is employed because through the use of limiters a constant output level is obtainable at the receiver end. The vision transmitter antenna is of the horn type, mounted on a 40-foot mast. The sound

channel is also frequency-modulated, and the carrier power is only 100 milliwatts. The sound transmitting antenna is a modified Yagi, with a reflector which is a section of a cylinder, and 8 directors. At the receiving end, a paraboloid serves as antenna for both sound and vision channels. A small rectangular case placed at its focal point contains a stub which enables the impedance of the paraboloid to be matched with that of a co-axial transmission line leading to the receiver.

New television antenna

Speaking of v.h.f. receiving antennas brings to mind a useful type recently brought out by one of our manufacturers who specializes in the field. Two of its most valuable features are that reception is independent of the angle of polarization of the incoming signal wave and that it is directional, having sharp minima at right angles to its plane. This antenna takes the form of a half-wave dipole with its arms bent downward at an angle of 45 degrees from the horizontal, so that it is shaped like a wide inverted V. It was designed originally as an indoor antenna for television reception, being so shaped that it could be fitted up in an attic close under the roof. Used in that way it gives excellent results in localities where signal strength is good. It is not in some ways so efficient a collector as the normal half-wave dipole. Our television transmissions are vertically polarized and if the signal arrives with vertical polarization, the inverted V an-

(Continued on page 76)

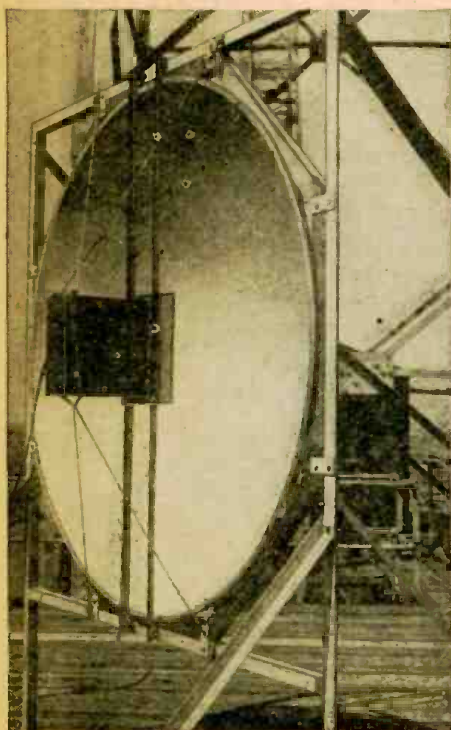

Courtesy Marconi's Wireless Telegraph Co.

The BBC experimental sound-vision antenna.



Fox Photos

Horn antennas transmit the vision signals.



Courtesy of Science Illustrated

Captain Bjorn Arnold Rorholt,
c/o Norwegian Embassy
Washington, D. C.

Los Angeles, Calif.

Dear OM,

I have the answers to the questions regarding the radio equipment on the Kon-Tiki; I will first put the question as sent to them and then their reply.

- 1 - Q, Have you tried generator GN58 for receiver?
A, No.
- 2 - Q, How many batteries did you take?
A, All 41 six volts and 30 forty-five volts.
- 3 - Q, Is there any difference in output between generator and battery operation?
A, Not tried yet.
- 4 - Q, Are you using 6995 KC crystal from the ten meter rig?
A, Yes, but ten meter rig in use too.
- 5 - Q, Have you removed last audio valve in 173 Receiver?
A, Tried, but receiver then too weak.
- 6 - Q, What kind of antenna do you normally use?
A, L antenna
- 7 - Q, Have you tried balloon or kite supported antennas?
A, Both tried.
- 8 - Q, Have you tried voice modulation since shortly after leaving Peru?
A, Yes, results not good.
- 9 - Q, Do you use mark two transmitter?
A, Yes, and then very good.
- 10 - Q, How does the NC-173 stand up under conditions on board?
A, Excellent.
- 11 - Q, How many hours can you operate the transmitter on one set of batteries?
A, High tension batteries very long life but long articles kill our heater batteries.

In case you did not hear me yesterday their heater batteries are used but Raaby tells me that they make 1½ volt units from their 45 volt batteries and then use four of these for six volts and thus get about four days service from each set. They have about five sets left so are O.K. for sometime yet.

"Pen" sends his vy 73 to you as do I and I hope to work you again soon. I am anxious to meet the boys but I am also going to miss these daily contacts with the raft.

I hope Knut, and Torstein keep up their radio and get on the air when they get back to Norway for I would enjoy very much keeping up our friendship via amateur radio.

Again VY73 to you Pronto and hope to cul.

Very Sincerely,

HAL-W6EVM

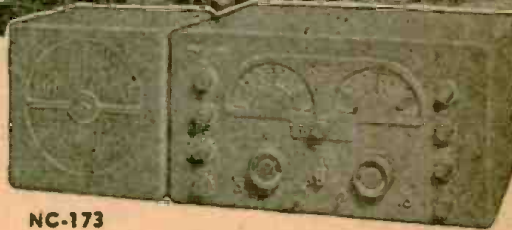

NC-173

Frequency coverage from 540 KC to 31 mc plus the 48-56 mc range. Calibrated amateur band spread on 6, 10-11, 20, 40 and 80 meter bands.

Amateur Net...NC-173 (with speaker) \$189.50

National
EST. 1914

The press of the entire country has carried stories concerning the day-to-day activities of the 6 young Norwegian scientists, members of the Kon-Tiki Expedition, who set out on a raft to drift more than 5000 miles across the Pacific Ocean.

Very little mention has been made, however, of the battery-powered transmitter and model NC-173 receiver which allowed the Expedition to dispatch over 500 messages and 30,000 words.

These figures furnish one more proof that a National receiver in the hands of a good operator makes an unbeatable combination.

**National
Company, Inc.**

Dept. No. 75

Malden, Mass.

U. S. A.

MAKERS OF LIFETIME RADIO EQUIPMENT

WORLD-WIDE STATION LIST

Edited by ELMER R. FULLER

SEVERAL times a month readers ask us how to send reception reports to shortwave broadcast stations, and more particularly, how to get verifications back from them!

Here is the dope as we have it. Most stations will answer SWL reports with a verification card or letter; a few will not, particularly the Mexican and Russian stations. I have heard that the Mexicans reply once in a while but they are not to be relied upon. The BBC is very good about verifications. Reports should include the time and program heard, information as to readability and volume, frequency and anything else that will make the report worth while to them. They use these reports in determining the time and frequencies to use in their transmissions. Reports on the BBC should be sent to the British Broadcasting Corporation, 630 Fifth Avenue, New York City 20. Reports on the Australian stations may be sent to the Australian News & Information Bureau, at the same address.

Other station reports may be sent directly to the station, and should include an international reply coupon for return postage. These coupons may be purchased from your postmaster for 9 cents each. Please remember one thing,

that they should be inclosed with your report and *not pasted or cemented to it*. I hope that this information may help you to better results from your station reports.

Charlie Sutton in Toledo, Ohio, sends us a card to say that reception called dx out his way just isn't during the past summer months, but he expects better results this fall as he will have a new receiver, Hammarlund HQ129X; and he has an RME DB20 preselector to use with it, so we should have some fine reports from Toledo before long now. Stathis Linardos of New York City reports that COBZ on 9.03 mc is on the air from 0800 to 2400 daily, and Ankara, Turkey, (TAP), is on 9.15 mc from 1300 to 1400. XGOY in Chungking, China, transmits from 0945 to 1145 on 9.64 mc. VLG in Melbourne is heard on 9.58 mc from 1300 to 1500. Opal Watkins of Ellijay, Ga., reports several hams, among them OX3GG working a W9 and calling CQ; ZL1CD working with W6ELW; KG6SA working W6RED; F3WT calling W1ENU; VO6R working W2SLV, and F8NP working HH5PA, all on 20-meter phone.

Richard Adams, VE6DA of Duchess, Alberta, reports the Swiss being heard

from 2030 to 2230 on 9.535 mc, 1730 to 2230 on 11.865, and from 2030 to 2230 on 15.315 mc. Adams uses a six-tube Victor receiver. He also reports hearing Pitcairn Island which comes in at present with fair volume even on the east coast. The call is VR6RR, and if a proper and useful report is made, I think you will be rewarded with a verification from this catch. This is the greatest dx obtainable here on the east coast.

For those of you who are new in this game, HCJB in Quito, Ecuador, is always a safe bet for receiving, and may be heard any evening. They will verify when a good report is sent to them, and it will be worth your time to listen for them. They are heard on 9.96 mc from 0545 to 0845 and 1200 to 2230; 12.45 mc from 0600 to 1000 and 1400 to 2330, and on 15.11 mc from 0500 to 1200, and 1330 to 2230. Reports are greatly appreciated.

VLA7 directed to the American east coast is now being heard from Australia on 17.8 mc from 2000 to 2115.

And so until next month best of luck, and plenty of fine business dx. Correspondence may be sent to me in care of RADIO-CRAFT, 25 West Broadway, New York City 7.

All Times are Eastern Standard.

Freq.	Station	Location and Schedule	Freq.	Station	Location and Schedule	Freq.	Station	Location and Schedule
11.70	CKRX	WINNIPEG, CANADA: 1000 to 2000	11.900	CXA10	MONTEVIDEO, URUGUAY: 1830 to 2115	12.090	GRF	LONDON, ENGLAND: 2300 to 1615; 1730 to 2030
11.720	OTC	LEOPOLDVILLE, BELGIAN CONGO: 0530 to 0730	11.930	GVX	LONDON, ENGLAND: 0515 to 0530; 0600 to 0630; 0700 to 0730; 0745 to 0900	12.210	WXFD	VIENNA, AUSTRIA: 1145 to 2030
11.730	WRUL	BOSTON, MASSACHUSETTS: Caribbean beam, 1715 to 1745; 1830 to 0100	11.960	HEK4	BERNE, SWITZERLAND: 1645 to 1715 except Saturdays	12.250	ADAK	ADAK, ALASKA: 1800 to 0100
11.730	KGEX	SAN FRANCISCO, CALIFORNIA: Philippine beam, 0400 to 1100	11.970	FZI	BRAZZAVILLE, FRENCH EQUATORIAL AFRICA: 0000 to 0230; 0445 to 0800; 0930 to 1030; 1100 to 2020	12.260	TFJ	REKJAVIK, ICELAND: Sundays, 0900 to 0930
11.740	COCY	HAVANA, CUBA: 0630 to 0100	11.990	CSX	LISBON, PORTUGAL: 0800 to 1000	12.440	HCJB	QUITO, ECUADOR: 0600 to 1000; 1400 to 2330; Sundays, 0700 to 1630; 1700 to 2200
11.740	CEI174	SANTIAGO, CHILE: 1700 to 2400	12.000	CEI180	SANTIAGO, CHILE: 0600 to 0800; 1600 to 2300	13.050	WNRI	NEW YORK CITY: European beam, 0600 to 1800
11.740	HVJ	VATICAN CITY: 0015 to 0025; 0930 to 0900; 1100 to 1145	12.080		MOSCOW, U.S.S.R.: 0800 to 1100	13.050	KCBR	SAN FRANCISCO, CALIFORNIA: Oriental beam, 2215 to 0100
11.750	GSD	LONDON, ENGLAND: 1215 to 1600; 1715 to 1200				14.560	WNRX	NEW YORK CITY: European beam, 0600 to 1800
11.770	KCBR	DELANO, CALIFORNIA: South American beam, 1600 to 2200				15.000	WWV	WASHINGTON, D.C.: U.S. Bureau of Standards; frequency, time, and musical pitch; broadcasts continuously day and night
11.770	VLA4	MELBOURNE, AUSTRALIA: 1100 to 1200; 1530 to 1830; 2345 to 0045				15.110	GWG	LONDON, ENGLAND: 0000 to 0400; 0600 to 1015; 1100 to 1315; 1500 to 1600
11.780	HP5G	PANAMA CITY, PANAMA: 0745 to 1000; 1200 to 2230				15.110	HCJB	QUITO, ECUADOR: 0500 to 1200; 1330 to 2230
11.780		MOSCOW, U.S.S.R.: 0900 to 1000; 2000 to 2130; 2200 to 0100				15.120	HVJ	VATICAN CITY: 0830 to 0930; 1100 to 1145
11.790	WLW0	CINCINNATI, OHIO: South American beam, 1700 to 2100; 2115 to 2215				15.130	WLWRI	CINCINNATI, OHIO: European beam, 0645 to 1500; North African beam, 1515 to 1630
11.790	KNBX	DIXON, CALIFORNIA: Chinese beam, 0400 to 1100				15.130	KGEI	SAN FRANCISCO, CALIFORNIA: Alaskan-Chinese beam, 1700 to 1945
11.180	KCBF	DELANO, CALIFORNIA: Alaskan beam, 2400 to 0315				15.130	KGEI	SAN FRANCISCO, CALIFORNIA: Southwest Pacific beam, 0115 to 0845
11.810	WOOW	NEW YORK CITY: European beam, 0500 to 0715				15.140	GSF	LONDON, ENGLAND: 2300 to 0400; 0600 to 0815; 0830 to 1745
11.810	WGEA	SCHENECTADY, NEW YORK: Brazilian beam, 1700 to 2100				15.150	WRCA	NEW YORK CITY: European beam, 1115 to 1630; Brazilian beam, 1700 to 1845
11.820	GSN	LONDON, ENGLAND: 2300 to 0030; 0100 to 0500; 1030 to 1430; 1700 to 2030				15.150	KCBA	DELANO, CALIFORNIA: Alaskan beam, 2400 to 0315
11.830	WCBN	NEW YORK CITY: Caribbean beam, 1715 to 1745; Mexican beam, 1800 to 0100				15.150	KCBR	DELANO, CALIFORNIA: Philippine beam, 0400 to 1100
11.830	CXA19	MOSCOW, U.S.S.R.: 2200 to 0600; 0730 to 0945; 1100 to 1600				15.150	SBT	STOCKHOLM, SWEDEN: 0130 to 0215; 0600 to 0700; 1000 to 1315
11.830		MONTEVIDEO, URUGUAY: 0600 to 2200				15.160	JZK	TOKYO, JAPAN: 1730 to 1915
11.830		CONSTANTINE, ALGERIA: 0030 to 0300; 1200 to 1800				15.170	TGWA	GUATEMALA CITY, GUATEMALA: 1200 to 2000
11.840	VLC7	SHEPPARTON, AUSTRALIA: 0800 to 0915				15.180	GSD	LONDON, ENGLAND: 2300 to 1200; 1230 to 1745
11.840		PARIS, FRANCE: 0000 to 0045; 0100 to 0145; 0354 to 0515; 1045 to 1130; 1315 to 1730; 1830 to 2345				15.190	CKCX	MONTREAL, CANADA: 0800 to 1200
11.870	WBOS	BOSTON, MASSACHUSETTS: European beam, 0500 to 0715				15.190	TAQ	ANICARA, TURKEY: 0000 to 0200; 0415 to 0730
11.880		MOSCOW, U.S.S.R.: 2200 to 0600; 0720 to 1900				15.200	WOOC	NEW YORK CITY: European beam, 0900 to 1815
11.880	LRR	ROSARID, ARGENTINA: 0600 to 1800				15.210	WBOS	BOSTON, MASSACHUSETTS: European beam, 0915 to 1245; 1300 to 1545; South American beam, 1600 to 2200
11.880		MOSCOW, U.S.S.R.: 2200 to 0230						
11.890	KWIX	SAN FRANCISCO, CALIFORNIA: Japanese-Chinese beam, 0400 to 0900						
11.900	KWID	SAN FRANCISCO, CALIFORNIA: South Pacific beam, 0200 to 0630						
11.900	XGDY	CHUNGKING, CHINA: 0500 to 0630; 1045 to 1145						



"So this is the table model radio you ordered! And it's only large enough for Junior to eat from."

(Continued on page 56)

Now

YOU CAN HAVE IMPROVED No-DRIFT FM
in the Sensational New 1948

MIDWEST RADIOS

NEW SERIES 16*
SUPER DELUXE AM-FM CHASSIS



14 1/2" PANASONIC SPEAKER

5 WAVE BANDS

Here is the finest radio Midwest has ever produced in its 28 years of manufacturing—a world-ranging, 5-band radio with improved Midwest No-Drift FM . . . plus Standard Broadcast and 3 short wave bands, Television Audio Switch-over, and Color-Ray Tone Selection. The Series 16* Super De Luxe Chassis is a powerful, magnificently-toned radio that challenges comparison for performance, sensitivity, selectivity, and advanced engineering features. Supplied with satin stripe copper finish panel—ready to mount in your present cabinet. Send today for the FREE 1948 Midwest Radio Catalog. Buy your radio direct from the manufacturer on Easy Terms and 30 Days Trial and SAVE!

SERIES 16 CHASSIS USES ALL THESE LATEST-TYPE TUBES

30 DAYS TRIAL **LOW FACTORY-TO-YOU PRICES** **EASY TERMS**

A COMPLETE LINE OF FINE RADIOS AND RADIO-PHONOGRAPHS . . . Available in Separate Chassis Like the Powerful Series 16* AM-FM Model above, or in beautiful Radio-Phonograph Consoles like this:



SYMPHONY GRAND AM-FM RADIO-PHONOGRAPH CONSOLE with NEW Intermix AUTOMATIC RECORD CHANGER

Our Finest! A superbly beautiful musical instrument . . . masterpiece of furniture design and radio engineering that offers the sensational Midwest NO-DRIFT FM, Automatic Intermix Record-Changer, Exclusive Color-Ray Tone Selection, World-ranging 5-Band Reception, Television Audio Switch-Over, and many more new and exclusive features.

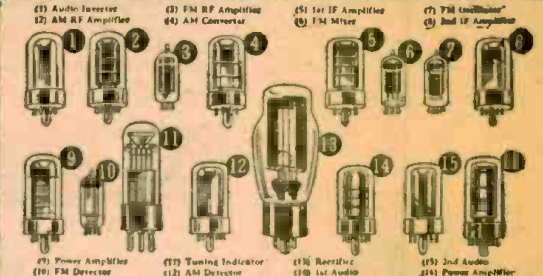

Scores of NEW Features such as the Exclusive MIDWEST TRI-MAGNADYNE COIL SYSTEM and COLOR-RAY TONE SELECTION

MIDWEST RADIO CORP.
Dept. 38-K • 909 BROADWAY • CINCINNATI 2, OHIO

Rush for Free Catalog!
FILL IN COUPON AND MAIL TODAY OR JUST SEND YOUR NAME AND ADDRESS ON 1c POSTCARD

MIDWEST RADIO CORP.
Dept. 38-K, 909 Broadway
Cincinnati 2, Ohio
Gentlemen: Please send me your new FREE catalog and details of your liberal 30 Days Trial.

Name.....
Address.....
City..... Zone..... State.....

NEW

RADIO-ELECTRONIC DEVICES

UNIVERSAL TESTER

Star Fuse Company, Inc.
New York, N. Y.

The Suretest universal tester is designed for voltage and continuity testing. It consists of a reel-like plastic frame, 6-foot vinyl-covered test leads, and a pair of test prods. Both prods have built-in 100,000-ohm resistors. The red, or positive, prod contains a built-in neon lamp that is viewed through holes in its barrel. The other end of the test leads terminate in a standard attachment plug.

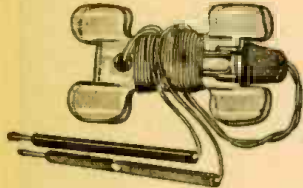

Since each prod is protected by a resistor, high and low voltages may be checked safely. Insert the plug in the short-circuited socket in the end of the frame. With the ends of the leads shorted, the lamp will indicate presence of voltages between 75 and 600 volts.

For continuity testing, the plug is inserted in a 117-volt outlet.—RADIO-CRAFT

ELECTRONIC MULTIMETER

Sylvania Electric Products Inc.
New York, N. Y.

The Type 134 Polymeter is a complete electronic multimeter including a balanced amplifier circuit practically independent of line voltage and normal amplifier tube changes; preset factory adjustments permitting correct zero setting for all ranges through 1 front panel adjustment; convenient range switch for correct multiplier values; 5 jacks for plug-in test-lead readings of a.c. volts, d.c. volts, ohms, amperes, and milliamperes.

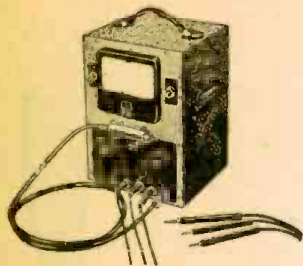

Measurement ranges of the Polymeter include: d.c. volts, 0-3, 0-10, 0-30, 0-100, 0-300, 0-1,000; a.c. volts, a.f., 20-15,000 c.p.s., 0-3, 0-10, 0-30, 0-100, 0-300; r.f. volts, 10 kc-300 mc, 0-3, 0-10, 0-30, 0-100, 0-300; d.c., 0-3 ma, 0-10 ma, 0-30 ma, 0-100 ma, 0-300 ma, 0-1,000 ma, 0-10 amperes; resistance, 0-1,000 ohms, 0-10,000 ohms, 0-100,000 ohms, 0-1 megohm, 0-10 megohms and 0-1,000 megohms.

The unit includes a midget probe utilizing the Type 1247 proximity-fuse-type tube.

The instrument cabinet measures approximately 10 inches high, 18 inches wide and 6 7/8 inches deep, weighs 16 pounds, and is rated at 30 watts input at 105-125 volts, 50-60 cycles a.c.—RADIO-CRAFT

ELECTRONIC ANALYZER

Weston Electrical Instrument Corp.
Newark, N. J.

The Model 769 analyzer embodies within one instrument a high-frequency

vacuum-tube voltmeter, an electronic volt-ohmmeter, and a 10,000-ohm-per-volt d.c. and 1,000-ohm-per-volt a.c. multimeter.

The v.t.v.m. is stable over wide variations in line voltage and covers a frequency range of 50 cycles to 300 mc without accessories or adapters, at ranges of 3/12/30/120 volts. Accuracy is 5% up to 150 mc, and 12% from 150 mc to 300 mc, direct reading. A corrective curve reduces this to 8% on the 150- to 300-mc range. The 3/2 inch long by 3/4 inch diameter r.f. probe is equipped with a flexible cable for plugging into the front panel. Input resistance is 5 megohms; capacity, 5 µf. The electronic volt-ohmmeter covers ranges from 3 to 1,200 volts, and 2,000 ohms to 2,000 megohms full scale, with stability uninfluenced by line-voltage variations.—RADIO-CRAFT

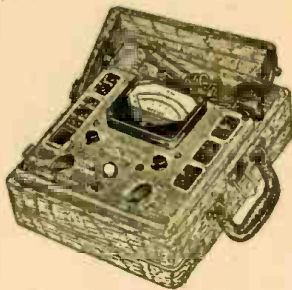

FREQUENCY METER

The Daven Company
Newark, N. J.

The Model 838 frequency meter is a direct-reading instrument designed to measure frequencies between 20 and 100,000 c.p.s. The accuracy on all ranges is ±2% of the top frequency of the range in use. Indication is substantially independent of variations in input voltages between 0.5 and 150 r.m.s.

A large illuminated meter is used. A



jack has been provided for connection to an external recording millimeter for making continuous graphic frequency recordings.—RADIO-CRAFT

5-WATT AMPLIFIER

Mark Simpson Mfg. Co., Inc.
Long Island City, N. Y.

The Masco MAP-105 is a self-contained, lightweight, 5-watt musical in-



strument amplifier. It has 2 inputs for mike or instrument, an 8-inch PM speaker, and a 2-tone fabricoid carrying case. It is designed for use as an instrument amplifier and will meet the needs of small halls and entertainment spots.—RADIO-CRAFT

FM ANTENNA

The Rauland Corp.
Chicago, Ill.

The Model 150 antenna is designed specifically for use on the 88- to 108-mc FM band. It has an omni-directional pickup pattern, requiring no special orientation.

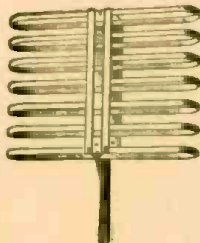

Sensitivity of the antenna is high, being rated at 3 decibels over a conventional dipole.

The unit is of aluminum construction, and its design offers low wind resistance.—RADIO-CRAFT

MULTITESTER

Bradshaw Instruments Co.
Brooklyn, N. Y.

The Model 10 Range Master multitester is interesting in that it incor-



porates a special 1-volt a.c. range for alignment work. Also included are 3 alternating-current ranges, the largest of which reads to 15 amperes. The others have maximums of 0.15 and 1.5 amps, respectively.

Other ranges are 0-10-100-500-1,000 volts a.c. and d.c., milliamperes ranges 0-1-10-100 d.c., and 3 resistance ranges to 1 megohm. Three capacitance ranges measure capacitors from 0.001 to 10 microfarads.—RADIO-CRAFT

MIDGET SOLDERING IRON

Industrial Heating Division
General Electric Co.,
Schenectady, N. Y.

The new Midget soldering iron is 8 inches long and weighs only 1 3/4 ounces, without the cord. It is rated at 25 watts, 6 volts, and uses a 115- to 6-volt step-down transformer. A transformer providing 4 taps for variable heat is available.

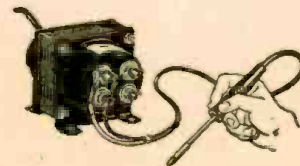

The Calrod heating element is built into the tip of the iron to within 1/2 inch of the working surface. Available tips are 1/8 and 1/4 inch in diameter.—RADIO-CRAFT

3-POSITION RELAY

Sigma Instruments, Inc.
Boston, Mass.

The new Type 6FXBA 3-position or null-indicating polarized relay is designed for use in relay-terminated control circuits and servo mechanisms.

When the coil is provided with 2 opposed windings for use in a push-pull output circuit, minimum differential power requirements are approximately .005 watt per contact pole, and operation is unaffected by variations in stand-by current. With a single-wound coil, about .0025 watt is needed per contact pole.

The armature has snap-action centering or detent, and does not move gradually with increasing coil current.

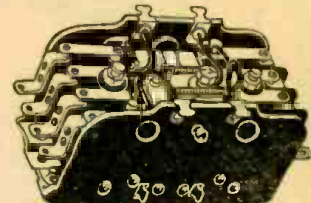

About 25 grams of force at the contacts are available from an input of .005 watt, and a similar amount for holding the central or null position, with input balanced or zero. The magnetic circuit being polarized, these forces increase directly with current up to nearly 200 grams. Contacts, which may be ganged in double-break or paralleled-pair arrangement, are rated at 5 amp 110 v a.c. Open or hermetically sealed types are offered.—RADIO-CRAFT

SOUND SYSTEM

Eastern Amplifier Corp.
New York, N. Y.

The Robomat is a combination radio, automatic phonograph, and paging system with a power output of 90 watts, designed for use in skating rinks, swimming pools, churches, schools, and other institutions.

It includes a microphone for instantaneous paging and a sensitive built-in AM radio.

The record changer is heavy duty and automatic. It stacks 20 records and plays both sides, or a total of 40 discs. This record changer can be operated for continuous periods on either a planned program, such as 1 record every 3 minutes, or on a continuously operating program. A timing device is incorporated in the Robomat, so it will turn itself on and off for any pre-adjusted time.—RADIO-CRAFT

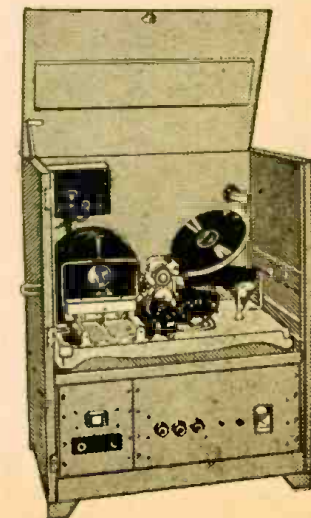

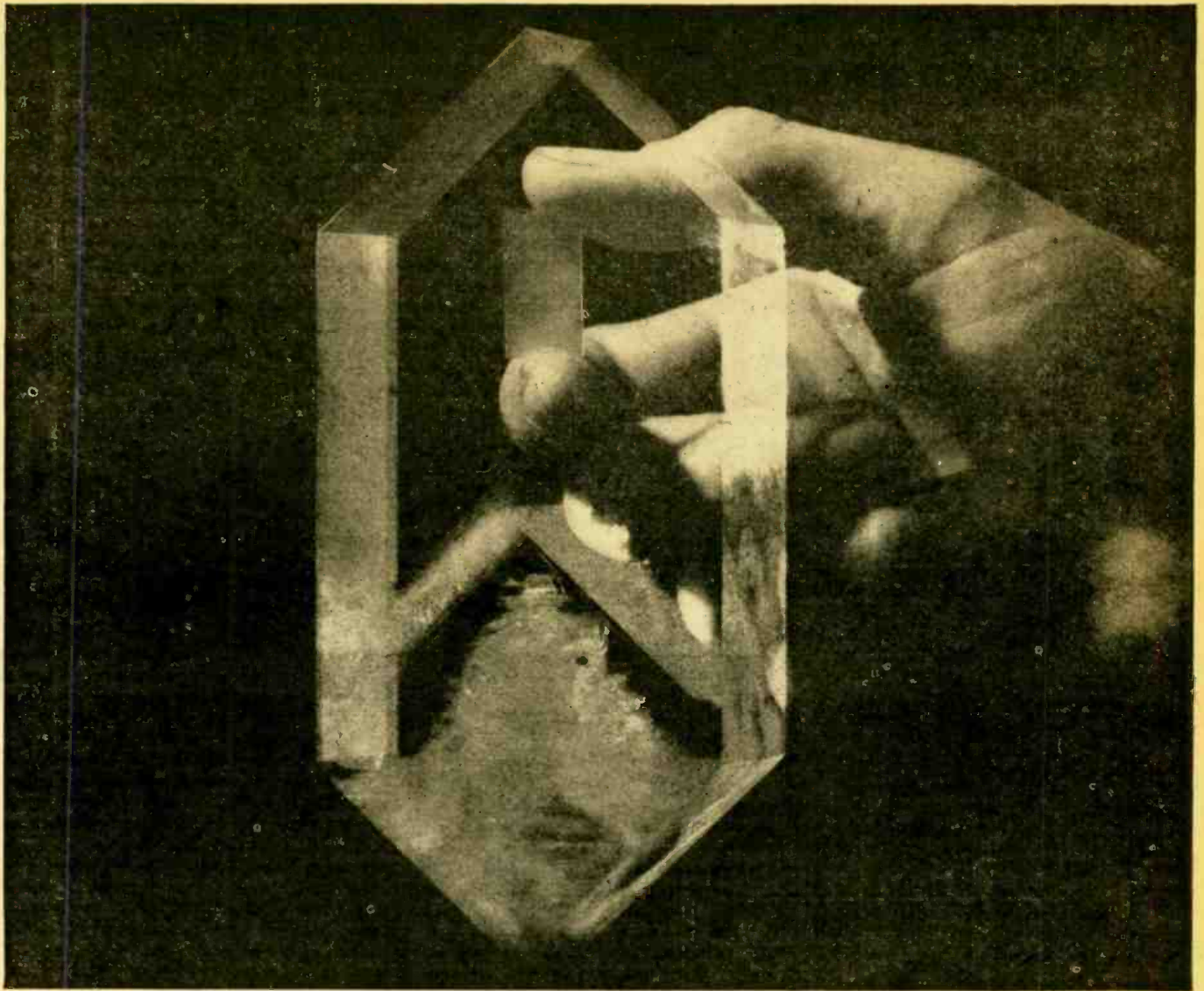

A CRYSTAL THAT GREW FROM A SEED . . . The large crystal in the foreground is an EDT (Ethylene Diamine Tartrate) crystal. It started from a seed (a piece of mother crystal) and in three months grew in a slowly cooling solution to the size shown. The small plate is cut from a large crystal, then gold-plated for electrical connection and mounted in vacuum. Cultivated EDT crystals can do the same job as quartz in separating the nearly 500 conversations carried by a coaxial circuit.

Crystals for Conversations

AT WAR'S END, the Bell System began to build many more Long Distance coaxial circuits. Hundreds of telephone calls can be carried by each of these because of electric wave filters, which guide each conversation along its assigned frequency channel. Key to these filters was their frequency-sensitive plates of quartz.

But there was not enough suitable quartz available to build all the filters needed. Bell Telephone Laboratories scientists met the emergency with cul-

tivated crystals. Years of research enabled them to write the prescription at once—a crystal which is grown in a laboratory, and which replaces quartz in these channel filters.

Now Western Electric, manufacturing unit of the Bell System, is growing crystals by the thousands. Many more Long Distance telephone circuits, in urgent demand, can be built, because the scientists of Bell Telephone Laboratories had studied the physics and chemistry of artificial crystals.



BELL TELEPHONE LABORATORIES

EXPLORING AND INVENTING, DEVISING AND PERFECTING, FOR CONTINUED IMPROVEMENTS AND ECONOMIES IN TELEPHONE SERVICE
RADIO-CRAFT for OCTOBER, 1947.

FREE! Radionic Catalog

LISTING: TELEVISION SETS • KITS AND COMPONENTS • PARTS • RADIOS • TEST INSTRUMENTS • INTERCOMMUNICATORS • DISC AND WIRE RECORDERS • PUBLIC ADDRESS • TUBES • AMATEUR EQUIPMENT • HARDWARE • RECORD CHANGERS • TECHNICAL BOOKS • ACCESSORIES.

SEND COUPON BELOW

LOOK TWICE at these VALUES

You won't believe 'em the first time.

- | | |
|---|----------|
| MICA CONDENSERS—500 volts wkg. .0001, .00025, .0005, .001, .0025, .005, .01, .02, .05, Any assortment. | 20 \$1 |
| CERAMICON CONDENSERS—.00003, .00005, .0001, .00025, .0005, .001, Any assortment. | 15 \$1 |
| CERAMICON TRIMMERS—1.5 to 7; 3 to 13, 5 to 20, 4 to 30, 7 to 45 mmf. Any assortment. | 7 \$1 |
| CARBON RESISTORS, Insulated, in 1/2 and 1 watt sizes except as indicated in footnote below.
6.8", 7", 8", 15", 38", 100", 150", 100", 150", 200, 300, 400, 500, 600, 700, 800, 1000, 1250, 1500, 2K, 2.5K, 3K, 3.5K, 4K, 5K, 6K, 7K, 7.5K, 8K, 9K, 10K, 12K, 15K, 17K, 20K, 25K, 30K, 40K, 50K, 60K, 70K, 75, 100K, 125K, 150K, 200K, 250K, 300K, 400K, 500K, 750K, 1M, 2M, 3M, 4M, 5M, 6M, 7M, 8M, 9M, 10M.
‡ also 2 watt, * 1/2 watt only.
K=1000, M=1m-g. | 50 \$1 |
| 1/2 watt, any assortment (100 for \$1.75) | for |
| 1 watt, any assortment (100 for \$2.25) | 40 \$1 |
| 2 watt, any assortment (100 for \$3.75) | 25 \$1 |
| POWER RESISTORS—4000 ohm 12 watt, 300 ohm 10 watt, 2000 ohm 20 watt, any assortment | 10 \$1 |
| SOCKETS—Low loss phenolic octal with retainer rings | 15 \$1 |
| COIL FORMS—Ceramic, grooved 6 1/2 in. long, 2 in. dia. | 12 \$1 |
| OSCILLATOR COIL—Melasner, unshielded for 6SA7, 12SA7, etc. 456 kc. | 10 \$1 |
| NATIONAL HR0-7 (complete) | \$311.36 |
| NATIONAL NC46 (with speaker) | 107.40 |
| HALLIGRAFTERS SX38 (complete) | 47.50 |
| HALLIGRAFTERS SX42 (less speaker) | 275.00 |
| HALLIGRAFTERS R42 SPKR for SX42 | 29.50 |
- Complete Line of National and Halligrafters

It's RADIONIC for RELIABILITY

TERMS: Remittance with order plus postage or 25% deposit, balance C.O.D.

RADIONIC EQUIPMENT COMPANY

DEPT. 1010 TRIBUNE THEATRE ENTRANCE 170 NASSAU ST., N. Y. 7, N. Y. WOrth 2-0421

RADIONIC Equipment Co., Dept. 1010 170 Nassau St., New York 7, N. Y.

Gentlemen: Please send your free catalog No. 47, listing products of leading manufacturers of radio electronic parts and equipment, especially designed for Service Dealers, Amateurs, Experimenters, Industrials, Institutions, Govt. Agencies; also, all bargain offerings as published.

Name _____
 P.O. Box or Street _____
 Town _____
 Zone _____ State _____

MAIL TODAY

RADIO-ELECTRONIC CIRCUITS

SIMPLE STROBOSCOPE

A stroboscope is useful in studying machinery in rapid motion and has applications in home workshops, laboratories, and industry. It can be used for measuring the speed of rotating or reciprocating machine parts. The circuit of a simple stroboscope, presented in *Electronics*, uses an 884 relaxation oscillator, a 6K6 tube, and a neon lamp.

pulses that are applied to the grid of the 6K6. The plate of this tube is coupled to the neon lamp through a 3:1 step-down transformer. A small adjustable spark gap across the primary protects the transformer against voltage breakdown should the neon lamp be disconnected. The lamp is a 2- or 3-watt unit without built-in limiting resistor. The

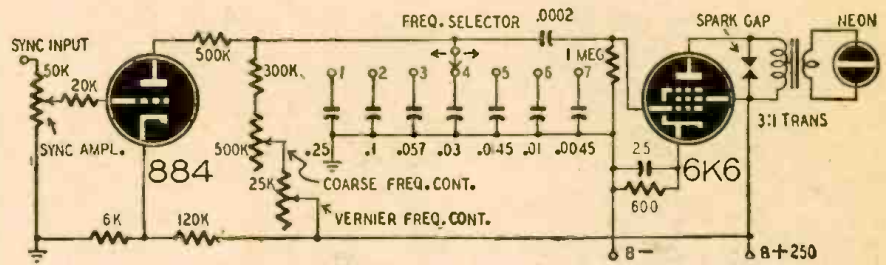

The 884 generates saw-tooth waves at frequencies determined by the settings of the frequency selector and coarse and vernier frequency controls. Frequency ranges are 15 to 30, 30 to 60, 60 to 120, 120 to 240, 180 to 400, 360 to 650, and 650 to 1400 cycles as the frequency range selector is rotated through positions 1 to 7. The 884 may be synchronized with an external signal source connected to the sync input terminal. Strength of the sync injection voltage is controlled by the sync amplitude control.

controls can be calibrated directly in frequency by using an oscilloscope and a known standard such as an accurate audio oscillator or the power-line frequency.

If the blades of a rapidly turning electric fan are lighted by the neon lamp, they will appear motionless as the frequency controls are varied. A number of interesting effects will be noted when a disc, with a single stripe radiating from its center, is placed on a phonograph turntable and lighted by the lamp. The stripe will appear as one or more spokes on the disc as the speed of the motor or frequency of the stroboscope is varied.

The 200- μ f condenser and 1-megohm resistor form a differentiating network to convert saw-tooth waves to sharp

30-45-WATT AUDIO AMPLIFIER

Transmitting-type power amplifier tubes such as 807's or 1625's may be used in medium-power audio amplifiers and modulators in place of more commonly used 6L6's. The 807's deliver equal power with less distortion. The

circuit of a 30-watt amplifier, described in *Radiotronics* (Australia), can be converted to deliver 45 watts with minor changes in component values.

The 6SJ7-GT voltage amplifier sup-
 (Continued on page 78)

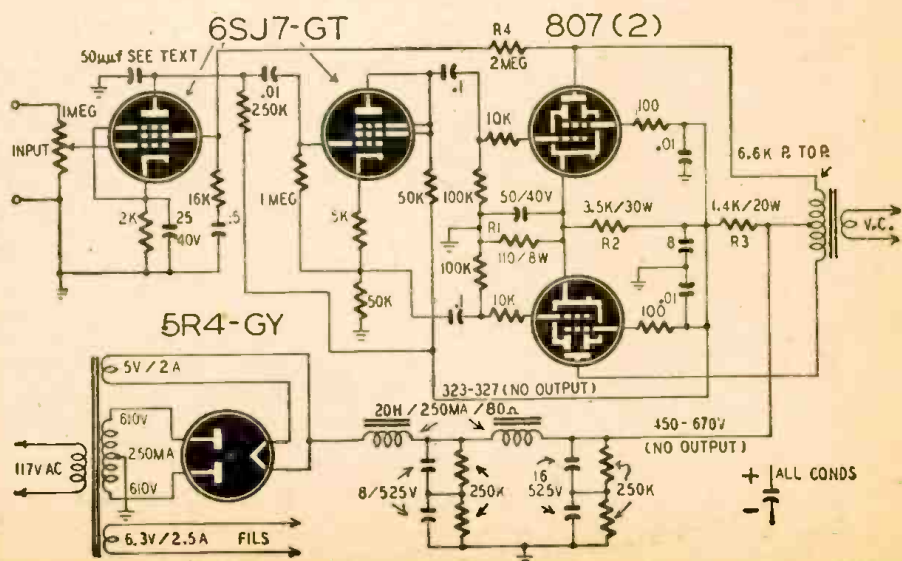

MONEY BACK GUARANTEE — We believe units offered for sale by mail order should be sold only on a "Money-Back-If-Not-Satisfied" basis. We carefully check the design calibration and value of all items advertised by us and unhesitatingly offer all merchandise subject to a return for credit or refund. You, the customer, are the sole judge as to value of the item or items you have purchased.

The New KT-30 CHANNEL ANALYZER

The Ultimate in Signal Tracing Includes . . .

METER—For direct reading of signal intensity.

SPEAKER—For listening to the signal.

PHONE—For checking distortion and listening to the signal in low-gain channels.

Comparative signal intensities indicated directly on the meter as Probe follows the signal. A special 4½" P.M. speaker with oversize Alnico V magnet is used for quality checks. Many previously designed Signal Tracers were unable to measure and check low signal intensities. This disadvantage has now been overcome for the Model KT-30 incorporates a special circuit which permits the meter to be put across the output of the Signal Tracer. To accomplish this it is necessary only to flip a front panel switch. This results in additional gain and sensitivity permitting measurement of low signal intensities. An earphone provided with the unit permits listening to the signal in low-gain channels. Incidentally, insertion of the phone automatically cuts out the speaker.

\$29⁹⁵
NET

Complete with detector probe, test leads, self-contained batteries and earphone. Heavy-gauge crystalline cabinet.



The New Model 650-A A. C. Operated SIGNAL GENERATOR



- Operates on 110-120 Volts 50 to 60 Cycles A.C.

- R.F. Frequencies from 100 Kc. to 35 Mc. on Fundamentals in 3 bands by front panel switch manipulation. One additional band provides Harmonics from 30 to 105 Mc.

- Audio Modulating Frequency —400 Cycles Pure Sine Wave. Distortion less than 3%.

- Attenuation: Features a newly designed 3-step ladder type of attenuator (T pad). The first step provides lowest output and can be multiplied by 10 and by 100 by turning the multiplier switch.

- Hartley Excited Oscillator Electron, coupled to a Buffer Amplifier. Frequency stability is assured by modulating the amplifier stage.

Complete with coaxial cable, test leads and instructions. Heavy gauge grey crystalline cabinet with beautiful two tone etched front panel. Size 9½" x 10" x 6".

\$39⁹⁵
NET

The New Model 670 SUPER METER

A Combination Volt-Ohm-milliammeter plus Capacity Reactance, Inductance and Decibel Measurements



D.C. VOLTS: 0 to 7.5/15/75/150/750/1500/7500.

A.C. VOLTS: 0 to 15/30/150/300/1500/3000 Volts.

OUTPUT VOLTS: 0 to 15/30/150/300/1500/3000.

D.C. CURRENT: 0 to 1.5/15/150 Ma.; 0 to 1.5 Amps.

RESISTANCE: 0 to 500/100,000 ohms 0 to 10 Megohms.

CAPACITY: .001 to .2 Mfd., .1 to 4 Mfd. (Quality test for electrolytics).

REACTANCE: 700 to 27,000 Ohms; 13,000 Ohms to 3 Meg-ohms.

INDUCTANCE: 1.75 to 70 Henries; 35 to 8,000 Henries.

DECIBELS: -10 to +18, +10 to +38, +30 to +58. The Model 670 comes housed in a rugged, crackle-finished steel cabinet complete with test leads and operating instructions. Size 5½" x 7½" x 3".

\$28⁴⁰
NET

The New Model CA-11 SIGNAL TRACER



Simple to operate . . . because signal intensity readings are indicated *directly on the meter!*

- ★ **SIMPLE TO OPERATE** —only 1 connecting cable —**NO TUNING CONTROLS.**

- ★ **HIGHLY SENSITIVE**—uses an improved Vacuum Tube Voltmeter circuit.

- ★ Tube and resistor-capacity network are built into the Detector Probe.

- ★ **COMPLETELY PORTABLE** — weighs 5 lbs. and measures 5"x6"x7".

- ★ Comparative Signal Intensity readings are indicated directly on the meter.

meter as the Detector Probe is moved to follow the Signal from Antenna to Speaker.

★ Provision is made for insertion of phones. The Model CA-11 comes housed in a beautiful hand-rubbed wooden cabinet. Complete with Probe, test leads and instructions.

\$18⁷⁵
NET

The New Model 450 TUBE TESTER

Speedy operation — assured by the newly designed rotary selector switch which replaces the usual snap, toggle, or lever action switches.

SPECIFICATIONS

- Tests all tubes up to 117 volts.
- Tests shorts and leakages up to 3 Megohms in all tubes.
- Tests both plates in rectifiers.
- New type line voltage adjuster.
- Tests individual sections such as diodes, triodes, pentodes, etc., in multi-purpose tubes.
- Noise Test—detects microphonic tubes or noise due to faulty elements and loose internal connections.

- Uses a 4½" square rugged meter.
- Works on 90 to 125 volts 60 cycles A.C.

EXTRA SERVICE—May be used as an extremely sensitive condenser Leakage Checker. A relaxation type oscillator incorporated in this model will detect leakages even when the frequency is one per minute.

\$39⁵⁰
NET

GENERAL ELECTRONIC DISTRIBUTING CO. DEPT. RC-10, 98 PARK PLACE, NEW YORK 7, N. Y.

In New Jersey...
..it's **VARIETY**
Sensationally New

TRANSVISION

12" TELEVISION KIT

STANDARD MODEL
—Picture size 7 1/2 square inches, 22 tubes and 12 inch picture tube. High fidelity FM sound reproduction. Advanced television circuit provides exceptionally clear pictures.



DELUXE MODEL—with Superb Built-in FM Radio.
12" Standard Television Kit..... \$289.50*
12" Deluxe Television—FM Radio Kit..... 359.50*
7" Television Kit..... 159.50*
(*Complete with tubes, lens cabinet)
Cabinet for 12" Television Receiver..... 44.95

DEALERS' PRICES ON REQUEST

NEW! PREMIER Model 570 MICROMASTER Band Spread Dial SIGNAL GENERATOR



For testing and aligning BROADCAST, SHORT WAVE, FM and TELEVISION RECEIVERS. Exclusive Band Spread Dial geared to the tuning condenser and main dial, giving a total scale length of approximately 60 inches. Three-color dial directly calibrated in Kilocycles and Megacycles. Range: 75 KC—150MC. Size: 12 1/2" x 12" x 5 1/2".

COMPLETE WITH TUBES AND CO-AXIAL CABLE. \$5475 NET

6" PM SPEAKERS \$7.49 5 FOR

1/2 meg. VOL. CONTROL with SWITCH (Claro-stat) 3/4" length shaft. 10 for \$4.59

1/2 meg. VOL. CONTROL without SWITCH (Claro-stat) 1 1/2" length shaft. 10 for \$2.49

HOWARD SAMS Photo Fact Folders ea. \$1.50
HOWARD SAMS Photo Fact Folders ea. \$18.39
Vol. I and II.

Bargain! Guaranteed!

100 Assorted Bypass Condensers 600V
Value \$11.00. SPECIAL \$6.95

SUPERIOR Model 670

Super-Meter



A Combination Volt - Ohm Milliammeter plus Capacity Reactance Inductance and Decibel Measurements.

Complete with test leads and instructions \$28.40

Full line of Weston-R.C.P.-Supreme Superior-E.M.C.-Test Equipment

Write Dept. RC-10, 20% Deposit with order required. Please add sufficient postage. Excess will be refunded.

Variety **ELECTRIC CO., Inc.**
601 Broad St., Newark 2, N. J.

TRY THIS ONE

ANTENNA LEAD ROLLER

To keep my antenna lead-in off the service bench when not in use I use the kink described.

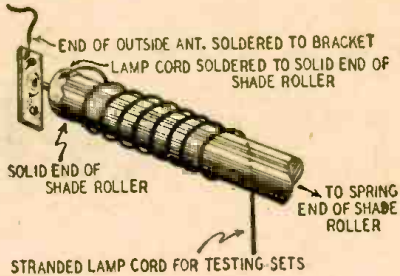

Select a discarded shade roller, with spring in good condition. Use a small awl to punch a series of holes in the roller to locate the end of the spring. Saw off the solid portion 1 or 2 inches beyond the end of the spring, and replace the metal spindle and cap from the discarded end. Make sure the metal spindle makes good contact with the cap. Wind a length of flexible lead-in wire around the roller and solder one end to the cap.

Mount a pair of shade brackets at a convenient place above the bench and connect the antenna to the bracket at the solid end of the roller. When the spring is wound tightly, the lead-in may be pulled out to any length or rolled up at will.

OSCAR E. MALECH,
San Francisco, Calif.

CALIBRATING TANK COILS

To determine the frequency range of a variable tank circuit in which component values are unknown, insert the coil and condenser combination in series with the antenna lead of an all-wave receiver. If the range of the tank falls within one of the bands of the receiver, it becomes a series wave trap. Tune in a signal on the radio and adjust the tank until the signal fades to a mini-

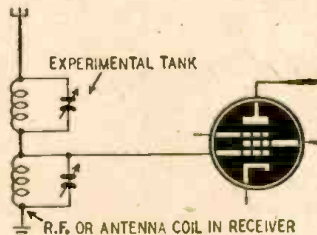

mum. At this point, the resonant frequency of the tank is equal to that of the receiver and can be read directly off the tuning dial. In this way it is possible to determine the tuning limits of any coil and condenser combination.

AL HAUSER,
W. Lafayette, Ind.

PROTECTING TEST LEADS

Test leads left lying on the work bench have often been burned and otherwise damaged. I now have a system that

protects leads not in use. The meter is mounted on a sloping panel, and permanent test leads brought out behind the panel and passed through 2 small holes in the top of the bench. Knots that cannot pass through the holes are made in the leads to protect the meter and connections against strain. The leads are brought up through holes in the front surface of the bench after weighted pulleys have been placed on them as

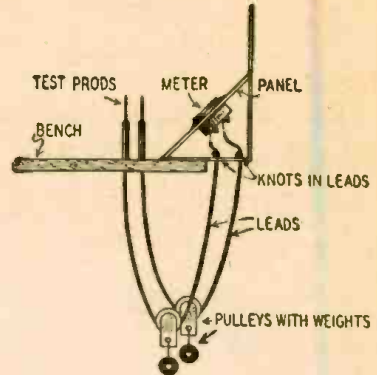

shown. These holes are large enough to permit the leads to slide without binding but will not pass the prods.

CARL E. PORTER,
Bronx, N. Y.

(This system is also handy for antenna and ground leads.—Editor)

SPEAKER CONE SHIELD

As soon as a radio is removed from its cabinet for servicing, cover the front of the speaker with an oil-silk or plio-film dish cover. These are obtainable from 5 & 10-cent stores in a number of sizes that can be used on speakers up to about 15 inches in diameter. The covers prevent the cone from being damaged by tools or other instruments on the bench and keep dust and metal filings from lodging between the voice coil and the pole piece.

HARLEM RADIO CLUB,
New York, N. Y.

FIELD STRENGTH METER

Useful for u.h.f. and v.h.f. work, this field strength meter consists of a modified half-wave folded dipole mounted on a lightweight wooden frame. A plastic cup of bakelite (headphone case) in the center of the T houses the condenser and crystal diodes and supports the antenna at the center. The ends of the dipole are supported on stand-off insulators.

Full-wave rectifiers double the sensitivity of the instrument, making it possible to use d.c. milliammeters with ranges as high as 10 ma. The folded dipole tunes broadly, and tuning is unnecessary when covering any u.h.f. or v.h.f. band.

JAMES R. WHEELER, W9ECI,
Oshkosh, Wisconsin.

All Brand New RADIO TUBES!

Save up to 80%

ALL STANDARD BRANDS - ALL IN CARTONS

Type	Price	Type	Price	Type	Price
*024	1.10	6J5GT	.62	12K7GT	.67
1ASGT	.75	6J6	1.32	*12K8	1.10
1A7GT	.90	*6J7	.90	12Q7GT	.62
1B5/25S	.90	6K5GT	.95	*12SA7GT	.90
1C5GT	.90	6K6GT	.67	*12SC7	.90
1G4GT	.90	*6K7	.75	12SF5GT	.75
1H4G	.90	6K8GT	.90	*12SF7	.90
1H5GT	.75	6L5G	.75	*12SG7	.90
1L4	1.10	6L8G	1.32	*12SH7	.90
1LA4	1.60	*6L9	1.10	12S17GT	.75
1LA6	1.60	6N7GT	1.10	12SK7GT	.75
1LB4	1.60	6P5GT	.90	12SL7GT	1.10
1LC5	1.60	*6Q7	.90	12SN7GT	.90
1LC6	1.60	*6R7	1.10	12SQ7GT	.75
1LD5	1.60	6SA7GT	.75	*12SR7	.90
1LH4	1.60	*6SB7Y	1.32	12T3	.57
1LN5	.90	*6SC7	.90	14A7/12B7	1.32
1NSGT	.90	6SD7GT	1.32	14H7	1.10
1Q5GT	1.10	6SF5GT	.90	14Q7	1.10
1R5	1.10	*6SF7	.90	14R7	1.10
1S4	1.10	*6SG7	.90	24A	.67
1S5	1.10	6SH7GT	.90	25L6GT	.75
1T4	1.10	6SI7GT	.75	25Z5	.67
1T5GT	1.10	6SK7GT	.75	25Z6GT	.52
1U4	.62	6SL7GT	1.10	26	.47
1V	1.32	6SN7GT	.90	27	.47
2A3	1.10	6SQ7GT	.75	30	.90
2A6	1.10	*6SR7	.75	32L7GT	1.60
3Q4	1.10	*6SS7	.67	35/51	.67
3Q5GT	1.10	*6ST7	1.10	35A5	.90
3S4	1.10	6SU/6G5	.90	35B5	.90
3V4	1.10	6U7G	.67	35L6GT	.67
*5T4	1.32	*6V6	1.32	35W4	.57
5U4G	.67	6V6GT	.75	35Z3	.90
5V4G	1.10	6X5GT	.67	35Z4GT	.55
5W4GT	.62	6Y6G	1.10	35Z5GT	.57
5X4G	.75	7A4	.90	36	.67
5Y3GT	.47	7A5	.90	37	.57
5Y4G	.52	7A6	.90	38	.75
5Z3	.75	7A7	.90	39/44	.67
*5Z4	.90	7A8	.90	41	.57
6A6	.10	7B5	.90	42	.57
6A7	.67	7B6	.90	43	.90
*6A8	.90	7B7	.90	45	.55
*6AB7/1853	1.32	7B8	.90	45Z3	.75
6AF5GT	.90	7C5	.90	45Z5GT	.75
*6AC7/1852	1.32	7C6	.90	46	1.10
6AD7G	1.10	7C7	.90	47	.75
6AF6G	1.10	7C8	.90	50B5	.90
6AG5	1.60	7E5	.90	50L6GT	.75
*6AG7	1.60	7E6	.90	50Y6GT	.75
6AK5	.90	7E7	1.10	53	1.10
6AL5	.90	7F7	1.10	55	.75
6AOS	.90	7F8	1.32	56	.57
6AQ7GT	1.10	7G7/1232	1.32	57	.62
6AT6	.75	7H7	1.32	70L7GT	1.95
6R4G	1.32	7J7	1.32	71A	.62
6B7	.90	7K7	1.32	75	.57
*6B8	1.32	7L7	1.32	78	.62
6BA6	.90	7N7	1.32	77	.62
6BE6	.90	7Q7	.90	78	.62
6C4	.75	7V7	1.60	80	.47
*6C5	.75	7Y4	.90	81	1.32
6C6	.67	*12A6	1.32	82	.90
6C8G	1.10	12A8GT	.67	83	.90
6D6	.67	12AT6	.75	84/6Z4	.75
6D8G	1.10	12BA6	.90	85	.62
6E5	.75	12BE6	.90	89	.27
*6F6	.75	*12C8	1.32	117L7/M7GT	1.95
6F8G	.90	*12H6	.75	117N7GT	1.60
6G6G	.90	12J5GT	.67	117P7GT	1.60
*6H6	.75	12J7GT	.75	117Z6GT	1.10

*Metal Types

*Metal Types

*Metal Types



V.H.F. TRANSMITTER

Here is one of the greatest offerings in war surplus! Hundreds sold at 20 and new closed out at an amazingly low price. Brand new. Battery operated (67 1/2 v B and 1 1/2 v A). Frequency 80 to 105 mc. Complete with 2-1G4 tubes and full instruction manual. Ready to go on the air.

Less batteries \$6.95

All items F.O.B., Washington, D. C. All orders \$30.00 or less cash with order. Above \$30.00, 25 per cent with order balance C.O.D. Foreign orders cash with all orders plus exchange rate.

Hot Radio Values AT SUN RADIO

100 WATT BENDIX TRANSMITTER TA12



CHECK THESE VALUES: Three 807 Tubes, four 12SK7, one 2 inch 5 amp. RF meter, four Separate Master oscillators. (These can be easily changed to cover 20-40-80 meters and by using crystal for the 10 meter band, you will have a complete coverage transmitter.)

Four separate output tanks. One 4 position selector channel switch having seven sections which changes the ECO, IPA and output tanks simultaneously. All the controls are mounted on the front panel. The housing is cast aluminum; shields and case are sheet aluminum. Dimensions 11 x 12 x 15 inches, weighing 35 1/4 lbs. Complete, simple instructions for conversion furnished. Complete with tubes \$49.95



SUPERHETERODYNE RECEIVER

This crystal fixed frequency receiver comes with full conversion instruction for variable tuning of all ham bands and broadcast. A highly selective superheterodyne receiver, 110 V.A.C. power supply built in. Using the following tubes: 6K7-RF Amplifier; 6K8 Mixer and Oscillator; 6K7 I.F. Amplifier; 6F7-Detector and A.V.C.; 6C8 Output and Noise Suppressor; 80 Rectifier. Dimensions—3 1/2 x 19 x 11 1/2 inches. Comes complete, brand new, with one set of coils and two sets of tubes \$16.95

Extra set of coils \$1.95

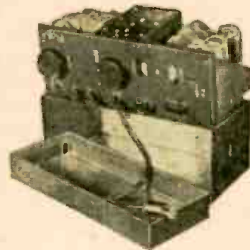

HAM AND POLICE SUPERHET TUNER

Brand New. Complete with 7V7 (1 Stage T.R.F.), 7Q7 (1st IF & Osc.), 7V7 (2nd IF), 7F7 (Audio) and 7V7 (BFO). Frequency 2.4 to 16.3 mc. Filament voltage required 6.3 AC or DC -2.1 amp. Plate voltage required 135V DC-30MA. Only 4 1/2 x 9 1/2 x 3 3/4" and weighs only 6 1/2 lbs. Ideal for Ham and Police \$14.95



G.I. PORTABLE WINDUP PHONOGRAPH

A high quality, sturdily built, full toned windup phono originally built for armed forces as morale phono. Special triple spring motor plays 3 records on 1 winding. Speed adjustable from 33-78 revs. Brand new packed with 100 multiple play needles \$19.95

MICROPHONE

\$1.79

Brand new single button carbon hand mike by "Shure" with push to talk switch.



D.C. MILLIAMMETER

Brand new General Electric 2" round panel meters 0-300.



\$2.97



AUTOMATIC RECORD PLAYER

Including Webster No. 50 changer, three tube amplifier, 5" Alnico V Speaker in a deluxe leatherette case. List \$57.50

YOUR COST \$31.95



VM RECORD CHANGER

Brand New. Mixes 10 and 12" records.

\$16.95

Wood Base for above \$3.49

SUN RADIO

OF WASHINGTON, D. C.

938 F STREET, N. W. WASH. 4, D. C.

TRANSVISION

Scores Another
Great Scoop!

The DeLuxe

7" TELEVISION KIT with a Complete FM RADIO

covering the entire FM BAND
(88 to 108 MC)



Now... build yourself a magnificent two-in-one receiver—Television and FM Radio—and save more than 50% on the comparative cost of a completed set.

Wire up the DeLuxe 7" Transvision Kit, install the FM Radio which comes with it and requires no assembly, and you have a receiver worth over \$400.00.

Note These Outstanding Features

- You get the famous 7" Transvision Television Kit, plus—
- A superb high quality, high fidelity FM Radio which covers the entire FM Band, from 88 to 108 MC. Radio comes assembled ready to install.
- FM front end as well as the television front end are completely wired and tuned.
- You get ALL the parts, including front panel, specially designed FOLDED DIPOLE ANTENNA and 60 ft. of low-loss lead in cable.
- NO TECHNICAL KNOWLEDGE REQUIRED for assembly. No instruments required.
- As easy to assemble as the standard 7" Transvision Television Kit.
- DeLuxe 7" TRANSVISION TELEVISION KIT with FM RADIO RECEIVER. LIST \$199.00

Beautiful furniture finish cabinet list \$32.50

FM CONVERSION KIT

You can incorporate a complete FM radio into your present television receiver by means of the Transvision FM conversion kit. LIST \$29.95

If your kit already has FM sound, a conversion to FM radio will cost even less. Ask your distributor.

See your local distributor, or for further information write to:

TRANSVISION INC. Dept. R. C.
385 North Ave., New Rochelle, N. Y.



? TWO-TUBE SUPERHET

I have a 2-circuit permeability tuner for a superhet and would like a diagram showing how this may be used in a 2-tube battery radio. If possible, I would like to use a 1A7-GT and a 1N5-GT.—J.C., Hollywood, Calif.

A. This superhet uses a conventional permeability-tuned, oscillator-mixer circuit feeding into a 1N5-GT regenerative detector. The regenerative winding consists of 20 turns of No. 20 d.c.c. wire, wound at the lower end of the i.f. transformer core.

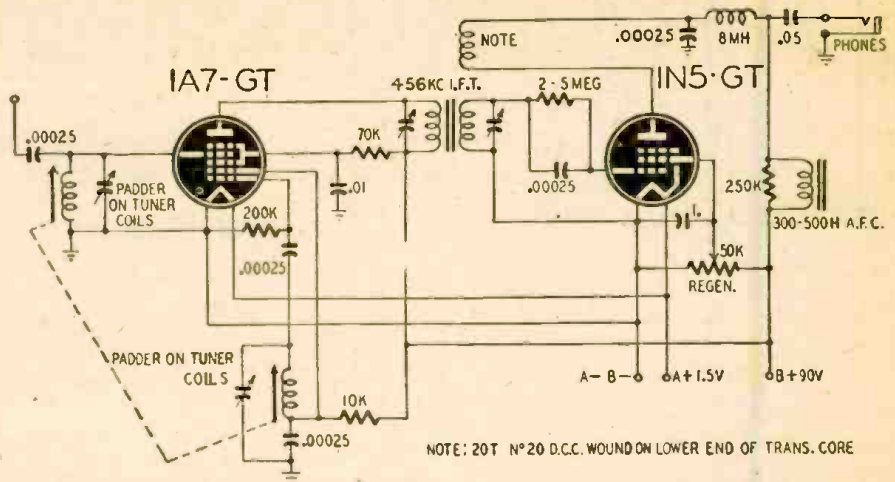

? PHONO AMPLIFIER

I would like to have a diagram of a phono amplifier having two input stages with 6F5's and a 6SJ7 trans-

former coupled to push-pull 6V6's. I want to use selenium rectifiers in a voltage doubler circuit.—H.S., Woodbury, N. J. (Continued on page 78)

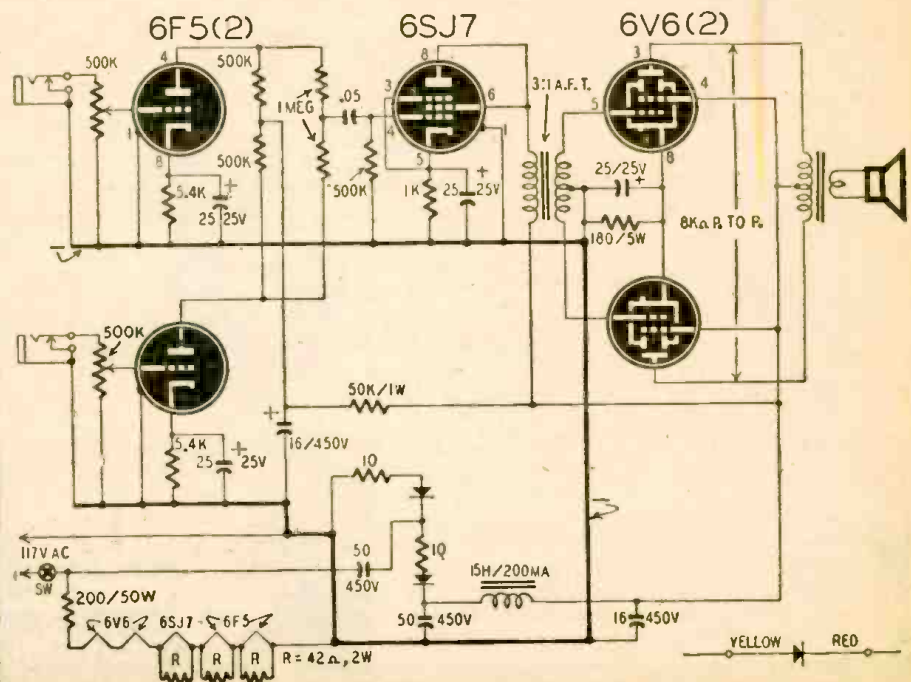

TRANSVISION

Scores Another
Great Scoop!

The DeLuxe

7" TELEVISION KIT with a Complete FM RADIO

covering the entire FM BAND
(88 to 108 MC)



Now... build yourself a magnificent two-in-one receiver—Television and FM Radio—and save more than 50% on the comparative cost of a completed set.

Wire up the DeLuxe 7" Transvision Kit, install the FM Radio which comes with it and requires no assembly, and you have a receiver worth over \$400.00.

Note These Outstanding Features

- You get the famous 7" Transvision Television Kit, plus—
- A superb high quality, high fidelity FM Radio which covers the entire FM Band, from 88 to 108 MC. Radio comes assembled ready to install.
- FM front end as well as the television front end are completely wired and tuned.
- You get ALL the parts, including front panel, specially designed FOLDED DIPOLE ANTENNA and 60 ft. of low-loss lead in cable.
- NO TECHNICAL KNOWLEDGE REQUIRED for assembly. No instruments required.
- As easy to assemble as the standard 7" Transvision Television Kit.
- DeLuxe 7" TRANSVISION TELEVISION KIT with FM RADIO RECEIVER.
LIST \$199.00

Beautiful furniture finish cabinet list \$32.50

FM CONVERSION KIT

You can incorporate a complete FM radio into your present television receiver by means of the Transvision FM conversion kit.....LIST \$29.95

If your kit already has FM sound, a conversion to FM radio will cost even less. Ask your distributor.

See your local distributor, or for further information write to:

TRANSVISION INC. Dept. R. C.
385 North Ave., New Rochelle, N. Y.

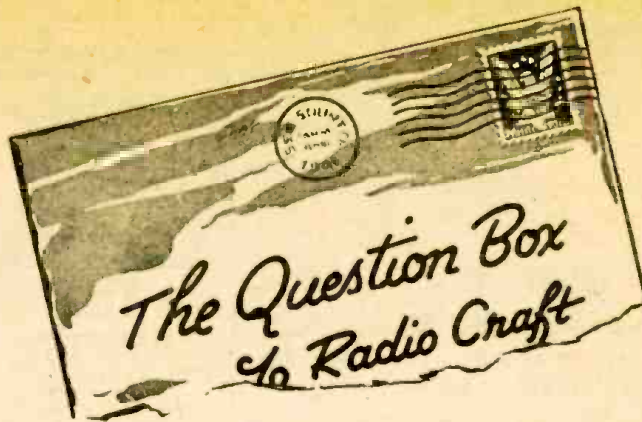

? TWO-TUBE SUPERHET

I have a 2-circuit permeability tuner for a superhet and would like a diagram showing how this may be used in a 2-tube battery radio. If possible, I would like to use a 1A7-GT and a 1N5-GT.—J.C., Hollywood, Calif.

A. This superhet uses a conventional permeability-tuned, oscillator-mixer circuit feeding into a 1N5-GT regenerative detector. The regenerative winding consists of 20 turns of No. 20 d.c.c. wire, wound at the lower end of the i.f. transformer core.

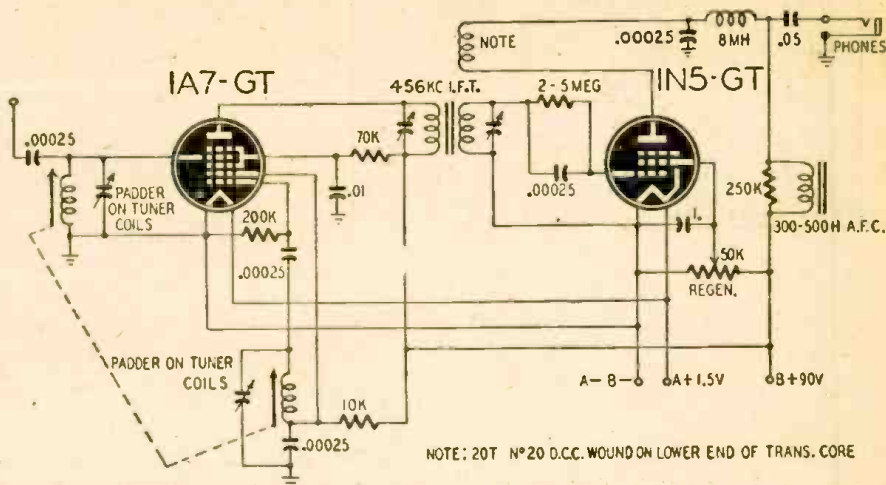

? PHONO AMPLIFIER

I would like to have a diagram of a phono amplifier having two input stages with 6F5's and a 6SJ7 trans-

former coupled to push-pull 6V6's. I want to use selenium rectifiers in a voltage doubler circuit.—H.S., Woodbury, N. J. (Continued on page 78)

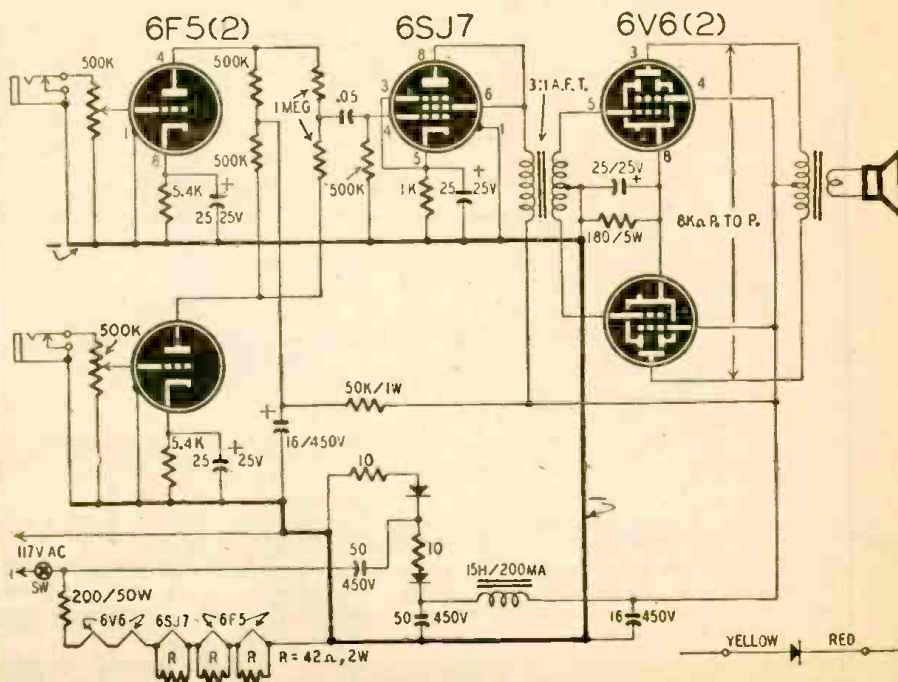

All Brand New RADIO TUBES!

Save up to 80%

ALL STANDARD BRANDS - ALL IN CARTONS

Type	Price	Type	Price	Type	Price
*024	1.10	6J5GT	.62	12K7GT	.67
1A5GT	.75	6J6	1.32	*12K8	1.10
1A7GT	.90	*6J7	.90	12O7GT	.62
1B5/25S	.90	6K5GT	.95	12SA7GT	.90
1C5GT	.90	6K6GT	.67	*12SC7	.90
1G4GT	.90	*6K7	.75	12SF5GT	.75
1H4G	.90	6K8GT	.90	*12SF7	.90
1H5GT	.75	6L5G	.75	*12SG7	.90
1L4	1.10	6L6G	1.32	*12SH7	.90
1LA4	1.60	*6L7	1.10	12S17GT	.75
1LA6	1.60	6N7GT	1.10	12SK7GT	.75
1LB4	1.60	6P5GT	.90	12SL7GT	1.10
1LC5	1.60	*6Q7	.90	12SN7GT	.90
1LC6	1.60	*6R7	1.10	12SO7GT	.75
1LD5	1.60	6SA7GT	.75	*12SR7	.90
1LH4	1.60	*6SB7Y	1.32	12T3	.57
1LN5	1.60	*6SC7	.90	14A7/12B7	1.32
1NSGT	.90	6SD7GT	1.32	14H7	1.32
1OSGT	1.10	6SF5GT	.90	14Q7	1.10
1RS	1.10	*6SF7	.90	14R7	1.10
1S4	1.10	*6SG7	.90	24A	.67
1S5	1.10	6SH7GT	.90	25L6GT	.75
1T4	1.10	6SJ7GT	.75	25Z5	.67
1T5GT	1.10	6SK7GT	.75	25Z6GT	.67
1U4	.90	6SL7GT	1.10	26	.52
1V	.62	6SN7GT	.90	27	.47
2A3	1.32	6SQ7GT	.75	30	.90
2A6	1.10	*6SR7	.75	32L7GT	1.60
3Q4	1.10	*6SS7	.67	35/51	.67
3Q5GT	1.10	*6ST7	1.10	35A5	.90
3S4	1.10	6US/6GS	.90	35B5	.90
3V4	1.10	6U7G	.67	35L6GT	.67
*5T4	1.32	*6V6	1.32	35W4	.57
5U4G	.67	6V6GT	.75	35Z3	.90
5V4G	1.10	6X5GT	.67	35Z4GT	.55
5W4GT	.62	6Y6G	1.10	35Z5GT	.57
5X4G	.75	7A4	.90	36	.67
5Y3GT	.47	7A5	.90	37	.57
5Y4G	.52	7A7	.90	38	.67
5Z3	.75	7A7	.90	39/44	.67
*5Z4	.90	7A8	.90	41	.57
6A6	.10	7B5	.90	42	.57
6A7	.67	7B6	.90	43	.90
*6A8	.90	7B7	.90	45	.55
*6AB7/1853	1.32	7B8	.96	45Z3	.75
6AC5GT	.90	7C5	.90	45Z5GT	.75
*6AC7/1852	1.32	7C8	.90	46	1.10
6AD7G	1.10	7C7	.90	47	.75
6AF6G	1.10	7C8	.90	50B5	.90
6AG5	1.60	7E5	.90	50L6GT	.75
*6AG7	1.60	7E6	.90	50Y6GT	.75
6AK5	.90	7E7	1.10	53	1.10
6AL5	.90	7F7	1.10	55	.75
6AQ5	.90	7F8	1.32	56	.55
6AQ7GT	1.10	7G7/1232	1.32	57	.62
6AT6	.75	7H7	1.32	70L7GT	1.95
6B4G	1.32	7J7	1.32	71A	.62
6B7	.90	7K7	1.32	75	.57
*6B8	1.32	7L7	1.32	76	.62
6BA6	.90	7N7	1.32	77	.62
6BE6	.90	7Q7	.90	78	.62
6C4	.75	7V7	1.60	80	.47
*6C5	.75	7Y4	.90	81	1.32
6C6	.67	*12A6	1.32	82	.90
6C8G	1.10	12A8GT	.67	83	.90
6D6	.67	12AT6	.75	84/6Z4	.75
6D8G	1.10	12BA6	.90	85	.62
6E5	.75	12BE6	.90	89	.27
*6F6	.75	*12C8	1.32	117L7/M7GT	1.95
6F8G	.90	*12H6	.75	117N7GT	1.60
6G6G	.90	12J5GT	.67	117P7GT	1.60
*6H6	.75	12J7GT	.75	117Z6GT	1.10

*—Metal Types

*—Metal Types

*—Metal Types



V.H.F. TRANSMITTER

Here is one of the greatest offerings in war surplus! Hundreds sold at 20 and new closed out at an amazingly low price. Brand new. Battery operated (67 1/2 v B and 1 1/2 v A). Frequency 80 to 105 mc. Complete with 2-1G4 tubes and full instruction manual. Ready to go on the air.

Less batteries \$6.95

All items F.O.B., Washington, D. C. All orders \$30.00 or less cash with order. Above \$30.00, 25 per cent with order balance C.O.D. Foreign orders cash with all orders plus exchange rate.

Hot Radio Values AT SUN RADIO

100 WATT BENDIX TRANSMITTER TA12



CHECK THESE VALUES: Three 807 Tubes, four 12SK7, one 2 inch 5 amp. RF meter, four Separate Master oscillators. (These can be easily changed to cover 20-40-80 meters and by using crystal for the 10 meter band you will have a complete coverage transmitter.)

Four separate output tanks. One 4 position selector channel switch having seven sections which changes the ECO, IPA and output tanks simultaneously. All the controls are mounted on the front panel. The housing is cast aluminum; shields and case are sheet aluminum. Dimensions 11 x 12 x 15 inches, weighing 35 1/4 lbs. Complete, simple instructions for version furnished. Complete with tubes \$49.95



SUPERHETERODYNE RECEIVER

This crystal fixed frequency receiver comes with full conversion instruction for variable tuning of all ham bands and broadcast. A highly selective superheterodyne receiver, 110 V.A.C. power supply built in. Using the following tubes: 6K7-RF Amplifier; 6K8 Mixer and Oscillator; 6K7 I.F. Amplifier; 6F7—Detector and A.V.C.; 6C8 Output and Noise Suppressor; 80 Rectifier. Dimensions—3 1/2 x 19 x 11 1/2 inches. Comes complete, brand new, with one set of coils and two sets of tubes \$16.95

Extra set of coils \$1.95

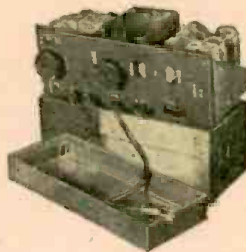

HAM AND POLICE SUPERHET TUNER

Brand New. Complete with 7V7 (1 Stage T.R.F.), 7O7 (1st IF & Osc.), 7V7 (2nd IF), 7F7 (Audio) and 7V7 (BFO). Frequency 2.4 to 16.3 mc. Filament voltage required 6.3 AC or DC -2.1 amp. Plate voltage required 135V DC-30MA. Only 4 1/2 x 9 1/2 x 3 3/4" and weighs only 6 1/2 lbs. Ideal for Ham and Police \$14.95



G.I. PORTABLE WINDUP PHONOGRAPH

A high quality, sturdily built, full toned windup phono originally built for armed forces as morale phono. Special triple spring motor plays 3 records on 1 winding. Speed adjustable from 33-78 revs. Brand new packed with 100 multiple play needles \$19.95

MICROPHONE

\$1.79

Brand new single button carbon hand mike by "Shure" with push to talk switch.



D.C. MILLIAMMETER

Brand new General Electric 2" round panel meters 0-300.



\$2.97



AUTOMATIC RECORD PLAYER

Including Webster No. 50 changer, three tube amplifier, 5" Alnico V Speaker in a deluxe leatherette case. List \$57.50

YOUR COST \$31.95



VM RECORD CHANGER

Brand New. Mixes 10 and 12" records.

\$16.95

Wood Base for above \$3.49

SUN RADIO

OF WASHINGTON, D. C.

938 F STREET, N. W. WASH. 4, D. C.

NEW
Hand-Size
LABORATORY



Model 666HH
VOLT-OHM-MILLIAMMETER

Here it is! The NEW "hand-size" Triplet tester that packs a laboratory of versatile service into a size that fits your hand and weighs only 1½ pounds. It's the tester you've been looking for.

In a handsome, streamlined, molded case, Model 666HH features greater scale readability; low contact resistance at jacks achieved by new banana-type plug-in leads; greater stability evolved through special new type resistors—these are just a few of the many refinements.

Model 666HH is an engineered marvel of compactness, a miniature "laboratory" that delivers more accurate, precise results per square inch than many kinds of larger, more costly equipment.

See, try, compare the brilliant performance of this thorough-going example of dependable Triplet engineering. It's the ideal tester for radio servicemen, radio amateurs, industrial engineers and laboratory technicians.

RANGES

D.C. VOLTS: 0-10-50-250-1000-5000, at 1000 ohms-Volt.

A.C. VOLTS: 0-10-50-250-1000-5000, at 1000 ohms-Volt.

D.C. MILLIAMPERES: 0-10-100-500, at 250 millivolts.

OHMS: 0-2000-400,000.

For Descriptive Material Write Dept. L-107

Precision first
...to last

Triplet



ELECTRICAL INSTRUMENT CO. BLUFFTON, OHIO

FORGE AHEAD IN RADIO

with the aid of these

3 GREAT BOOKS

"U.H.F. SIMPLIFIED"

"F.M. SIMPLIFIED"

"TELEVISION SIMPLIFIED"

by

MILTON S. KIVER

Associate Instructor of Radio,
Army Air Forces

Not a wasted word—not a complicated phrase—just an enlightening, fast-reading, well-organized collection of basic facts in this

MODERN RADIO LIBRARY!

Now, for the first time, available on a money-saving combination offer!

This complete library of present-day radio enables you to cash in on the tremendous possibilities that exist in this highly lucrative field. In each book the author breaks down a typical receiver into its individual parts, explaining in simple English the construction and purpose of each element of equipment and the part it plays in the operation of the set. There are complete directions for installing, trouble shooting and repairing every type of equipment. Hundreds of vivid illustrations show every detail of construction and operation. Every method, every circuit is made crystal clear.

These three great books are indispensable in your shop or library; they form a natural, closely related family of facts that work hand in hand to lead you to greater success in radio.

For free examination of this three-volume library of modern radio mail the coupon below.

INSPECT THESE REMARKABLE BOOKS AT OUR EXPENSE!

MAIL THIS COUPON

D. VAN NOSTRAND COMPANY, INC.
250 Fourth Ave., New York 3, N. Y.

Please send me, for free examination, the MODERN RADIO LIBRARY. Within 10 days I will return the books or send you \$4.95, followed by three monthly payments of \$3.00 each. (If you send \$13.95 within ten days we will pay postage.)

NAME

ADDRESS

CITYZONE ...STATE

RC-Oct. 1947

New Radio-Electronic Patents

By I. QUEEN

H.F. BAKING APPARATUS

Vernon W. Sherman, Summit, N. J.
(assignor to Federal Tel. & Radio Corp.)
Patent No. 2,413,003

When high-frequency heating is used to bake or toast, it is found that the outer surface of the food product does not form the usual crust. This is due to the fact that heating of a substance depends upon the dielectric properties and since

the dough is uniform throughout it is heated to the same degree.

From the standpoint of appearance and handling, it is desirable that the cake, bread, or other food product form an outer crust as usual. This can be accomplished by adding electrodes made of glass, plastic, or similar material. These have dielectric properties which cause them to be heated more than the dough products placed between the electrodes. The dough surface which contacts them receives more heat directly from the electrodes and consequently the desired crust forms.

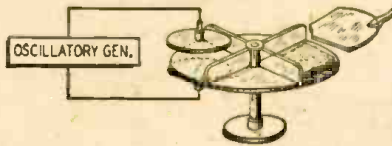

FREQUENCY MULTIPLIER

Jan A. Rajchman, Philadelphia, Pa.
Patent No. 2,405,519

It is very difficult to obtain a frequency multiplication factor greater than 2 or 4 in conventional electronic circuits. The invention described here discloses a means of obtaining a very high multiplication ratio so that very high frequencies are obtained from crystal-controlled oscillators.

arrangements are conventional except that the fundamental frequency supplies to the two sets of deflecting plates are 90 degrees out of phase but of the same frequency. Such an arrangement results in a continuous circular sweep of the electron beam. In passing through the perforated disc A the beam is interrupted. The three electrostatic-focusing plates then deflect the beam so that it passes through a cavity resonator B which is tuned to the desired high frequency. As each pulse of electrons passes through the cavity, the latter is set into oscillation, and the output is obtained at C. The electrons are collected at a plate and are returned to the tube cathode.

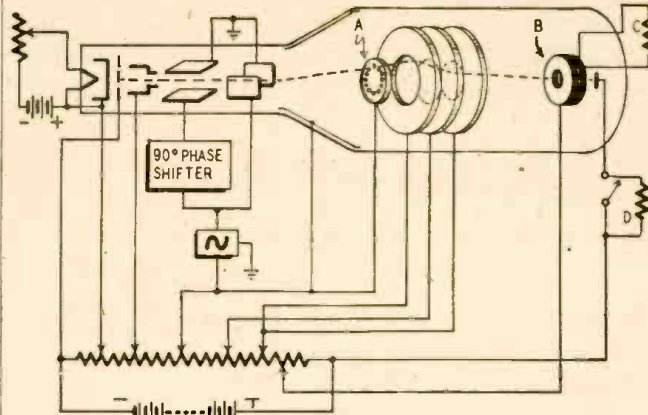

A special cathode-ray tube is used as shown in the figure. The beam-forming and focusing ar-

to the deflecting plates and passing the beam through a plate provided with 100 apertures.

This circuit can be used to obtain a stabilized frequency of 10,000 mc by applying 100 mc and passing the beam

THERMISTOR FM TRANSMITTER

William G. Shepherd
(Assigned to Bell Telephone Laboratories)
Patent No. 2,407,293

One of the difficulties of FM transmission is that of providing sufficiently large modulation swings without using a number of frequency multipliers. This inventor successfully uses a thermistor to achieve the desired result. The basic circuit includes two vacuum tubes coupled by a double-T network. Among the properties of the network are: suppression of a single frequency (determined by its R-C constants) and change of phase on either side of this frequency.

In order to generate oscillations, the output of the second tube must be in phase with the input to the first. The two tubes themselves account for 360-degree phase shift, and the output R-C network is adjusted for 70 degrees. Therefore the circuit oscillates at whichever frequency corresponds to a phase shift of 290 degrees within the network. Since the only variable is the thermistor, its resistance controls the frequency of oscillation.

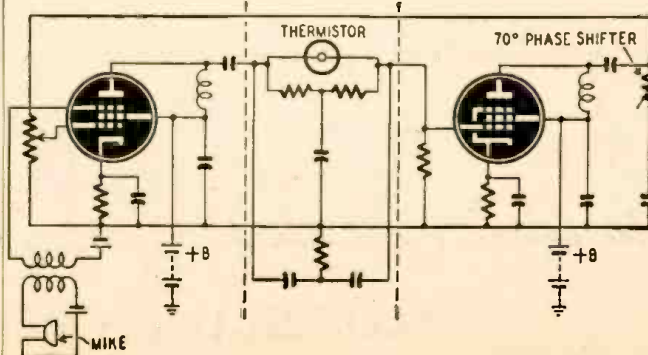

In an FM transmitter, the frequency varies with the strength of modulating signal. In this case, the audio is delivered to the suppressor of the first tube, and the output actuates the thermistor. The resistance of the thermistor changes with its temperature, and in turn, with the current flowing through it. Therefore the instantaneous frequency depends upon the sound level at that instant.



Use my 19 years of
Radio Experience
To Double Your Earning
Cut Servicing Time in 1/2

**30 LECTURES
COMPLETE \$3.00
ONLY**

GET ahead in radio servicing by using ideas and tricks of an expert. Add years of valuable experience to your present radio knowledge. Improve your servicing ability double-quick; avoid costly mistakes. Use this new giant 3-in-1 lecture-

manual of practical facts, time-saving hints, hundreds of circuits, suggestions, "know-how" tips, and explanations. Lick the hard cases in a jiffy. Find the cause of every puzzling radio defect. Use M. N. Beitman's 19 years of successful radio experience to your own advantage.

BOOK ONE

BUSINESS SIDE OF RADIO SERVICING

Four complete lectures by M. N. Beitman. Discussion of radio service problems. Opening and operating a radio store and shop. Selecting the right location. Store arrangement. Tested advertising ideas that cost little—bring big results. Window display suggestions. Service department. Model shop. What to charge. Bookkeeping and records.

SOLVES ALL ADVANCED SERVICING PROBLEMS

Let these lectures show you how to improve your store or shop, how to obtain free advertising for your business, what to charge, and how to keep records. Down-to-earth practical help on the business side of radio. Many lectures describing circuits, operation, and application of modern radio test equipment of every type. Meters, volt-ohmmeters, vacuum tube voltmeters, tube testers, analyzers, signal generators, oscilloscopes, signal tracers, condenser testers, Q-meters. Testers of R.C.A., Supreme, Weston, Radio City, Superior, Meissner, Feiler, Bliley, and others completely described. Also fourteen lectures on radio circuits and advance trouble-shooting. See list of topics at left. Material on television. Frequency modulation lecture originally delivered by Westinghouse engineers.

BOOK TWO

EQUIPMENT USED FOR LOCATING FAULTS

Visual and aural time-saving methods. Meters, volt-ohm-milliameters, related circuits. Vacuum tube voltmeters. Voltage and resistance point-to-point servicing. Tube testers (emission, leakage, dynamic, and mutual conductance types). Using a signal generator. Cathode ray oscilloscope as a servicing tool. Tuned signal tracers. Simplified signal tracing technique. Condenser testers. Bridges. Advanced test equipment. Twelve illustrated lectures on all modern test equipment.

KNOWLEDGE TO PUT YOU ABOVE COMPETITION

Complex and unusual radio faults may waste hours of your valuable time. The author has foreseen all possible problems (above the elementary level) and provided explanations and practical solutions in this unique on-the-job manual. Keep it on your work bench to aid and guide you on tough repairs. Use the thousands of hints and advanced servicing suggestions to speed up routine jobs. No other training book or course can compare to this new manual. Published in September, 1947. Be first to use it and forge ahead of others. Learn to do complicated repairs in minutes instead of hours.

BOOK THREE

RADIO CIRCUITS AND TROUBLE-SHOOTING INCLUDING TELEVISION AND F.M.

Fourteen easy-to-follow lectures on radio testing and making repairs. Tests for audio voltage and power amplifiers. Audio corrective circuits. Inverse feed-back. Phase inverters. Understanding impedance. Loud-speakers and output transformer matching. Function and adjustment of tuned circuits (a non-mathematical treatment for servicemen). Detector and AVC circuits. Troubles in R.F. and I.F. stages. Superhet converters and alignment hints. Power supplies; A.C., A.C.-D.C. and doubler types. Television facts. F.M. fundamentals and receiver description. Trouble-shooting and alignment in F.M. receivers. All 30 lectures of all 3 books, only \$3.00, see top of next column for more details.

LECTURE-COURSE WORTH \$60 YOURS FOR ONLY \$3.

Think what it would have cost you to attend in person the 30 lectures completely printed in *Advanced Radio Servicing* manual. Perhaps \$60, maybe even more figuring carfare. But in this giant volume you have every word of all lectures, plus illustrations of every slide used, and many additional photographs and charts. And the special bargain price for the complete 30 lectures in the giant manual, as shown at the top of page, is only \$3.00, full price. Take advantage of this remarkable bargain and secure on "no-risk" trial this practical radio training that will add years to your own experience. Send coupon today. Examine and use material for 10 days under our "satisfaction or money-back" guarantee.

Guarantee
We guarantee you complete satisfaction or will refund your total remittance.
SUPREME PUBLICATIONS

RADIO SERVICING COURSE-BOOK

A Companion Manual for Those Needing More Help Here is your fundamental radio training and review course. 22 lessons on radio servicing essentials. Covers every radio topic, just like a \$150.00 correspondence course. Pictures, drawings make text simple to follow and easy to apply. With self-testing questions plus index. Large size: 8 1/2 x 11 in., 224 pages 8th edition. Complete 22 lessons, plus supplementary data, price postpaid only **\$2.50**



NO RISK TRIAL ORDER COUPON

SUPREME PUBLICATIONS, 9 S. Kedzie Ave., Chicago 12, ILL.

Please send manual checked. You guarantee satisfaction or will refund my total remittance.

Advanced Radio Servicing, \$3.00 Radio Servicing Course, \$2.50
New, 3-volumes-in-one manual Elementary Companion Volume

I am enclosing \$....., send postpaid.
 Send C.O.D. I am enclosing \$..... deposit.

Name:

Address:

City: State:

Supreme Publications
PUBLISHERS OF RADIO BOOKS, MANUALS, AND DIAGRAMS

See Your Radio Jobber or Send Coupon →

BRAND NEW BC 348 COMMUNICATIONS RECEIVER

Featuring coverage from 200 to 500 Kc. and 1500 to 18,000 Kc on a direct reading dial with the finest vernier drive to be found on any radio at any price—high sensitivity with a high degree of stability—crystal filter—BFO with pitch control—standard 6 volt tubes. Contains a plate supply dynamotor in a compartment within the black crackle finished cabinet, the removal of the dynamotor leaves plenty of room for the installation of a 110V, 25 or 60 cycle power supply. These receivers, which make any civilian communications receiver priced under \$200.00 look cheap and shabby by comparison, are only \$69.95 brand new. Power supply kit for conversion to 110V 25 or 60 cycles, is only \$8.50 additional.

RT1463 7 tube amplifiers containing 3-7F7, 1-7Y4, 3-7N7, 4 potentiometers, numerous resistors, filter and bypass condensers, filter chokes, power and audio transformers, and six sensitive plate relays. A military development that provided amazing stepless control proportional to correction required, for ailerons, rudder and elevator, in the original application. A control amplifier of the ordinary type would deflect the rudder by some arbitrary amount when the ship was blown off the course to port or starboard. The result would either be that the correction was insufficient and the plane continued off course, or the correction would be too great, starting a series of tacks that would greatly increase fuel consumption and elapsed time in reaching the objective. This phenomenal unit, with its 3 amplifiers and six 5000 ohm relays in bridge circuits, will accurately control any 3 operations, related or unrelated, in minutely adjustable uniquely quantitative variations in either forward or reverse directions. 9"x7"x8" black crackle aluminum case. Brand new in original carton \$12.95, or used \$9.95.

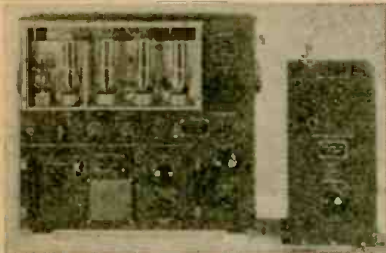

**GENERAL ELECTRIC
150 WATT
TRANSMITTER**

**Cost the Government \$1800.00
Cost to you \$44.50!!!!**

This is the famous transmitter used in U.S. Army bombers and ground stations, during the war. Its design and construction have been proved in service, under all kinds of

conditions, all over the world. The entire frequency range is covered by means of plug-in tuning units which are included. Each tuning unit has its own oscillator and power amplifier coils and condensers, and antenna tuning circuits—all designed to operate at top efficiency within its particular frequency range. Transmitter and accessories are finished in black crackle, and the milliammeter, voltmeter, and RF ammeter are mounted on the front panel. Here are the specifications: **FREQUENCY RANGE:** 200 to 500 KC and 1500 to 12,500 KC. (Will operate on 10 and 20 meter band with slight modification). **OSCILLATOR:** Self-excited, thermo compensated, and hand calibrated. **POWER AMPLIFIER:** Neutralized class "C" stage, using 211 tube, and equipped with antenna coupling circuit which matches practically any length antenna. **MODULATOR:** Class "B"—uses two 211 tubes. **POWER SUPPLY:** Supplied complete with dynamotor which furnishes 1000V at 350 MA. Complete instructions are furnished to operate set from 110V AC. **SIZE:** 21 1/2 x 23 x 9 1/4 inches. Total shipping weight 200 lbs., complete with all tubes, dynamotor power supply, five tuning units, antenna tuning unit and the essential plugs. These units have been removed from unused aircraft but are guaranteed to be in perfect condition.

**GENERAL ELECTRIC RT-1248 15-TUBE
TRANSMITTER-RECEIVER**

TERRIFIC POWER—(20 watts) on any two instantly selected, easily pre-adjusted frequencies from 435 to 500 Mc. Transmitter uses 5 tubes including a Western Electric 316 A as final. Receiver uses 10 tubes including 955's, as first detector and oscillator, and 3-7H7's as IF's, with 4 slug-tuned 40 Mc. IF transformers, plus a 7H7, 7E6's and 7F7's. In addition unit contains 8 relays designed to operate any sort of external equipment when actuated by a received signal from a similar set elsewhere. Originally designed for 12 volt operation, power supply is not included, as it is a cinch for any amateur to connect this unit for 110V AC, using any supply capable of 400V DC at 135 MA. The ideal unit for use in mobile or stationary service in the Citizen's Radio Telephone Band where no license is necessary. Instructions and diagrams supplied for running the RT-1248 transmitter on either code or voice, in AM or FM transmission or reception, for use as a mobile public address system, as an 80 to 110 Mc. FM broadcast receiver, as a Facsimile transmitter or receiver, as an amateur television transmitter or receiver, for remote control relay hook-ups, for Geiger-Mueller counter applications. It sells for only \$29.95 or two for \$53.90. If desired for marine or mobile use, the dynamotor which will work on either 12 or 24V DC and supply all power for the set is only \$15.00 additional.

BC 654 TRANSMITTER RECEIVER—This medium power transmitter and the very sensitive receiver is a natural for 80 meter operation (phone or cw). These units are brand new and come complete with 17 tubes, key, microphone and 200 KC calibrating crystal—\$39.95.

BC-947A ONE KILOWATT HIGH FREQUENCY TRANSMITTER

This relay-controlled transmitter includes a 115V, 60 cycle power supply, protected by 3 magnetic circuit breakers, that alone is worth more than the price we are asking for the whole rig, even on today's surplus market. On the front panel are six 3 1/2" GE or Weston meters, including 250 MA, 50 MA, 1000 MA, 150V AC, and 1500V DC at 1000 ohms per volt for screens and plate. The rack-type 21"x15"x36" unit contains six amplifier and rectifier tubes aggregating over \$60.00 at WAA current wholesale prices. Western Electric's price to the government was \$1500.00. Shipping weight 500 lbs. Your cost, as is, only \$69.95.

ARMY BC-312 COMMUNICATIONS RECEIVER

This receiver covers the frequency range of 1.5 MC to 18 MC in six direct reading bands. The dial, that is driven with split gears to prevent backlash, has 4500 logging divisions per band with approximately 600 divisions on the 20 and 40 meter ham bands and 1000 divisions on 80 meters. Two stages of RF before the converter in this set give it a very high signal to noise ratio and maximum sensitivity. Outstanding features of this receiver are: BFO with pitch control, send-receiver relay, jacks on the front panel for headphones and speaker output, and mike and key input. All tubes are standard 6 volt types. This receiver was designed to withstand rough usage in the field and for operation from vehicles while in motion, so it is ruggedly constructed and contains a dynamotor power supply—Your cost—\$49.95. Conversion kit to 110 VAC is available for ... \$6.50

Minimum order \$3.00 — All prices subject to change — 25% deposit with COD orders

SERVICEMEN

Check This Column for Lowest Prices on Quality Parts

TUBES: all types in stock, 60% off on all tubes if ordered in lots of 10 or more.

TRANSFORMERS—All types in stock. **AUTO-TRANSFORMERS:** Steps up 110v to 220v, or steps down 220v to 110v—\$1.95. **FIL. TRANS.:** 6.3v, 8 Amps.—\$1.98; 5v, 10 Amps.—\$1.96; Universal Output Trans. 8 Watt—89c; 18 Watt—\$1.29; 30 Watt \$1.69. **AUDIO TRANSFORMERS:** S. Plate to S. Grid. 3:1—79c; S. Plate to P.P. Grids—79c; Heavy Duty Class AB or B. P.P. Inputs—\$1.49; Midset Output for AC-DC sets—69c; **MIKE TRANSFORMER** for T-17 Shure microphone, similar to UTC oncuer type—\$2.00. Stancor SB or DB mike to line or grid—\$1.95.

POWER TRANSFORMERS—Half-shell type, 110V, 60 cy, Centertapped HV winding. Specify either 2.5 or 6.3V filament when ordering.

For 4-5 tube sets—650V, 40MA, 5V & 2.5 or 6.3V.....\$1.49
For 5-6 tube sets—650V, 45MA, 5V & 2.5 or 6.3V.....1.75
For 6-7 tube sets—675V, 50MA, 5V & 2.5 or 6.3V.....1.90
For 7-8 tube sets—700V, 70MA, 5V & 3 or two 2.5V.....2.35
For 8-9 tube sets—700V-90MA, 5V-3A, 2.5V-3.5A, 2.5-10.5A.....2.85
For 9-11 tube sets—700V, 100MA, 5V & 6.3V-4A.....2.85
For 9-15 tube sets—600V, 150MA, 5V & 6.3V.....2.95

CONDENSERS—PAPER TUBULAR 600 WV—.001, .002, .005—8c; .01, .05—9c; .1—10c; .25—23c; .5—36c; **ELECTROLYTICS:** 8mfd 200v—20c; 10mfd 35v—20c; 30mfd 150v—23c; 20/20mfd 150v—35c; 30/30 150v—46c; 50mfd 150v—43c; 8mfd 475v—34c; 16mfd 350v—45c; **OIL CONDENSERS:** 4mfd 600v 49c; **BATH TUB TYPE CONDENSERS:** 3X1mfd—20c; **RESISTORS:** All types in stock at the lowest prices; Resistor Kits; 100 2 watt resistors—\$1.95.

FILTER CHOKES: 200, 300, 400, 500 ohm light duty—59c; 200 or 300 ohm heavy duty—99c; 250 ma 35 ohm, made for U.S. Navy, fully shielded—\$1.95; 75 ohm 125 ma—25c or 25 for \$4.25; "Meissner type" tapped filter chokes—25c; 8 amp. iron core A filter—25c; Choke-condenser combination. Ideal to replace any size speaker field when installing PM speakers—79c.

110 V. CIRCUIT BREAKERS of Magnetic type: Following Current Ratings in Stock; 1.25, 3, 4, 8 Amps. Please specify. \$1.95 each.

Seven Assorted I.F. Transformers—\$1.98; Five Assd. Oscillator Coils—69c.

SPEAKERS—PM dynamic type—4"—\$1.55; 5" \$1.55; 6"—\$1.95; 8"—\$3.95; 10"—\$5.95; 12"—\$7.50.

HEADPHONES—Highest quality Signal Corps headsets with 12" cord and plug \$1.25. 5' rubber covered patchcords with phone plug and socket—45c.

SELENIUM RECTIFIERS—Dry disc type 1 1/4" by 1" 1.2 Amp. maximum, suitable for converting DC relays to AC, for supplying filament source in portable radios, converting DC meters to AC applications, and also may be used in low current chargers—80c.

METER RECTIFIERS—Full wave, may be used for replacement, or in construction of all types of test equipment—\$1.25. Half Wave—90c.

LINE FILTERS — Each unit contains two 2 mfd. oil filled condensers and a 15 amp. iron core choke. This filter has innumerable uses such as oil burner line filter, etc. A ten dollar value for 98c.

FLOUORESCENT LIGHT BALLASTS, Single 30 or 40 watt. \$1.68; Dual 40 watt, \$3.50.

WILLARD rechargeable 2v storage batteries for portable radios or any other purpose—\$2.95.

PUBLIC ADDRESS AMPLIFIERS—25 watts peak output. This unit has separate input circuits for microphone and phono. The gain of the microphone circuit is 122db. The phono circuit has a gain of 82db. The frequency response is flat from 50 to 12,000 cycles. A \$65 value for only \$32.

Miniature filters set contains one of each of the following: Needle nose, flat nose, parrot nose, standard nose. All contained in a leatherette case. Your cost—\$1.98.

ATR battery eliminator—Handy for servicing car radios or any other purpose requiring 6 or 12v at 14 amps. Net price—\$36.

SOCKET WRENCH SET consisting of 5 sockets ranging in size from 5/16 to 1/2" and a handle—79c.

AUTOMATIC WIRE STRIPPERS will strip up to 1000 wires per hour, a handy tool for any service job—\$3.52.

Six Foot Asbestos Insulated Flat Iron Cord, one end has a male plug, the other end has a standard flat iron socket. Your price—70c each or 10 for \$5.

FREE!!!! THIS MONTH ONLY

A HIGH GRADE CRYSTAL PICK-UP WITH THE PURCHASE OF EACH PHONO MOTOR AT \$4.95.



MICROPHONES—All nationally known brands. Bullet crystal—\$5.45; Bullet Dynamic—\$7.45; Mike Jr.—60c; Handy Mike—90c; Lapel Mike—93c; SHURE T-17 MIKES, with push to talk switch—99c.

20 ASS'D COIL FORMS, including 11 ceramic, 3 polystyrene, and 6 fiber, all useful sizes—85c.

VARIABLE CONDENSERS: 350 MMFD, 5 gang—\$1.95; 4 gang—\$1.49; 3 gang—83c; 2 gang—79c; 7.5 to 20 MMFD, 1750v spacing, extra long shaft Hammarlund—65c; miniature variables, 25 MMFD—39c; 50 MMFD—49c; 75 MMFD—59c; 100 MMFD—69c; 140 MMFD—79c.

TRANSMITTING RF CHOKES, 4 PIE, 350 Ma.—25c or 5 for \$1.00.

INTERRUPTION FREQUENCY COILS for super-regenerative receivers or the tremendously popular FM adapters for standard broadcast sets. Iron core with a resonant frequency of 50 KC—39c; Air Core, 100 KC—29c.

30 MC IF TRANSFORMERS, double slug tuned—25c.

VIDEO AMPLIFIER PLATE—Slug tuned—25c.

REMOTE CONTROL UNIT: Aluminum case 4x3x2" containing 2 potentiometers, triple pole switch, 4 knobs, gear mechanism, counter and phone jacks—59c.

MODULATION TRANSFORMERS—30 watt, open-type, \$1.95 40 watt, cast aluminum case, \$2.95; Class "B" input transformers, cast aluminum case, \$1.95; Transceiver audio transformers, 65c; Transceiver modulation transformers, 65c.

RADIOMEN'S HEADQUARTERS — WORLD WIDE MAIL ORDER SERVICE !!!

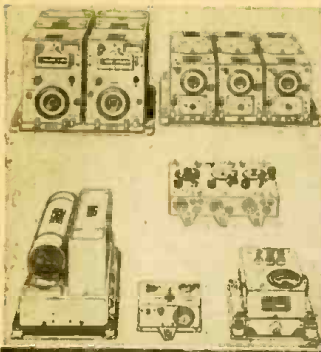

SCR-274N COMMAND SET

The greatest radio equipment value in history

A mountain of valuable equipment that includes 3 receivers covering 190 to 550 KC; 3 to 6 MC; and 6 to 9.1 MC. These receivers use plug-in coils, and consequently can be changed to any frequencies desired without conversion. Also included are two Tuning Control Boxes; 1 Antenna Coupling Box; four 28 V. Dynamotors (easily converted to 110 V. operation); two 40-Watt Transmitters including crystals, and Preamplifier and Modulator. 29 tubes supplied in all. Only a limited quantity available, so get your order in fast. Removed from unused aircraft and in guaranteed electrical condition. A super value at \$29.95, including crank type tuning knobs for receivers.

PE-109 32-VOLT DIRECT CURRENT POWER PLANT

This power plant consists of a gasoline engine that is direct coupled to a 2000 watt 32 volt DC generator. This unit is ideal for use in locations that are not serviced by commercial power or to run many of the surplus items that require 28-32 V. D. C. for operation. The price of this power plant is only \$100. We can also supply a converter that will supply 110v AC from the above unit or from any 28-32v DC source for \$29.95.

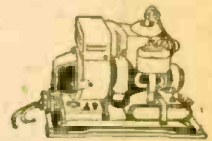

LORAN INDICATOR OSCILLOSCOPE, complete with 26 tubes and a 5" cathode ray tube, government instruction manual included—\$39.95.
5" SO RADAR PPI OSCILLOSCOPE, complete with 9 tubes. This unit contains magnetic deflection yokes and a Selsyn motor—\$39.95. **SO RADAR ECHO BOXES, THE PERFECT CALIBRATED CAVITY WAVEMETER**—\$10.00.

Range Unit RT-1579 consists of a three stage high gain, high fidelity amplifier and a Helmholtz coil for manually introducing phase shift from 0° to 360°. The amplifier is cascade 6SJ7 driving a 6F6 in the output, also on the same chassis is the 110v 60 cycle power supply. The Helmholtz coil is rotated by a vernier drive mechanism which has a dial that contains 4000 ¼ inch divisions. Your cost—\$14.95.

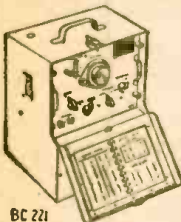

RAYTHEON VOLTAGE REGULATOR, will maintain a constant 115 V AC at the load even though the input voltage varies from 95 to 130 volts. The regulation is ½ of 1% with a 75 watt load. Shipping weight 20 pounds. Your cost \$8.95.

SCR-610 TRANSMITTER-RECEIVER ready to operate on 19 meter phone by connecting it to 6, 12 or 24 VDC—\$49.95.

Relay Box BC-616 contains 3 high speed DPDT DC relays, that may be used as keying relays, resistors and a 150 MFD condenser. The aluminum box, with cover, measures 5½x6½x2 inches. While this terrific bargain lasts—\$1.95.

BC 221 FREQUENCY METERS with calibrating Crystal and calibration charts. A precision frequency standard that is useful for innumerable applications for laboratory technician service man, amateur, and experimenter, at the give-away price of only \$39.95.

RECO-PLAY, the Sensational Record Maker



RECO-PLAY is an outstanding triple feature recorder. It includes a powerful public address system with crystal microphone, a quality phonograph, and most important of all, a recorder capable of putting a radio program, a hit tune from a regular record, office dictation, or a barber shop quartet, on any record blank. RECO-PLAY's recordings can be played on the newest phonographs as well as the oldest; so that junior's latest baby talk can be mailed to grandma in Grand Rapids, where she can play it back on the old wind-up victrola that has been in the parlor since before World War I. This feature gives RECO-PLAY a terrific advantage over some of the recorders on the market that require such specialized playback equipment that they, in effect, limit the recording to use on the machine that produced it. We recommend this machine for schools, police departments, offices and home use. In drama and voice training and perfecting delivery of speeches and sermons, the purchase of one of these patented \$69.95 recorders will make available the services of your most exacting critic—yourself. Hear yourself as others hear you, and secure a profit on your investment within a few days by making records for others.

INTRODUCTORY OFFERING OF OUR OWN BRAND CAR RADIO ANTENNAS

All of our car radio antennas are made of triple plated Admiralty Brass Tubing, complete with low loss shielded antenna leads and have high quality fittings.

SIDE COWL—BR-1, 3 sections extend to 66". Your price—single units—\$1.50; in lots of 12—\$1.35 ea.
SKYSCRAPER—BR-2 has 4 heavy duty sections that extend to 98". Your price—single units—\$2.45; in lots of 12—\$2.25 ea.

TILT ANGLE—BR-3, may be adjusted to all body contours. 3 sections extend to 66". Single unit price \$1.50; 12 lot price—\$1.25 ea.

VERSATILE—BR-4, single hole fender or top cowl mounting may be adjusted to conform with all body contours. 4 sections extend to 66". Single unit price—\$2.90; 12 lot price—\$2.75 ea.

THE MONARCH—BR-5, single hole top cowl mounting, sections extend to 56". Single unit price—\$1.90; 12 lot price—\$1.75 ea.

BENDIX SCR 522—Very High Frequency-Voice Transmitter-Receiver—100 to 156 MC. This job was good enough for the Joint Command to make it standard equipment in everything that flew, even though each set cost the Gov't. \$2500.00. Crystal Controlled and Amplitude Modulated—HIGH TRANS-MITTER OUTPUT and 3 Microvolt Receiver Sensitivity gave good communication up to 180 miles at high altitude. Receiver has ten tubes and transmitter has seven tubes, including two 832's. Furnished complete with 17 tubes, remote control unit, 4 crystals, 24 volt dynamotor and the special, wide band VHF antenna that was designed for this set. These sets have been removed from unused aircraft and are guaranteed to be in perfect condition. We include free parts and diagrams for the conversion to continuously variable frequency coverage in the receiver. The cost of this unit is only \$37.95. Brand new 12 volt dynamotor for SCR 522—\$12.00. Used SCR 522, less dynamotor, remote control unit and antenna—as-is—\$19.95.

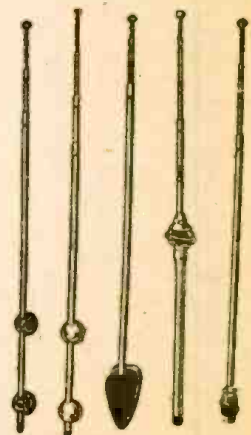

BR1 BR2 BR3 BR4 BR5

Minimum order \$3.00 - - - All prices subject to change - - - 25% deposit with C.O.D. orders

BUFFALO RADIO SUPPLY, 219-221 Genesee St.; Dept.10C, BUFFALO 3, N. Y.

Cable Address: BUFRAD

Learn to Service and Repair all Kinds of ELECTRIC MOTORS



Get into the busiest, most profitable end of electrical servicing.

A "NATURAL" FOR ALERT RADIO MEN!

With only a little radio experience, it should be a cinch for you to qualify as a motor repair expert! **ELECTRIC MOTOR REPAIR**—the big 570-page course by the publishers of famous Ghirardi Radio-Electronic Books—can train you rapidly, at home, in spare time for only \$5 complete! It's written clearly and simply. Beginners can easily understand it. Every step is explained in text as well as VISUALLY by more than 900 step-by-step illustrations. It tells you exactly what to do—exactly how to do it. Best of all, it covers practically every type of motor in common use. These include both a-c and d-c motors, synchronous motors and generators AND both mechanical and electrical motor control systems.

There's Real Business Here!

The average small home has 11 motors. Big homes have many more—in phonographs, recorders, oil burners, refrigerators, fans, clocks, mixers, washers, cleaners, etc. Millions more in office and industrial equipment. Be the well-paid expert who can repair them! Now, for the first time in vocational history, you can train for this profitable work quickly at home!

SPECIALIZE IN SOMETHING DIFFERENT

The real "cream" of the electrical service business is in motor repair. Most home appliances and industrial machines are motor driven. Good motor repair men are scarce—and are paid accordingly. It's a real opportunity—and **ELECTRIC MOTOR REPAIR** helps you cash in on every phase of it from minor repairs to complete armature rewinding.

TRY IT FOR 5 FULL DAYS

Practice from **ELECTRIC MOTOR REPAIR** for 5 full days. Repair motors for yourself or friends. Earn while you learn! Then, if not more than satisfied this is the book for you, return it and your money will be refunded at once. You cannot lose! Send coupon NOW!

YOU CAN'T LOSE ON THIS OFFER

Dept. RC-107, Murray Hill Books, Inc., 232 Madison Ave., New York 16, N. Y.

Send me a copy of "ELECTRIC MOTOR REPAIR" for which I enclose \$5 (\$3.50 foreign) or I send C.O.D. for this amount and I will pay postman \$5 plus postal charge when he delivers it to me. If this book is not what I need, I'll return it within 5 days and you guarantee to refund my \$5.

Name

Address

City & Zone State

PLOUGHING BY RADIO

(Continued from page 21)

frequency oscillators, the outputs of which were applied to the modulator valves either singly or together by switching the tone oscillator outputs.

The transmitter, as previously stated, may be any ordinary amplitude-modulated master-oscillator type. The actual transmitter used in the test was a Bendix Model TA-12B aircraft equipment together with a type MP-28B power supply which included the modulator.

The receiver was a superheterodyne, and care had been taken to ensure that little distortion of the audio tone was present. This was assured by the use of delayed automatic gain control applied to the mixer and 1 of the 2 intermediate-frequency amplifiers only; thus, non-linear amplification or modulation rise was to a large extent avoided. Post-detector automatic gain control was used to keep the output voltage constant for all values of input above the automatic gain control delay voltage.

The output of the radio receiver was connected to 2 tubes in parallel in whose anode circuits were connected 2 relays X1 and X2. The grid circuit of each tube consisted fundamentally of a resonant circuit whose resonant frequency corresponded to the tone frequency. A rectifier was connected across each filter. The valves were normally in a non-conducting condition so that when no anode current is flowing the relays will not be operated. The circuit appears in Fig. 3.

On the arrival of a tone, or both tones, each filter had applied to it either or both of these tones, but only the desired tone was accepted. The rectified output of the filter was applied to the grid of the relay tube and thus set up conditions which produced anode current and so operated the relay (or relays).

The control circuit actuated by the receiver relays is shown in full in Figs. 1 and 2.

Some Illustrations

To give a clearer idea of the tractor and its control equipment 2 close-up views are shown.

The complete experimental equipment can be seen in the photos: transmitting set in the foreground, and the tractor running with plough raised in the background. The items of control equipment on the tractor itself are as follows:

1. The receiver, with flexible rod aerial;
2. The turn-selector relay box on the left of the receivers;
3. To the right of the receiver, and in the following order, are the main relay box, the throttle control unit, and the directional control unit;
4. Behind the above items can be seen the batteries and the compressed-air (high-pressure) bottle and reducing valve. In both photographs the large plough-raising ram servometer is clearly visible.

Speaking purely from the technical viewpoint, the ability to control a tractor, or for that matter simultaneous (Continued on page 64)

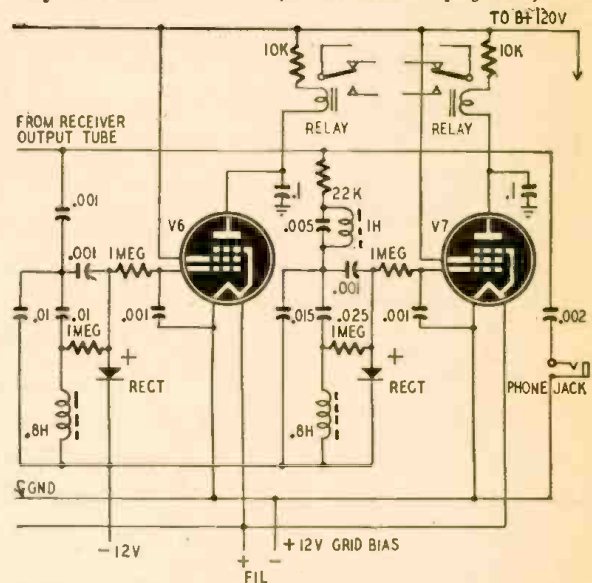

Fig. 3—Receiver's output stage shows resonant circuits and relays.

LCETI

SEE PAGE 8

HERE IT IS!

PRACTICAL AMPLIFIER MANUAL

45 circuits for the technician, service man and experimenter. Home recorders, phono oscillators, intercom systems.

Price \$2.00 Check or P.O. Orders
OSTRONIC PUBLICATIONS
196 W. 37th Pl. Los Angeles 7, Calif.



NOW *Sound* FOR YOUR SILENT PROJECTOR Economically

\$5995

Convert your 16mm silent projector to sound (regardless of make) with Apex sound head & radiofilm adapter. Guaranteed excellent performance. Write today for free information.

APEX VIDEO • 12209U Branford St. • Roscoe, Calif.

RADIO & ELECTRONIC BARGAINS

- 250 ass'd coded RESISTORS 1/2, 1, 2W; pop sizes \$4.95
- No. Mx11 50 ass'd MICAS pop sizes mkd or coded 1.95
- No. Mx12 21 Transmitting Micras .0003 to .02, 600 & 1200 WVDC Solar XCB or Micamold (3 ea size) Mx13 2.25
- TRANSFORMER, hi Voltage, 1200 V 12 ma 110v 50-60 c in No. T31 2.25
- Hundreds of other bargains also KITS designed by ROBERT G. HERZOG.

Write for free data, circuits & lists.
UNIVERSAL GENERAL CORP.
365R Canal Street, New York 13, Walker 5-9642



DON'T LET OTHERS PUT YOU OUT OF THE PICTURE!

Here's How CREI Home Study Training Prepares You NOW to do a BETTER Job and Enjoy a Secure Career in Radio-Electronics Servicing

CREI Courses for Every Serviceman Keep You Ahead of Competition—Earn You More! Never before have so many men like you had the opportunity to step ahead in the many specialized fields of modern radio servicing. Men with up-to-date technical training are needed in every branch of radio-electronics. That's because radio's maintenance manpower has not kept pace with radio's technical development.

What are you doing to meet this need for highly skilled electronics service technicians and engineers. You must improve your technical knowledge to qualify for maintenance and service work in this new broadened service field. CREI offers you a proved program of technical self improvement that you can study in your spare time, at home. The same type of practical, down-to-earth training for which thousands have enrolled since 1927.

Remember, too, there's a CREI course for you. No matter what your radio experience—CREI offers complete training in radio-electronics for any man who wants to improve his ability and his chances for advancement. You can "go all the way with CREI" from introductory basic principles to advanced training and on to specialized engineering subjects.

Read our 24-page booklet and a free sample CREI lesson . . . then judge for yourself. There is no obligation. You are already started in this field. Find out how you can rapidly prepare to advance beyond your present level. Send the coupon NOW!

VETERANS! CREI TRAINING AVAILABLE UNDER THE "G. I." BILL!

Capitol Radio Engineering Institute

An Accredited Technical Institute

DEPT. RC-10, 16TH AND PARK ROAD, N. W., WASHINGTON 10, D. C.

Branch Offices: New York (7): 170 Broadway • San Francisco (2): 760 Market St.

SAMPLE LESSON **FREE**

Now, see for yourself! Mail the coupon for free sample lesson and see how simple it is to study at home and improve your ability the CREI way.

"ELECTRON PHYSICS AND ELECTRON THEORY"—This interesting lesson from the Radio-Electronics course discusses modern theories of the composition of matter, including *atomic energy*, and their relation to present-day radio and electronics.

"PICK-UP TUBES—ICONOSCOPE AND IMAGE DISSECTOR TUBES"—An informative lesson from the Television course. These are the fundamental pick-up tubes of the television camera. It precedes the study of the Orthicon and the Image Orthicon.

MAIL COUPON FOR FREE BOOKLET & SAMPLE LESSON



CAPITOL RADIO ENGINEERING INSTITUTE

16th & Park Rd., N.W., Dept. RC-10, Washington 10, D. C.

Mail me ONE FREE sample lesson and your 24-page booklet, "CREI Training for Your Better Job in Radio Electronics". I am attaching a brief resume of my radio experience, education and present position.

Check One PRACTICAL RADIO-ELECTRONICS
Course: PRACTICAL TELEVISION

NAME _____

STREET _____

CITY _____ ZONE _____ STATE _____

I am entitled to training under the "G. I." Bill.

TRANSVISION SCOOP!

NEW! SENSATIONAL! 12" TELEVISION KIT by TRANSVISION It's TOPS IN TELEVISION VALUE!

1 1/2 TIMES BIGGER PICTURE THAN WITH 10 INCH TUBE

Engineered for easy rapid assembly. Completely equipped. Nothing else to buy.

12" STANDARD and DELUXE MODELS . . . Have BIG 75 sq. inch Picture! Sharp, steady picture achieved with advanced Transvision television circuit. Picture has remarkable brightness even in lighted room.

• NO TECHNICAL KNOWLEDGE REQUIRED FOR ASSEMBLY.

• SAVE HUNDREDS OF DOLLARS—By assembling your own television receiver set.

• IDEAL for HOME and COMMERCIAL use.

12" TRANSVISION TELEVISION KIT . . . Standard Model . . . Picture size 1 1/4 times larger than with 10" tube . . . RF Unit designed for 13 channels; factory wired and pre-tuned for 7 channels; no areas have been assigned more than 7 channels; however if desired, up to 6 more channels may be added at very nominal cost . . . 6 mc bandwidth for full picture definition . . . High fidelity FM sound reproduction . . . picture size 75 square inches . . . 9000 volts second anode potential for brightness and contrast . . . maximum picture sensitivity better than 50 microvolts . . . 22 tubes and 12" picture tube . . . LIST \$289.00

12" TRANSVISION TELEVISION KIT . . . Deluxe Model . . . with Super Built-in FM RADIO . . . Same characteristics as the Standard Model, plus the following ADDITIONAL FEATURES:—50-210 mc continuous tuning . . . Covers the entire FM band and all 13 television channels . . . Cut-off switch eliminates unused tubes when set is used only as FM receiver . . . LIST \$359.50

TRANSVISION TELEVISION CABINETS . . . Beautiful, sturdily built cabinets with handsome rubbed wood finish. Fully drilled. 12" Table Model Cabinet . . . List \$44.95

12" Console Cabinet with compartment for record changer . . . List \$74.50

See your local distributor, or for further information write to:

TRANSVISION INC., Dept. R.C., 385 North Ave., New Rochelle, N. Y.



WORLD-WIDE STATION LIST

(Continued from page 40)

15.210	KGEI	SAN FRANCISCO, CALIFORNIA: Guam-Philippine beam, 0400 to 0900
15.220	JTL3	TOKYO, JAPAN: 1800 to 0230
15.230	VLG6	MELBOURNE, AUSTRALIA: 2100 to 2300
15.230	MOSCOW, U.S.S.R.:	2200 to 2400; 0530 to 0830; 0015 to 0930; 1030 to 1330
15.250	WLWK	CINCINNATI, OHIO: European beam, 1430 to 1630; South American-Central American beam, 1700 to 0100
15.270	WCBN	NEW YORK CITY: European beam, 0600 to 1645
15.270	WCRC	NEW YORK CITY: South American beam, 1700 to 2300
15.280	WNRE	NEW YORK CITY: European beam, 0500 to 1815
15.260	GSI	LONDON, ENGLAND: 0400 to 0430; 1030 to 1400
15.290	KWIX	SAN FRANCISCO, CALIFORNIA: Japanese-Chinese beam, 1730 to 2200
15.290	WRUL	BOSTON, MASSACHUSETTS: European beam, 0600 to 1400
15.290	VU03	DELHI, INDIA: 2245 to 0030; 0130 to 0345; 0200 to 0400; 0445 to 0815
15.300	GWR	LONDON, ENGLAND: 0600 to 0900; 1045 to 1380; 1400 to 1430; 1700 to 1800
15.310	GSP	LONDON, ENGLAND: 2345 to 0030; 0100 to 0500; 0600 to 0815; 1200 to 1315; 1815 to 1845
15.310	VLC4	SHEPPARTON, AUSTRALIA: 2045 to 2145; 0010 to 0045; 1730 to 1800; 1900 to 1915; 2200 to 2225
15.310	HER6	BERNE, SWITZERLAND: Saturdays, 1000 to 1200
15.320	MOSCOW, U.S.S.R.:	2200 to 2300; 0000 to 0500; 0530 to 0800; 0830 to 1100
15.330	WGEO	SCHENECTADY, NEW YORK: European beam, 0600 to 1645
15.330	KNBX	DIXON, CALIFORNIA: South American beam, 1700 to 2200; Japanese-Chinese beam, 2215 to 0345
15.340	MOSCOW, U.S.S.R.:	2200 to 0800; 1000 to 1100
15.350	WRUS	BOSTON, MASSACHUSETTS: European beam, 0500 to 0715; 1030 to 1815; Mexican beam, 1830 to 0100
15.350	WRUA	PARIS, FRANCE: 0700 to 0900
15.350	WRUA	BOSTON, MASSACHUSETTS: North African beam, 0500 to 0745; 1030 to 1815; Central American beam, 1830 to 0100
15.450	GRD	LONDON, ENGLAND: 0100 to 0500; 0600 to 0700; 1700 to 1845
15.590	FZ1	BRAZZAVILLE, FRENCH EQUATORIAL AFRICA: 0445 to 0800; 0930 to 1030
17.440	HVJ	VATICAN CITY: 0715 to 0845
17.530	FZ1	BRAZZAVILLE, FRENCH EQUATORIAL AFRICA: 0000 to 0130; 0445 to 0745; 1100 to 1700
17.700	GVP	LONDON, ENGLAND: 0600 to 1115; 1200 to 1600
17.710	GRA	LONDON, ENGLAND: 0600 to 0815
17.730	GVQ	LONDON, ENGLAND: 0100 to 0500; 0800 to 1215
17.750	WRUW	BOSTON, MASSACHUSETTS: European beam, 0600 to 1400; Caribbean beam, 1715 to 1745
17.760	KWID	SAN FRANCISCO, CALIFORNIA: South American beam, 1600 to 2300
17.760	PARIS, FRANCE:	0700 to 0900; 1100 to 1230
17.770	OTC	LEOPOLDVILLE, BELGIAN CONGO: 0500 to 0930; 1130 to 1645
17.770	WDOV	NEW YORK CITY: European beam, 1700 to 1815
17.780	WNBI	NEW YORK CITY: European beam, 0500 to 1830; South American beam, 1645 to 2300
17.780	KCBR	DELANO, CALIFORNIA: Japanese-Chinese beam, 2330 to 0345
17.790	GSG	LONDON, ENGLAND: 0500 to 1030

See CANNON-BALL HEARING AID for Radio Reception



Easily attached to any Radio for private reception with or without loud speaker. Write

C. F. CANNON CO.
SPRINGWATER, N. Y.

Headset Headquarters

GREYLOCK RADIO TUBES

All GT, Glass, and Miniature Types.

List Price each, up to \$1.00	Your Cost, each 29c
List Price each, up to \$2.00	Your Cost, each 39c
List Price each, over \$2.00	Your Cost, each 49c

All Tubes carry RMA 90-Day Guarantee

PM SPEAKERS

4" Alnico #5	each \$1.19
5" Alnico #5	each 1.29

TERMS: Not COD. No order accepted for less than \$5.00

WRITE FOR BARGAIN CATALOG

GREYLOCK ELECTRONIC SUPPLY CO.

30 Church Street New York 7, N. Y.

TUBULAR ELECTROLYTICS

Fresh stock Fully guaranteed

20 mfd. 150 V.	10 for \$1.79
20-20 mfd. 150 V.	10 for 2.49
8 mfd. 450 V.	10 for 1.85

Postage extra 25% deposit on COD. Write for our free bargain lists featuring "AMERICA'S BEST BUYS"

POTTER RADIO CO.

1312-1314 McGee St. Kansas City 6, Mo.

BE YOUR OWN BOSS!

MAKE MORE MONEY



\$1.00 VALUE

25c

40,000 WORDS IN TEXT

NO ADS ALL "MEAT!"

Money Back Guarantee

NATIONAL PLANS COMPANY

Box 26RA, Ansonia Station New York 23, N. Y.

In "CASH IN" you now get THE real money-makers—dozens of profitable tested mail order plans, confidential business secrets, dozens of practical tested formulas, successful tested schemes—actual experiences of men who have started on a shoe-string—with less than \$10 capital. 25c a copy postpaid. Send U. S. stamps, money order, or coin.

ROTA-BASE

NEW MANDY LAB. DIAL actually gives a "prong" picture of radio tube connections. Simply turn the dial to the tube number desired on the ROTA-BASE and complete correct connections are instantly indicated on the "prong" diagram. No more valuable time lost thumbing pages or on lengthy readings. Filament, grid, plate, cathode, etc. to MORE THAN 300 tube types are given. PRICE NOW ONLY \$1.00 postpaid or sent C.O.D. plus postage. Order NOW, money refunded if you are not delightfully pleased.

REED MFG. CO. 412 S. Main St. Los Angeles 13, Calif.

PEN-OSCIL-LITE

Extremely convenient test oscillator for all radio servicing; alignment • Small as a pen • Self powered • Range from 700 cycles audio to over 600 megacycles u.h.f. • Output from zero to 125 v. • Low in cost • Used by Signal Corps • Write for information.

GENERAL TEST EQUIPMENT

38 Argyle Ave. Buffalo 9, N. Y.

RADIO-CRAFT needs more photos of service shops and service benches. We will pay \$6.00 for each 6x8- or 8x10-inch glossy photo accepted. Do not "dress up" your bench, but take a bona-fide photo, preferably with men working.

OLD TUBE TESTER

(Continued from page 36)

Then $R = E/I$, or $3/0.004 = 750$ ohms. 750 minus the 600 in the instrument equals 150 ohms. Thus, 150 ohms was placed above the 4-milliamper mark and other calibrations were made accordingly.

In use, as shown in Photo 6, a jumper lead is connected from terminals 1 to 5 and test leads placed in jacks 2 and 6, with probes on the ends of these leads across the resistor under test. In this test the meter indicated somewhat below the 2-milliamper mark. Transferred to the cardboard scale as in the photo this would mean around 1,000 ohms.

While these readings may not be as accurate as those taken on a precision meter, a tester such as this one will find many uses as an auxiliary unit in checking radios and appliances.



ESSE Specials!

UNLESS OTHERWISE SPECIFIED, MERCHANDISE HAS BEEN REMOVED FROM SURPLUS AIRCRAFT AND IS SOLD AS USED

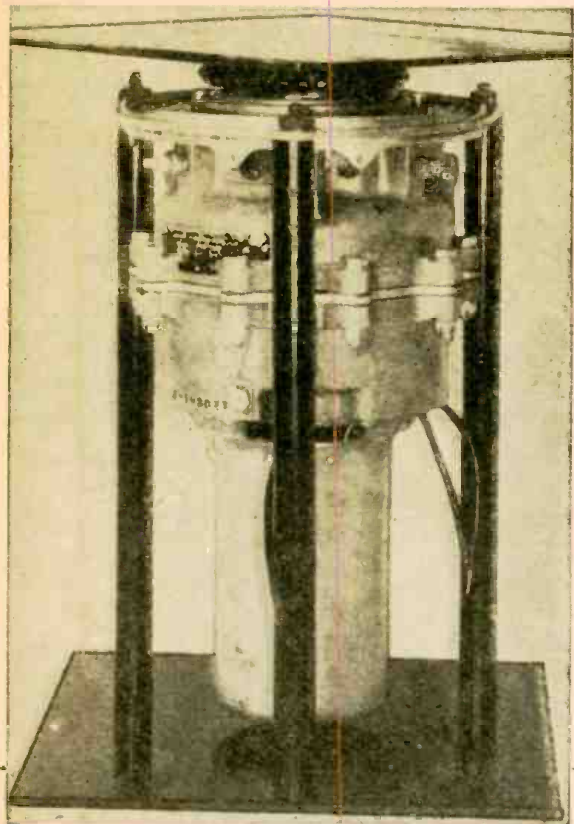

BEAM ROTATING MOTOR - CONVERTED

Shown Above

Operates from 20-35 V. AC or DC. Motor 1/3 H.P. reversible with 7,000:1 gear reduction ratio. Speed approximately 1 revolution per minute. Has heavy thrust bearing, permitting heavy weights to be borne directly. Motors are removed from electric propellers of surplus aircraft.

Price **\$21⁷⁵**

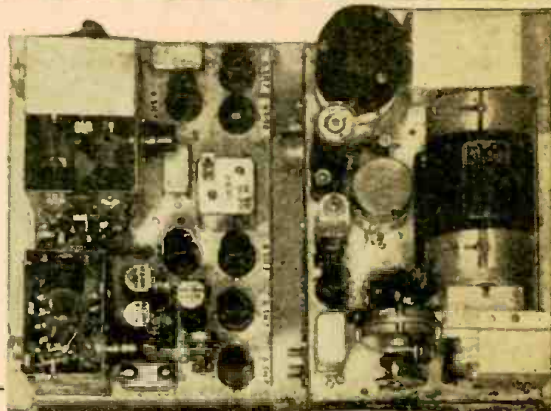

BC-966-A IFF. - Price \$4⁷⁵

Contains following: Pioneer Gen-E-Motor, 18 V. input, 450 V. 60 Ma. Output; 65W-40 ohm resistor; 1 Mfd. 1000 V. condenser; 4-lo-current relays 4-7193, 7-6SH7, 3-6H6; Eclipse Carbon pile type voltage regulator, etc. May be converted for Citizens band operation or 2 meter operation.

BC-357 MARKER BEACON RECEIVERS

Ideal for controlling remote circuits for model aircraft, boats, etc. Operates from 75 mc. Signal easily altered to 2 meter band. Tubes used and included; 1-6SH7, 1-6SL7GT, 1-12SN7GT. Also sensitive relay. Circuit diagram included inside case. Size 5 1/2" x 3 3/4" x 5 3/4". For 24 V DC operation. Complete as shown.

Sold in Carton Lots Only.
6 Per Carton. Price..... **\$1⁹⁵** ea.

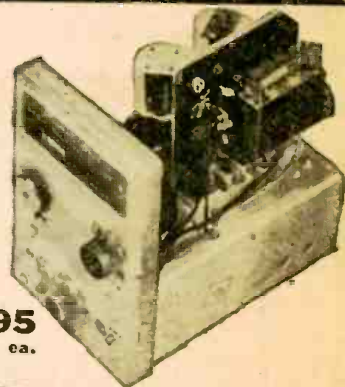

TURBO AMPLIFIERS

Used for parts or small phono amplifier—chipped complete with the following tubes: 2-7C5's, 1-7Y4, 1-7F4.

SOLD IN CARTON LOTS ONLY. 10 PER CARTON

.75^c ea.

**TERMS:
CASH WITH
ORDER**

ESSE Radio Company

130 W. New York St. - Indianapolis 4, Ind.

RADIOMEN! ELECTRICIANS!

240 Page BOOK on "HOW TO
START A SHOP
OF YOUR OWN"

FREE

Here's an unusual "get acquainted" offer!
This new 1947 book, "Starting and Operating a Profitable Electrical or Radio Business" is yours, absolutely FREE! It tells how to start and run a paying service shop right, on small capital, full or part time. Packed with practical information to help you get ahead in a shop of your own or working for some one else.

10 to 1 Satisfaction GUARANTEE

"I personally guarantee that at the end of 1 year from date of receipt, my 'Applied Practical Radio' set will have earned for you at least 10 times its cost, or you may return it and I'll return every cent you paid."

B. W. Cooke, Pres.



HOW TO GET YOUR FREE BOOK

You get this book Free just for looking over — without cost or obligation—the sensational new 3-volume Coyne set "APPLIED PRACTICAL RADIO". It's just off the press. Here's everything you want to know about radio, from basic principles to up-to-the-minute Television and

FM! PA, short-wave, aviation-auto radio, multi-bands, tele-transmission, etc., all clearly explained. Shows how to construct, install, service all types of apparatus. Step-by-step photos break equipment down before your eyes! Newest testing methods. Hundreds of subjects, almost 1000 pages, 600 illustrations, diagrams. Written for home training and field reference—so complete, so up-to-date and practical that every man interested in radio should see it.

SEND NO MONEY You can see how much this set can mean to your future, without cost or obligation. I'll send "APPLIED PRACTICAL RADIO" postpaid, for you to look over for 7 days FREE—and with it, the "Business Starting" book as an outright Gift! This book is yours to keep free whether or not you decide to keep the 3-VOLUME SET!

**Coupon is Not an Order
Just a Request to
See the Set Free**

YOU ARE NOT BUYING THE 3-VOLUME SET WHEN YOU SEND THIS COUPON. You are merely asking to see the books free for 7 days. This coupon becomes an order only if you decide to keep the set after 7 days' Free Examination. Free Book Offer is limited — so mail coupon today.

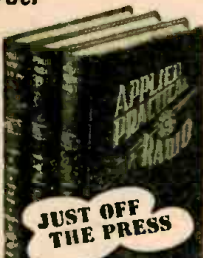

**JUST OFF
THE PRESS**

FREE BOOK COUPON

B. W. Cooke, Pres., COYNE ELECTRICAL SCHOOL
Dept. 77-T, 500 S. Paulina St., Chicago 12, Illinois

Send me the NEW 3-Volume Coyne Set "APPLIED PRACTICAL RADIO". Also send me the book "Starting and Operating a Profitable Radio or Electrical Business", which I am to keep FREE whether or not I keep the 3-book Set. I'll either return the 3-book Set in 7 days and owe nothing, or pay \$3 within 7 days and \$3 a month until \$10.75 is paid—or I'll send the cash price of \$9.75. You also include FREE one full year of Consultation Service.

NAME AGE.....

ADDRESS

TOWN ZONE..... STATE.....

Check here if you want to pay postman cash price of \$9.75 (you save \$1.00) on delivery. Same Money-Back Guarantee after 7 days' trial.

PLASTIC CABINET (Continued from page 26)

cooling is less than 1/32 inch, although the plastic acts rubbery when soft.

The humped back was straightened with the homemade clamp arrangement shown in Photo 5; it is crude but effective—2 parallel pieces of wood with a nut and bolt provided the pressure.

Nothing could be done to repair the torn leatheroid on the door without going to the trouble of recovering the entire door, so it was merely glued smooth to prevent further fraying. The torn leatheroid can be reglued with any model-airplane or speaker cement. Apply carefully in the correct amount, and only to the surfaces to be bonded. The acetone solvent in this cement will dissolve the surface of the leatheroid.

Non-plastic repairs

A new handle was made from an old camera handle. However, any strip of leather will do. Simply cut to proper



Photo 7—The cabinet looks almost like new.

width and length, and have a shoemaker sew or rivet an overlap at each end.

A new latch was made from a small piece of spring brass, 4 bolts, and 2 nuts. A piece 1½ x 1¼ inches was cut, and 4 holes were drilled near each of the corners. Corresponding holes were drilled in the straightened cabinet. The old latch was removed, and the strip placed equidistant across the top of the two halves of the cabinet. See Photo 6. Nuts and bolts are used to fasten the new latch to the front half of the cabinet, while bolts are soldered in the other 2 holes. The bolts are then filed slightly to remove their threads. The natural spring of the brass keeps the 2 bolts in their holes and the halves of the cabinet together. To open, pull up the strip of

OPPORTUNITY AD-LETS

Advertisements in this section cost 20 cents a word for each insertion. Name, address and initials must be included at the above rate. Cash should accompany all classified advertisements unless placed by an accredited advertising agency. No advertisement for less than ten words accepted. Ten percent discount six issues, twenty percent for twelve issues. Objectionable or misleading advertisements not accepted. Advertisements for November, 1947, issue must reach us not later than September 27, 1947. Radio-Craft = 26 W. 87th St. • New York 7, N. Y.

CORRESPONDENCE COURSES AND SELF-INSTRUCTION books slightly used. Sold, Rented, Exchanged. All subjects. Satisfaction guaranteed. Cash paid for used courses. Complete information and 100-page illustrated bargain catalog Free! Write—Nelson Co., Dept. 39, Chicago 5, Ill.

MAGAZINES (BACK DATED)—FOREIGN, DOMESTIC arts, books, booklets, subscriptions, pin-ups, etc. Catalog 10c (refunded). Clerone's, 863 First Ave., New York 17, N. Y.

FREE WHOLESALE BULLETIN, TUBES, PARTS Bargain prices. Henshaw Radio Supply, 3313 Delaware City, Kansas City, Kansas.

AMATEUR RADIO LICENSES, COMPLETE CODE and theory preparation for passing amateur radio examinations. Home study and resident courses. American Radio Institute, 101 West 63rd Street, New York City. See our ad on page 88.

WE REPAIR ALL TYPES OF ELECTRICAL INSTRUMENTS, tube checkers and analyzers, Hazelton Instrument Co. (Electric Meter Laboratory), 140 Liberty Street, New York, N. Y. Telephone—Barclay 7-4239.

RADIOMEN, SERVICEMEN, BEGINNERS—MAKE more money easily. \$250 weekly possible. We show you information free. Merit, 216-321, 132nd Avenue, Springfield Gardens 15, New York, New York.

WRITE DEPT. RC 20 FOR OUR LATEST FREE BARGAIN list of Radio and Electronic parts. R.C. Radio Parts and Dist. Co., 733 Central Ave., Kansas City 6, Kansas.

FOR SALE—FIRST NINE RIDER'S MANUALS, NEW. \$100. OVID HELM, Box 326, Ironton, Ohio.

AVAILABLE NOW A NEW FM KIT 7 TUBES WITH frequency response of 86-110 MC, completely self contained receiver. The RF section is pretuned at the factory. 2 I.F. stages, 1 limiter stage and 1 discriminator. Miniature tubes used throughout. Price \$29.95. Special for the month... 10 inch television kit... Price \$124.50 less tubes. 7 inch television kit \$77.50 less tubes. Details forwarded on request. RADIO WHOLESALE SUPPLY CO., 120 Liberty St., New York, N. Y.

FCC LICENSE. HOW TO PREPARE FOR THEORY examination in four weeks. Method of study \$1. BOX 41, Steubenville, Ohio.

BUILD RADIO—KIT OF PARTS \$5.95. FM AND other kits. Circular. RYCO DISTRIBUTORS, P.O. Box 84, Ozone Park, N. Y.

TELEVISION RCVRs. (6-15"). PROJ. RCVRs. Cameras, Xmttrs., Serv. Engr. RF Power units, 2-60KV. —FM-AM. Revers.—compt. diag. 50c each. Kits upon request. PROGRESSIVE ELECTRONICS, P.O. Box 6382, Philadelphia 39, Pa.

TESTING EQUIPMENT, ALL TYPES AND MODELS. Expertly repaired and calibrated. Free estimates. METRO-POLITAN ELECTRONICS, 42 Warren St., N. Y. 7, N. Y.

25 YEARS EXPERIENCE RADIO REPAIRING AT your fingertips. I've perfected simple system you can follow step by step. Requires no formulas or calculations. Cuts repair time to minimum. Total price \$1.00 post paid or COD. Money-back guarantee. HORS RADIO COMPANY, 14615-J Grandriver, Detroit 27, Michigan.

AMBITIOUS. SELL XMAS CARDS. STATIONERY. Big profits. Colored Catalog Free. Beacon Hill Greetings, 115 Chauncy, B. Boston, Mass.

FOR SALE—COMBINATION TUBE TESTER, ANALYZER Multi-meter, Good Condition. WA 6-2077, New York City. 9 A.M.—3 P.M.

PRICES SLASHED—TERRIFIC BARGAINS—RADIO Supplies—Kits—Standard Tubes 60% discount—Free Bulletins—TECHNICAL LABORATORY—341 Wilson Ave. Brooklyn, N. Y.

BUILD YOUR OWN RADIOS, PHONOGRAPHS, AND Electronic Equipment. Send for our Free Gift Offer and Complete Catalogue. McGee Radio, 1330 Broadway, Denver, Colorado.

FOR SALE: HIGH SPEED PHOTO FLASH DE-scribed Feb. '47 RADIO-CRAFT, P. 22 Lyman Greenlee, 404 Madison, Anderson, Indiana.

brass. The finished job is shown in Photo 7.

Not all plastic cabinets will respond to this heat and pressure treatment, but the kind that warps usually does.

NOW YOU TOO CAN BUILD 15 RADIOS

COMPLETE
KIT ONLY

\$14.⁷⁵
00



ABSOLUTELY NO KNOWLEDGE OF RADIO NECESSARY YOU NEED NO ADDITIONAL PARTS!

THE PROGRESSIVE RADIO KIT is THE ONLY COMPLETE KIT. Contains everything you need. Instruction Book, Metal Chassis, Tubes, Condensers, Resistors and all Radio parts. The 36-Page Book written by Expert Radio Instructors teaches you to build radios in a Professional Manner. You start with two 1-tube receivers. Then you will build three 2-tube receivers. You will continue by building six 3-tube receivers. You will then make a 3-tube public address system which will permit you to address large audiences. Finally you will build three different 3-tube transmitters so that you can get a real thrill out of being "on the air." Before you are done with this kit, you will have built 11 Receivers, 1 Public Address System and 3 Transmitters.

RADIO PARTS

SCOOP!

NO SURPLUS — ALL PARTS
GUARANTEED BRAND NEW!

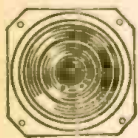

SPEAKERS
6-INCH PM ALNICO V
SPEAKERS

\$1.69

CONDENSERS

DUAL 20/20 MFD ELEC-
TROLYTIC CONDENSERS
150 V.D.C.

29c



COILS
MATCHED ANTENNA
AND RF COILS FOR
BROADCAST BAND
SET:

53c

RECTIFIERS

SELENIUM
RECTIFIERS

79c



SPECIAL FREE OFFER!

Electrical and Radio Tester sent absolutely FREE with each Progressive Radio Kit. PLUS FREE membership in Progressive Radio Club. Entitles you to free expert advice and consultation service with licensed radio technicians. Write for further information, or ORDER your KIT NOW!

MAIL COUPON TODAY!

PROGRESSIVE ELECTRONICS CO., Dept. FP-2
22 HAVEMEYER STREET, BROOKLYN 11, NEW YORK

SIRS: Please send me the following:

- Progressive Radio Kit Complete \$14.75
- 6" Alnico V Speakers (\$1.69 each)
- Electrolytic condensers (29c each)
- Sets Antenna & RF coils (53c per set)
- Selenium Rectifiers (79c each)
- Enclosed find check or money order (Postage Prepaid) TOTAL
- SEND C.O.D. (I will pay postage)

NAME

ADDRESS

CITY

ZONE

STATE

Send additional information on Radio Kit.

LEONARD'S

FALL PRICES

BEST VALUE HAZELTON

MULTI TESTER RANGES

AC Volt 0-1500
DC Volt 0-1500
DC Mills 0-150
Resistance 0-300,000

\$11.75



ELECTRONIC MEASUREMENTS VOLOMETERS

101A 3" METER **\$17.50** NET
Model 101B

OPEN FACE 4" METER **\$20.95** NET
OPEN FACE PORTABLE

101AP 3" Meter **\$21.50** net

101BP 4" Meter **\$24.95** net



NEW!

"PREMIER"

BANDSPREAD DIAL

SIGNAL GENERATOR \$54.75

Model 570



The "Premier" Model 570 is the ONLY low-priced Signal Generator with a MICROMASTER BAND-SPREAD DIAL, equivalent to a scale length of approx. 60"—a major feature for logging, sharp and critical tuning.

- AIR TRIMMERS ON ALL BANDS.
- TRIPLE COPPER PLATED SHIELDING.
- Range 75KC-50MC on fundamental, and 50-150MC on 3rd harmonic, useful for aligning FM and Television Receivers.
- Accuracy better than 1%.
- Special sealed straightline frequency tuning condenser provides linear calibration over entire dial range. Complete with co-axial cable.
- Overall size 12" by 12 1/2" by 5 1/2"; shpg. wt. 21 lbs.

RECORD CHANGERS

WEBSTER 56—Automatic Stop **\$26.66**

DETROLA **14.50**

SEEBURG—2 Post. **22.95**

RCA CRYSTAL MIKE **\$4.95**
with table stand

KENYON Power Transformer
325 mill—400 v. CT—6.3 at 4.5
amps. Fully shielded. 5 v. at 6 amps. **\$5.95**

6L6 Push Pull or Push Pull Parallel 50 watt.
Completely shielded. 250 mill primary 5000
ohms—sec. 2-4-8-15-500 ohms. **\$5.19**
H-57—Special Lim. Quan.

PHONO MOTOR and PICKUP KIT

SPECIAL **\$4.95**

Complete

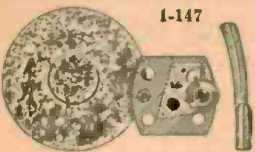

Crystal pick-up—Top quality constant speed motor. Motor Assembly only. **\$3.95**
Send 25¢ deposit with order—balance Express Collect. Orders under \$5.00 send check or money order plus postage.

LEONARD RADIO INC.
69 CORTLANDT ST.
NEW YORK 7, N.Y.

R.F. VOLUME CONTROL

In some high-gain audio amplifiers ordinary volume controls introduce objectionable noise into the circuit, and in all but a few cases a rotary motion must be used to operate it.

The electronic volume control shares neither of these disadvantages and lends itself with versatility to a number of unusual applications.

The basic principle of the control is placing a variable negative voltage upon the control grid of a variable-mu tube

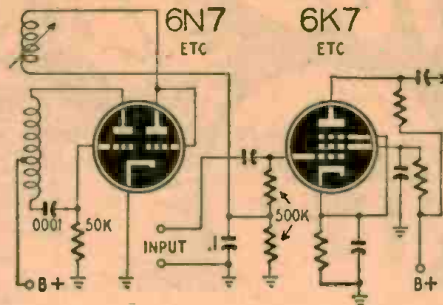

such as a 6D6, 6K7, or 7B7. This can be done readily (as shown in Fig. 1) with a radio-frequency oscillator variably coupled to a diode rectifier, the output of which controls the variable-mu tube.

In applications such as electronic musical instruments, where both hands are occupied, a foot pedal or similar installation may be arranged to vary coupling between the coils.

A very interesting application of the electronic volume control is in the remote control of radio or public address volume. The system consists of a small 1-tube radio-frequency oscillator as the remote control device and a 3- or 4-tube single-frequency receiver to supply the control voltage to the controlled device. A small superhet can be used if the a.v.c. is disconnected.—Glen Southworth.

NOW AVAILABLE! Full Range Reproduction



A revolutionary development in amplifiers cleverly designed to defy obsolescence and amazing in its performance. New circuits, new materials and new processes are actually combined in this one amplifier to produce the most satisfying musical amplifier the world has ever known. If you are one of those discriminating persons for whom anything less than the best is a disappointment, you are one for whom the ACA-100DC was designed. Send for technical literature.

AMPLIFIER CORP. of AMERICA

398-10 Broadway, New York 13, N. Y.

CONSTANT VOLTAGE STABILIZER, G.E. Cat. No. 69
G 30132, Input 103 to 127 volts 57 to 63 c.p.s.
Output caps 110, 115, 120 and 125 volts Volt.
Reg. plus over minus 1% at norm. freq., 800 V.A.,
7.7 Amps at 93 P.F. Dimensions 50x15x10 1/2"
Net wt. 280 lbs. @ \$59.50

TACHOMETER GENERATOR G.E. Type CM-5 Model
52-50

A.C. GEN. VOLTAGE REGULATOR, made for 7.5 KVA,
120 V, 60 cycle Gen., Field current 0.2 Amps.
Max regulated field resistance 700 ohms. With ex-
ternal variable 150 ohm resistor for independent
voltage settings. Ward Leonard type 5600. @ \$4.95
each Ten for \$39.50

FLUORESCENT TRANSFORMER, General Electric, 60 cycle
input, 2.5 volt 40 Amp. Output 100 KVA 3 KV.
Insulation. @ \$2.75 each Ten for \$17.50

STEP DOWN TRANSFORMER, Jefferson Electric, 115
volt 60 cycle primary 20 volt 10 Amp. secondary,
mounted in watertight box. @ \$3.95 each Ten
for \$30.00

VARIABLE CURRENT TRANSFORMER, Ward Leonard, Class, 20
ohms 4.05 Amps. Complete with all hardware
@ \$3.50 each Ten for \$29.50

INSULATION TESTER
0-200 and 0-200 megohms, full scale
0-5 and 0-5 Megohm, center scale

The original unit, The Weston Model 706 In-
sulation Tester operated at a 500 volt test poten-
tial supplied by eight 67 1/2 volt batteries. This
has been modified by us to utilize two 1 1/2 volt
standard No. 6 dry cells and a vibrator power
supply for the 500 volt test potential, thereby
eliminating the high replacement cost of batteries.
Enclosed in a hardwood carrying case 8 3/4"x9 1/2"x8".
The Weston Model 801, 3 1/2"x3 1/2"x2 1/2" 0-50
microampere meter, guarantees extreme accuracy
on all ranges.

Surplus—Now Guaranteed @ \$39.50 each
WESTON MODEL 706 In-Insulation Tester, Model
461, Type 4. This unit can be used with any pre-
cision 5 Ampere A.C. Meter to extend the ranges
of the meter to 50, 100, 200, 250, 500 or 1000
Amperes A.C. Accuracy within 1/2% of Normal
Secondary Capacity—15 VA; Binding Posts for 50
Ampere tap; Inserted primary for 100, 200, 250,
500 and 1000 Amps; Complete for use up to
2500 volts. List Price \$98.00; Only \$35.00 each.

METERS

Simpson, 25, Signal Strength ("S") Meter, 3 1/4" rd
fl bak case. Use this on the plate circuit of your
receiver to show the relative strength of incoming
signals. Sc calibrated—6 to 100 DB above 1 micro-
ampere 5 MA Zero right mvt. 100 ohm scale for
internal ac illumination from rear of meter. Comp
with socket, lamp and leads. For further details
refer to pages 164-166 and Fig. 730 B of
Amateur's Handbook **\$4.50**

Weston, 301, Type 21 Standard Decibel Meter, 3 1/4"
rd fl bak case, minus 10 to plus 8, 0.1 M.W., 600
ohms; General purpose type; 0-100 Second to final
reading, 45-62% overthrow. 5000 ohms internal
resistance at 0DB. Ideal for home recorders **\$8.50**

Voltage Polarity Phase Rotation Triplicat **\$7.25**

AVP, Checks 115, 220 and 440 line voltage; locates
open circuits, blown fuses, damaged wiring, etc.; In-
dicates whether A.C. or D.C., and polarity of D.C.;
Checks phase rotation to determine direction of rota-
tion of motors, operation of controls, etc.; Consists of
a 3" square meter and a small polarized vane move-
ment in small handy sized case. Complete for use up to
2500 volts with test prods. **\$8.50**

Time Totalizer Indicates up to 9,999.9 hours for
50 or 60 cycles operation 130 volts

Black scale 3" rd fl bakelite case, Clamp mount.
Made by Industrial Timer Corp. **\$4.00**

Weston 621 Output Meter, ranges 0-2,
0-10, 0-50 Volts Audio Frequency. Complete with 3"
lead with pin plugs and plug (PL 55) **\$7.80**

Weston 507, 750 MA, ac cal 10-10 Antenna Current
Indicator, comp with ext thermocouple, 2 1/2", rd fl
bak case, black scale **\$2.95**

Weston 507, 3 A, black scale, 2 1/2", rd fl bak case
with ext thermocouple, 2 1/2", rd fl bak case **\$3.50**

W.H., NT-35, 3 A, 3 1/2", rd fl bak case **\$5.50**

Weston 301, 500 V D.C., 1000 ohms per volt, 3 1/2"
rd fl bak case **\$9.50**

Weston 301, 3 1/2", 4 K.V., with external pre-
resistor **\$8.50**

G.E., DO-41, 2.5 KV, black sc, with 1000 ohms per
volt ext. wire wound resistor, 3 1/2", rd fl bak case
W.H., NX-35, 1.5 KV with 1000 ohms per volt, ext
prec wire wound resistor & mtg clips, 3 1/2", rd fl
bak case **\$7.25**

W. H., NX-35, 20 KV with ext prec wire wound 1000
ohms per volt resistor and mtg clips **\$21.00**

Simpson 25, 1 MA, 3 1/2", rd fl bak case **\$4.30**

Simpson 25, 15 MA, 2 1/2", rd fl bak case **\$4.50**

Simpson 25, 200 MA, 3 1/2", rd fl bak case **\$4.50**

G.E., DO-41, 200 microampere mvt, Knife edge
pointer, mtd "set Carrier" supp with paper
V.O.M.A. sc, 3 1/2", rd fl bak case **\$4.95**

Triplett, 100 ua mvt, 950 ohms resist, made for
666-9C Analyzer; sc cal in Volts, MA & Ohms, 3 1/2"
sq fl bak case **\$8.95**

Weston 476, 130 V, 3 1/2", rd fl bak case **\$4.95**

W. H., NA-35, 15 V, (100 MA) 3 1/2", rd fl bak
case **\$3.95**

W.H., NA-35, 150 V (10 MA) 3 1/2", rd fl bak
case **\$5.50**

Weston 476, 4A A.C. 3 1/2", rd fl bak case **\$4.95**

SPECIAL COMBINATION OFFER

A set of 8 useful meters which can be used to build
the following:

- RADIO CIRCUIT ANALYZER
- ELECTRO PLATING PANEL
- REPAIR SHOP TEST PANEL
- LIGHTING PLANT PANEL

A.C.-D.C. VOLTMETER Sterling 1" dia. Ring mtd.
stamped metal case polarized vane type. 250 Volts
5% Accuracy

A.C.-D.C. AMMETER Sterling 2" Sq. stamped metal
case, polarized vane type. 15 Amperes. 5% Accuracy

D.C. MILLIAMMETER G.E., DW-41, 2 1/2", rd fl bak
case, 1 MA mvt. Complete with paper Volt Ohm
Milliammeter scale. 2% Accuracy

D.C. AMMETER W.H., PI (NX-33) 2 1/2", rd fl bak
case. Black scale, 150 Amp. with ext. shunt,
2% Accuracy

D.C. VOLTMETER G.E., DW-51, 2 1/2", rd fl bak case,
black scale, 15 Volt, 2% Accuracy

AUTOMOTIVE AMMETER U.S., Gauge Co. 2" dia.
clamp mtd, polarized vane type, 30-0-30 Amp.
charge & discharge. 5% Accuracy

R.F. AMMETER G.E., DW-44 2 1/2", rd fl bak case;
black scale, 6 Amperes Radio Frequency. 2% Ac-
curacy

A.C. VOLTMETER G.E., AW-41, 2 1/2", rd fl bak case,
black scale, 15 Volts, 500 cycle accuracy within
2% on 800 cycle and 7% on 60 cycle.

SPECIAL OFFER \$9.25
ALL 8 METERS

All Prices Net, F.O.B., N.Y.—include sufficient postage; excess will be refunded. C.O.D.'s not sent unless accompanied by 25% deposit.

All items are Surplus-Now-Guaranteed. Orders accepted from radio clubs, schools, public institutions, etc., on open account.

The above is only a partial listing of the many items we have in stock. Send for free circular. MANUFACTURERS, EXPORTERS, DEALERS—We invite your inquiries.

MARITIME SWITCHBOARD

336A Canal Street New York 13, N. Y.
Worth 4-8217

Start Your Own RADIO SERVICE SHOP

Choose one of these 3 GREAT NEW DEALS

Includes TEST EQUIPMENT, TUBES, PARTS, TOOLS

3 complete going-in-business packages. (If necessary they can be changed to suit your needs.)

There never was a better opportunity than now to start a profitable business of your own. No fuss, no worry. Here's everything you need. Details upon request. Write, wire or phone!

\$99⁵⁰

\$179⁵⁰

\$350⁰⁰

Featherweight Miniature TEST INSTRUMENTS

Compact — Accurate — Priced Right!

- Jeweled Meter • Range Selector Switch
- All multipliers bridge tested for 1% accuracy
- Zero adjustment—built in batteries
- Molded bakelite case only 3-13/16" x 2-7/8" x 2"

MODEL 451A AC-DC Volt—Ohm—Milliammeter



A dependable instrument of wide utility—sensitivity 1000 ohms per volt. Ranges: Volts AC, DC, and Output Ranges, 0-10/50/100/500/1000; Ohms full scale, 500,000. Ohms center scale, 7200.

NET complete with Batteries

1490

MODEL 312 Volt—Ohm—Milliammeter



An economy pocket meter featuring a 2" moving vane meter. Reads: AC-DC volts, 0-25/50/125/250; Mills AC-DC, 0-50; Ohms, 100,000; mfd. .05-15. Jacks provide range selection.

NET Complete with cord and plug.

675

FAMOUS "LITTLE TRIPLETT'S"

The Little Testers with the big 3" Meters Bakelite cases 3 1/4" x 5 3/4" x 2 1/4" Range selection switch—long, easy to read scales. We made a good buy—here they are at rock-bottom prices—The greatest buy ever offered in precision testing equipment.

MULTI-RANGE MILLIAMMETERS

Two types—for A.C. or D.C. measurements

MODEL 671—for A.C. current. Seven switch selected ranges of 0-5, 10, 25, 100, 250, 500, and 1000 milliamperes.

MODEL 673—for D.C. current. Eight switch selected ranges of 0-1, 5, 10, 25, 100, 250, 500, and 1000 milliamperes.

Here are two meters you can't afford to pass up—just the thing for radio servicing, transmitter trouble-shooting, general lab and experimental work.

A One-Time only Special buy at

795

Model 606B-VOLTAGE TESTER



Checks voltage and polarity. Range: 0-440 AC-DC volts—definite indications for 115, 220, and 440 volt lines. Separate polarized vane for AC or DC indication. Built in test leads. Excellent for checking wiring, fuses, general factory installation and maintenance. Every plant—every electrician needs several at this low price. Regular net 16.67

895

PHONO PICKUP CRYSTALS

Standard types—Set Manufacturers close-out —all Guaranteed



Webster F2—Replaces L26-L40-L70 etc.—pin type terminals—1 oz. pressure—1 volt output—5000 cycle cutoff. List price \$5.00—you pay us.....

149



SHURE P93—W57A—pin type terminals—3/4 oz. pressure—1.6 volt output—6000 cycle cut off. List price \$4.45—our Special.....

198



Astatic L-70—new post war design—solder terminals—1 1/4 oz. pressure—1 volt output—4000 cycle cutoff. List price \$5.55—we quote you

198

MIDGET I. F. TRANSFORMERS



400-500 Kc range—1 1/4" square x 2 3/4" high—ceramic based mica trimmers—high gain iron cores—pep up old receivers—ideal for new construction. List price \$2.10—up to 88% discount—stock up now for future use.

Each 29c Dozen 339 1000 red 2500



MULTI-USE WIRE

Stranded No. 22 tinned wire—glass "ROCKBESTOS" 1000 volt insulation—fireproof aircraft wire—a wartime development—at this low price you can use the best—

100 feet.....

45c

1000 feet.....

389

TRIPLETT VOLTMETERS



Panel meters by Triplet! Top quality instruments—new—boxed—five popular types—priced right—your chance to get those meters you've always wanted—

MODEL 332—0-150 A.C. volts—3" round flush mounting black brass case.
MODEL 231—0-150 A.C. volts—2" round flush mounting bakelite case.
MODEL 237—0-150 A.C. volts—2" square flush mounting bakelite case.
MODEL 221—0-30 D.C. volts 2" round flush mounting bakelite case.
MODEL 324—0-400 D.C. volts—3" round projection mounting—bakelite case.

295

EACH

GENERATOR CONDENSERS



PHILCO part No. 61-0177—5 mfd.—1/4" x 1 1/4"—4" lead-slotted mounting strap for easy installation—Standard Merchandise—not war surplus—Present list price \$1.00. Our special—over 85% off

14c

OUTPUT TRANSFORMERS

Clean stocks — long leads — mounting feet — made to fit where you need them. For 6F6-6K5—to 4 ohm voice coil—size 2" x 1 1/2" x 1 3/4". 50L6-351A-251A to 4 ohm voice coil 1 5/8" x 1 3/8" x 1 3/8". Specify quantity of each type you need at.....



49c

RESISTANCE LINE CORDS

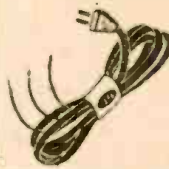

Standard 3 terminal 135 ohm AC-DC cords—sturdy construction—flexible—5 1/2' long—complete with plug—for sets, having approximately 69-75.2 volts drop in the filaments—Regular list price 1.17—

Only 33c

Pep-Up PHILCO CHANGERS

At last! All the parts you need to restore brilliant tone and volume to "sick" changers! You'll need all three items—sell your customer a 100% reconditioning job—Selenium cell only, no holder..... \$1.80
Sapphire needle only, no mirror..... \$1.20
Special original equipment lamp..... 27c
RECONDITIONING KIT—all three above items—postpaid—special at.....

321

CATHODE CONDENSERS



10 mfd. at 25 working volts—1 1/4" x 1 1/4" tubular type—aluminum case—overall cardboard sleeve—tinned leads—quality construction by a national manufacturer—backed by the famous R. S. & E. guarantee—list price 75c. Priced to make you money at 12c each lots of 10 for 108 100 for 900

Order from the Ad

Write - Wire - Phone

Include full remittance with orders of \$3.00 or less. Include 25% deposit with all C.O.D. orders of \$3.00 or more. All shipments sent express collect if postage is not included. Prices subject to change without notice.

SEND FOR FREE CATALOG

RADIO SUPPLY & ENGINEERING CO., Inc.

125 SELDEN AVE.

DETROIT 1, MICH.

BUILDERS! EXPERIMENTERS!

**Make ALLIED
Your RADIO KIT
HEADQUARTERS!**

**HI-FIDELITY
BROADCAST
TUNER**

An easy-to-build high-fidelity TRF Tuner Kit. Features broad band reception for higher fidelity than obtainable in standard superhet circuits. Linear diode detection for quality demodulation; separate diode AVC for constant signal. Cathode follower output circuit. "Magic Eye" tuning. Vernier dial, 0-100, 5-1 ratio. Built-in power supply. Complete with all quality parts, including 5 tubes plus rectifier, punched chassis (10x6 1/2 x 3") and panel, matched coils and detailed 4-page instruction booklet for 110-125 volt, 60 cycles A. C. **'2425**

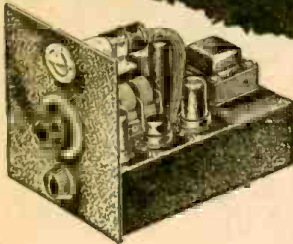

**10-WATT
HI-FI
AMPLIFIER**

One of the finest high-fidelity audio amplifiers ever designed for home construction—a perfect companion for tuner above, or for use with crystal phone pickup. Inverse feedback for wide response ± 1.5 db from 20 to 10,000 cps. Minimum distortion. High imp. input, volume and tone controls; large output transformer matches any 6-8 ohm PM speaker. Complete with all quality parts, including 4 tubes plus rectifier, punched chassis (10x6 1/2 x 3"), and detailed 4-page instructions. **'2175**

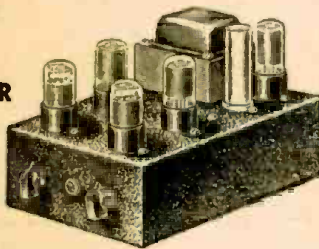

"BUILD-YOUR-OWN" DIAGRAMS

- 38-034. 5 tube AC-DC Superhet
- 38-035. 2 tube "Ocean Hopper"
- 38-036. Crystal Set
- 38-037. Remote Phono-oscillator
- 38-038. 4 watt AC-DC Phono-Amp
- 38-039. 4-tube AC-DC TRF Set
- 30-040. 2-Meter Transceiver
- 30-041. TRF Broadcast Tuner
- 38-042. 10-watt HI-FI Amplifier
- 38-043. Electrical Timer
- 38-044. Radio Lab.
- 38-047. Ranger AC-DC Superhet

**5c
EACH**
Clear, easy-to-follow instructions. Complete kits available from ALLIED.

**FREE! 164-PAGE ALLIED CATALOG!
EVERYTHING IN RADIO
AND ELECTRONICS AT
LOWEST PRICES!**



ALLIED RADIO

ALLIED RADIO CORP.
833 W. Jackson Blvd., Dept. 2-KK-7, Chicago 7, Ill.

- Send FREE 164-Page Catalog
- Send Kit No. 83-221
- Send Kit No. 83-222
- Send Diagrams Nos.

Name.....
Address.....
City.....Zone.....State.....

10-METER CONVERTER

(Continued from page 30)

being grounded, but may be ungrounded and brought to the front panel for use as a double input. L2 on the same 5/8-inch form consists of 8 turns of No. 16 tinned copper wire. It is tuned by the variable condenser C2. To obtain band spread between 27 and 30 mc it may be necessary to shunt the variable condenser with a 10- μ mf Ceramic or adjust the coil spacing until the desired result is obtained.

T2 is the oscillator coil arranged as a modified Hartley. It consists of L3 and L4 (one winding) on a 1/2-inch form. The full coil has 20 turns of No. 20 enameled wire and is tapped at 6 turns from the ground end. C7 controls the adjustment of the fixed oscillator frequency and is a 100- μ mf padder which is adjustable through a hole in the front panel. R2 is a 20,000-ohm resistor, that value being chosen for optimum oscillator grid current. R1 and R3 are the screen-dropping voltage divider resistors, and C4 acts as the screen by-pass. These values were selected to attain proper screen voltages from a variation of 50 to 250 volts that may be encountered by tapping power from the B-plus supplies of various receivers.

The plate coil is a special brass slug-tuned coil T3. (This is actually the R compensation coil from the control head of an Army mine detector. [See figure on page 676, July, 1946, RADIO-CRAFT.] These are available in many places as surplus, but if not obtainable a coil may be constructed as described below.) The brass slug reduces inductance when inserted into the coil. With the slug all the way in, resonance occurs in the 14-mc region. With the slug all the way out, resonance occurs in the 11-mc region. The circuit has a low Q, which is desirable, as it will not be necessary to manipulate this control while tuning the receiver. A 12-mc, air-tuned condenser circuit may be substituted for the slug-tuning arrangement used here. Coupling from the plate to the receiver then can be a 10- μ mf condenser. The brass slug-tuned coils are then constructed of No. 18 d.c.c. wire on a 3/8-inch form. Both the coils have 24 turns and are tight-coupled by adjacent winding. Dimensions of coil forms are given in Fig. 2.

The output coupling condenser C6 is of the value needed to allow trimming adjustment of those receivers that have an antenna trimmer on the front panel, and will be correct for most receivers. To simplify the switching in the converter and to prevent the converter from loading the antenna input to the re-



**RCA VICTOR
EYE WITNESS TELEVISION RECEIVERS**

Plate Face Pictures, 13 Channels.
Model 621TS—7" Set \$296.80
Model 630TS—10" Set 432.60
Model 641TV—10" Console, Including Television, Automatic Record Changer, F.M. and A.M. radio 888.00
Prices above include original RCA Factory Installation in their service areas as well as guaranty for 12 months on the set and kinescope. City sales tax where applicable added.

LATEST TELEVISION COMPONENTS

Part No. Price
47204X RCA FRONT END consisting of a complete television 13 channel tuning assembly including tubes, coils, switch, input converter, IF transformer and fine tuning capacitors, ready to attach to a suitable IF input \$97.50

TELEVISION I-F AND VIDEO COIL KIT

47204X1 RCA IF and Video coil kit contains all the necessary IF and video coils for a complete 4 megarcycle wide band-pass as well as the sound IF and discriminator transformers for a complete television set \$33.00
I.F. Video frequency—25.75 MC
I.F. Sound frequency—21.25 MC
47201D1 Deflection YOKE for use with 7DP4, 10DP4, 15DP4 magnetically deflected tubes 13.75
47201D2 Deflection YOKE for use with 7TP4 Projection kinescope 14.90
47201X1 Yoke mounting hood for above yokes 2.75
47201D1 Magnetics focusing coil for 5TP4, 10BP4, 15DP4 for use in series with divider 9.10
48202DIX Magnetics focusing coil for same as above but 10,000 ohm D.C. resistance. 9.90
47203D1 Ion trap magnet for tubes 7DP4 and 10BP4 6.50
47211T1 Horizontal output transformer with 9000 volt kick-back output for 2nd anode 16.85
47208T8 Horizontal blocking sync. discriminator transformer as used in RCA AFC circ. 4.75
47208TX Horizontal blocking oscillator transformer UTC high perm. Iron. SPECIAL 2.75
47201H1 Horizontal width control for use with 7DP4 and 10BP4 or 15DP4 1.30
47201B1 Spherical mirror for use with 5TP4 in projection systems 150.00
47201P2 Aspherical correcting lens to use with above mirror 50.00
47204T2 Vertical output transformer 9.00
47208T2 Vertical blocking oscillator transformer RCA 5.70
475218 FRAME with shatterproof glass and rubber mask for use with 12AP4 tube 8.00
475300 H.V. capacitor. .03 mfd 7500 volt working, grounded negative GE Pyranol 3.75
475301 H.V. capacitor. .1 mfd 7500 volt working, grounded negative GE Pyranol 7.50
475302 H.V. capacitor. 2x.1 mfd 7000 volt working, grounded negative GE Pyranol 9.00
475303 H.V. capacitor. .05 mfd 16000 volt working, grounded negative Sprague 9.90
475305 TRANSVISION 7 inch Television Kit, all parts and tubes included 159.50
475306 Transvision 12" Television Kit 289.50
Large assortment of peaking coils, ceramic capacitors and ceramic trimmers.

**RCA HIGH FREQUENCY SWITCH
AND COIL ASSEMBLY**

RF unit, used in TRK12 RCA television receivers consisting of 3 band pass switches with shield, plate and mounting studs, including 5 polystyrene antenna coils, permeability tuned, each consisting of primary ring, secondary coil and primary mica capacitors. The assembly can be used in TELEVISION, F.M. and other HIGH FREQUENCY APPLICATIONS
CATALOG No. 5210—Special price \$5.60

RCA VARIABLE TUNING CERAMIC CAPACITOR

To be used in conjunction with the above switch assembly 2-4.5 MMFD.
CATALOG No. 5211—Price \$2.10

CATHODE RAY TUBES

Type	Make	List Price	Your Price
5BP1	DUMONT	\$24.75	\$ 7.95
5BP4	RCA	27.50	7.95
5CP1	PHILLIPS	24.50	7.95
5JP4	DUMONT	90.00	7.95
5TP4	Projection RCA	67.75
7DP4	RCA	14.95
7EP4	DUMONT	23.25
7GP4	RCA	24.25
9AP4	RCA	62.50
10BP4	RCA	49.75
12AP4	RCA	75.00
15AP4	DUMONT	129.50
20BP4	DUMONT	270.00

All tubes are brand new, perfect, in factory scaled cartons, late production.
Send 50 cents for complete catalog including diagrams for RCA, G.E., Dumont, Andrea and Viewtype Television Receivers.

World's First Specialized House in Television.

TELETRONICS SERVICE AND SUPPLY CORP.

264 WEST 40TH STREET NEW YORK 18, N. Y.
Phone PENNSYLVANIA 6-8730

LCETI

SEE PAGE 8

ceiver when normal input is desired, the bottom of the output coil is connected to B+. This is effectively ground at radio frequency, and when S-1 is opened to restore the antenna directly to the receiver, the output does not shunt the antenna to chassis. S-1 is therefore the band-change switch. It is a double-pole, double-throw switch arranged so that B+ and antenna circuits are connected to the converter in one position, while in the other position the B+ is removed and the outside antenna connects through the converter to the receiver antenna post with minimum attenuation. The antenna may be left connected to the converter at all times, and the converter permanently connected to the receiver.

Power supply connections

Power for operation of the 6SA7 converter tube is taken from the receiver to which it is attached by a cable with a tube base and socket fitted to the end which can be plugged into an i.f. stage of the set. The i.f. tube is then refitted into the adapter. As all sets have different arrangements for filament supply and B+ at the i.f. socket, different ways to arrange cable wiring are required. The figures show typical arrangements for use with some of the commonest Army and Navy sets. For the BC-312 and BC-342 the 12-volt filament supply

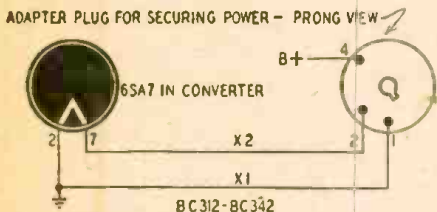

Fig. 3—Connections for BC-312 and BC-342.

is arranged as shown in Fig. 3. For those sets which use a 28-volt filament supply, it is necessary to employ a 60-ohm filament-dropping resistor. Sets which are wired with a 6.3-volt filament with the center tap to ground will have to have an extra wire in the cable to carry the other ungrounded side, or the center tap will have to be ungrounded. For use with the BC-348 the screen supply of the i.f.—usually tapped for the converter—is much too low. Using this set, it is necessary to wire directly to the power supply terminal.

The entire unit can be housed in a standard commercial metal box 5 x 4 x 3 inches. All parts are mounted on the front panel, with the tube socket mounted on a bracket which allows it to lay parallel to the panel. Keep the input and output coils at right angles because of the lack of shielding between them. A hole should be drilled in the front or side of the box to allow the oscillator frequency to be set.

Lining up the converter

Calibration and adjustment of the converter is very simple. Hook the converter to the antenna post on the receiver with a short length of shielded, low-capacity cable. Plug the power cable
(Continued on page 65)

Just Out!

THE GREAT NEW COMPLETE

CONCORD

Radio Catalog



RADIO PARTS
RADIO SETS
AMPLIFIERS
TESTERS
ELECTRONIC
EQUIPMENT
HAM GEAR

160
VALUE-PACKED
PAGES

MAIL COUPON BELOW FOR FREE COPY

It's ready now—the new Concord Radio Catalog offering the greatest, latest and most complete presentation of radio, electronic and television equipment and supplies in radio history! Just off the press, this new Concord catalog is packed from cover to cover with thousands of items to fill every radio and electronic need—Radio Parts, Radio Sets, Amplifiers, Sound Systems, Test Equipment for every purpose, Record Players, Record Changers, Television Equipment, Ham Gear, Kits, Receivers, Transmitters—160 pages of everything and anything in Radio and Electronics. Complete showing of Amplifiers and Sound Equipment—including famous Concord Multi-Amp Add-A-Unit Amplifiers. Special bargain section offers hundreds of money-saving values in top quality, standard-make parts—including scores of new items from nationally-famous makers. Immediate shipment from stocks in two huge Concord warehouses centrally located in CHICAGO and ATLANTA. Mail the coupon now for your FREE copy.

WANTED—TRADE-INS ON COMMUNICATIONS EQUIPMENT—Depend on Concord for highest trade-in values on communications receivers. Write, phone or call to tell us what you have—or send it in for free appraisal.

TIME-PAYMENT PLAN—Buy your Radio and Electronic Equipment from Concord on EASY PAYMENTS—Communications Receivers, Transmitters, Radios, Radio-Phonos, Sound Equipment, Test Equipment. Write us your needs.

CONCORD

RADIO CORPORATION

CHICAGO 7 * ATLANTA 3

901 W. JACKSON BLVD. 265 PEACHTREE ST.

LAFAYETTE RADIO

Concord Radio Corporation, Dept. RC-107
901 W. Jackson Blvd., Chicago 7, Ill.
Yes, rush FREE COPY of the comprehensive
new Concord Radio Catalog.

Name.....

Address.....

City..... State.....

RADIO AND ELECTRONIC KITS FOR ALL PURPOSES

FIVE TUBE AC-DC SUPERHET KIT:

Furnished in a brown plastic cabinet of artistic design, cabinet size (9"x5"x6"). Variable condenser tuned with 2 double tune I.F.'s. Tubes used: 1-12SA7, 1-12SQ7, 1-35Z5, and 1-50L6. **PRICE \$12.45**
(Including 5 Standard Tubes)

SIX TUBE 3 WAY PORTABLE KIT:

For operation on 110 volt AC or DC and battery. Superheterodyne circuit. Full vision dial. High gain loop. Cabinet of Blue Aeroplane cloth finish, size 13x9 1/2 x 7". Tubes used 1A, 1H5, 3Q5, 117Z6 and 2-1N5. **PRICE \$13.75**
Not including tubes or batteries. Extra for kit of Tubes \$3.75

SIX TUBE, 2 BAND SUPERHET KIT

Bands covered BC 550-1600 KC. Power supply 105-125V AC-DC. Full vision dial. Variable condenser tuned with two double tuned I.F.'s. 455 KC. Walnut veneer wood cabinet. **PRICE \$16.45**

THREE TUBE PHONO AMPLIFIER

An assembled unit ready for installation using 2-1632 and 1-12SN7 tubes, tone and volume control and six feet of rubber cord. **PRICE \$3.95**
(Including Tubes)

PHONO OSCILLATOR

Wireless phono oscillator transmits recording for crystal pick-ups or voice from carbon mike through radio without wires. Can also be used as an intercomm by using P.M. speaker as mike. Price (excluding tubes) **\$2.95**

If You Need Tubes—We've Got 'Em!

Type	Pr.	Type	Pr.	Type	Pr.	Type	Pr.
#30	\$.45	3D6/1299	\$.65	7F7	\$.55	VR90	\$.50
#32	.45	3B7/1291	.65	7F8	.65	VR105	.50
#33	.45	12/A6	.40	6L7	.55	RK72	1.95
#38	.45	6G6	.40	836	.85	RK73	1.95
#46	.45	6Y6	.40	1005	.65	723A/B	.95
#50	.85	12K8Y	.65	1629	.45	724B	.85
#76	.35	12SF5	.65	1632	.45	3FP7	1.65
28D7	.65	12Q7	.45	1633	.45	5FP7	1.95
1R4/1294	.65	3Q5	.55	1644	.45		

CHECK THESE SENSATIONAL PRICES

RADIO DEALERS SUPPLY CO.

135 Liberty St., New York, N. Y.

Available, a large stock of radio parts, test equipment, etc., at attractive prices. Write for free catalogue.

All Prices are
F. O. B.
New York City

WE SHIP
ANYWHERE
PROMPTLY

Ever Sit On A Gold Mine?



YOU CAN BUILD a business of your own NOW — either part or full time — with **TRADIO**, the radio functionally designed for coin-operation in hotels, motels, stopovers, hospitals, etc. Big earnings... Steady income... and no clock to punch unless you want to.

★ Only Small Investment Needed

Tradio has pioneered in this new and fast-growing industry. Get in on the ground floor and assure yourself of financial independence for life.

★ Tradio-Tried, Tested, Proven

Thousands of others all over the country have learned that "Tradio Pays While It Plays." Send for complete information today.

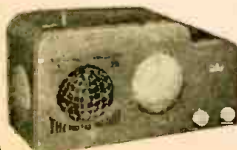

Write to Dept. U-10

TRADIO, Inc. ASBURY PARK NEW JERSEY

PLOUGHING BY RADIO

(Continued from page 54)

control of several tractors, by automatic radio-directed devices presents little difficulty. It would appear that there is a wide field for improvement and ingenuity in agricultural machinery and farming techniques but quite how far it is possible to go in the matter of "armchair control" is debatable.

If the engineer and scientist can devise equipment which is easily serviced and thoroughly reliable in operation, there is a fair chance of automatic control being a marketable feature. The limitations of simple radio control lie mainly in the ability of the controller to see the object he is controlling; once the object is out of view there is no certainty as to precisely what it is doing, nor of the response to executive signals.

Much of this objection is overcome by ensuring that the equipment is reliable and by arranging the circuits so that undesirable conditions are prohibited—for example a failure in the reception of signals should definitely stop the machine and not leave it running more or less out of control. Prohibitions of this kind are simple and very necessary.

One line of attack very well might be an arrangement wherein a master tractor, carrying the controller, is fitted with the transmitter; the controller then operates a set of slave tractors all of which are in his immediate vicinity.

ALMO ☆ ☆ SPECIALS



☆ Army surplus Panadaptor spots FM or parasites on an AM signal, measures quality and percentage of modulation on signal, checks other frequencies against known standard, spots frequency drift, and shows how to shift frequency in QSO. Brand new, in original cartons, special at \$49.50.

☆ Sensational new FM Pilotuner brings FM to your radio at an unusual low price. Lose static and noise in any AM radio with this tiny compact FM unit. Five tubes plus selenium rectifier, 3 gang copper condenser for increased stability. Almo has them in stock for immediate delivery now at \$29.95.

10% Cash with Orders **ALMO** Phone LO 3-9225
Covers the Globe
509 ARCH STREET PHILADELPHIA, PENN.

TIK for KITS

Servicemen • Amateurs • Jobbers

Look at these values

Mica Condensers, Assorted 100 for	\$3.49
Allen Bradley, etc., Volume Controls 50 ohm, to 1 meg. 12 for	\$2.59
Carbon Resistors, Color Coded. 1/2, 1 & 2 Watt 100 for	\$2.50
Wire Wound Resistors, Ward Leonard, etc. 5 to 75 Watt 20 for	\$2.98
Fuses, Buss & Littelfuse 100 for	\$1.89
Assorted Oil filled condensers, tubular and bath tube type. 400 V, 600 V, 1000 Volts 12 for	\$2.49
Oetal and 4 prong Ceramic Sockets (without rings) 100 for	\$3.98
Condensers .05 mfd, 2,000 volt to .25 mfd 3,000 WVDC 6 for	\$3.59
Precision Wire Wound Resistors, Shall- cross, Mecco, etc., 1/2, 1/4 and 1 Watt 15 for	\$2.98

SPECIAL COMBO KIT

OUR INTRODUCTORY OFFER
Excellent Assortment

Big Value
Tremendous Savings

This kit includes a quantity
of items listed in the above
kits, PLUS many others. It's
our New Customer Special.

\$10.98

Minimum order \$2.00

25% deposit required on all C.O.D. orders.

Add postage Write Dept. RC0

TIK 55 WALKER ST.
NEW YORK 13, N. Y.
phone CA nial 6-7485

Do you need

BINDING POSTS?



The XL PUSH POST with the Spring
Action assures Constant Contact and
quick connection.
Manufactured in All Aluminum Type M
at 12c each.
Aluminum Body, Bakelite Top Type B1
at 15c each.
Types CP or NP, ALL BRASS—STAIN-
LESS STEEL SPRING & PIN, PROVEN
by 240 HR. SALT SPRAY TEST as NON-
CORROSIVE at 28c each.
Manufacturers and Dealers Liberal
Discounts

X. L. RADIO LABORATORIES
420 West Chicago Ave., Chicago 10, Ill.

Amazing! POCKET
OR PURSE SIZE
NEW RADIO

WORLD'S SMALLEST RADIO KNOWN!
Wt. only 1/2 lb. Beautiful Silver Black plastic
case. Has Inductive Slide Tuner—W6 Crystal
Diode—NO TUBES, BATTERIES OR ELECTRIC
"PLUG IN" NEEDED! Should last for years!

GUARANTEED TO PLAY NEW 1943 MODEL

on local stations if complete instructions sent
are followed. Use it at home, in bed, in many offices, hotels, cabins—most any-
where. HUNDREDS OF SATISFIED CUSTOMERS ALL OVER THE WORLD!

SEND ONLY \$1.00 (Cash, M.O. Check) and pay postman \$2.99 plus de-
livery fees on arrival or send \$3.98 for Post Paid

Complete as shown—ready to play with self contained personal phone.
WONDERFUL GIFTS FOR CHILDREN! Order now at this low bargain price—
Prompt shipment on orders sent now—today! Be the first to get YOUR Pocket
Radio! Full foreign orders \$5.00 U. S. cash with order!

Pa-Kette Radio Co., Inc. Dept. RC-10 Kearney, Nebr.

Colorfax, new color facsimile equip-
ment introduced by Finch Telecommuni-
cations, uses ordinary colored pencils to
trace its picture. Pencils, in magnetic
cylinders, revolve around an axis draw-
ing horizontal lines on the paper. A
scanner working through color filters
transmits current to each cylinder in
proportion to the color strength of the
copy scanned, thereby regulating the
pencil pressure and reproducing the
original in its own colors.

10-METER CONVERTER

(Continued from page 63)

into the set. The receiver is first used
to adjust the oscillator. Tune the re-
ceiver to 16 mc. Adjust the padder on
converter through the hole in the panel
until it comes in on the receiver at 16
mc. If the receiver does not have an
S-meter or a beat-frequency oscillator,
raise the gain control until the noise
level cuts out. Locating the oscillator
signal on the receiver is easy, as it is
strong. Since this adjustment is quickly
and easily made, the calibration of the
unit can be readily checked and reset in
case of drift. When the frequency has
been set up, tune the receiver to the
band that covers from 11 to 14 mc and
tune in a 10-meter signal. Adjust the
input and output controls on the con-
verter to peak intensity. All peak indi-
cations will be broad, so that a peak
indication set somewhere in the middle
of the band will hold true for all sta-
tions. For very weak signals a slight
adjustment may help occasionally. Gen-
erally, the only control to be varied
will be the normal receiver tuning. New
frequency readings of the dial can be
made easily by simply adding 16 to the
dial reading. The 16 has already been
established by previous calibration,
making the new calibration accuracy of
the same order.

Certain precautions should be taken
to prevent the break-through of strong
stations operating on the intermediate
frequency used. Proper shielding of the
antenna lead to the receiver from the
converter will reduce stray pickup and
minimize interference. Good grounding
of the cable at both ends is important.
If the interfering signal is very strong,
the oscillator frequency can be readjust-
ed to shift the station outside the band
so that no interference is experienced.

A converter such as the one described
can be made small and compact and
easy to mount on the side of the receiver.
It is simple and inexpensive to con-
struct and requires no additional power
supply. Since all adjustments are preset
and do not require constant resetting,
it makes a very useful device for ex-
tending the frequency range of your
receiver.

Priced for Quick Disposal

CW-3 WILCOX

RADIO RECEIVERS \$12.75 EACH

Express Collect

While they last—Any Quantity

Superhet circuit 1900-16500 K.C.; 110 Volt
60 Cycle AC; one stage R.F. B.F.O., noise
and sensitivity controls; audio output
limiter; rack mounting; complete set spare
tubes; complete with coils; original crates.
Dept. R.

AMERICAN MDSE. MART
411 Finance Bldg. Philadelphia 2, Pa.

READ FOR PROFIT!

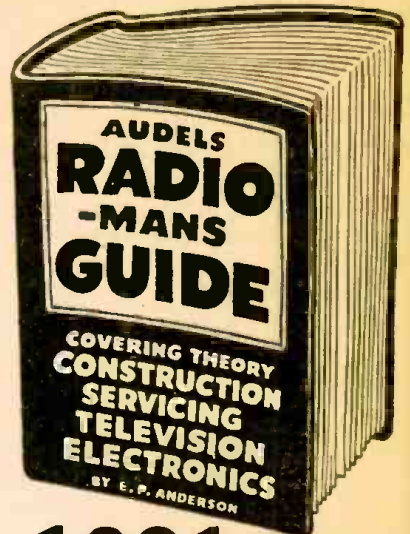

1001 RADIO FACTS AND FIGURES

AUDELS RADIOMANS GUIDE—914 Pages, 633 Illus-
trations, Photos, Wiring Diagrams, 38 Big Chapters,
covering Radio Theory, Construction, Servicing, Includ-
ing Important Data on Developments in Television,
Electronics and Frequency Modulation, Review,
Questions and Answers, Calculations & Testing.
Highly Endorsed—Indispensable for Ready Reference
and Home Study.

\$4 COMPLETE • PAY ONLY \$1 A MONTH
Step up your own skill with the facts and figures of
your trade. Audels Mechanics Guides contain Prac-
tical Inside Trade Information in a handy form.
Fully Illustrated and Easy to Understand. Highly
Endorsed. Check the book you want for 7 days'
Free Examination.

Send No Money. Nothing to pay postman.

CUT HERE MAIL ORDER

AUDEL, Publishers, 49 W. 23 St., NEW YORK 10, N. Y.

Please send me Postpaid for FREE EXAMINATION books
marked (x) below. If I decide to keep them I agree to
mail \$1 in 7 days on each book ordered and further
mail \$1 monthly on each book until I have paid Price.
Otherwise, it will return them.

- RADIOMANS GUIDE, 914 Pages . . . \$4.
- ELECTRICIANS EXAMINATIONS, 250 Pages . . . 1.
- WIRING DIAGRAMS, 210 Pages . . . 1.
- ELECTRICAL DICTIONARY, 9000 Terms . . . 2.
- ELECTRICAL POWER CALCULATIONS, 425 Pgs. . . 2.
- HANDY BOOK OF ELECTRICITY, 1340 Pages . . . 4.
- ELECTRIC DEVICES, 216 Pages . . . 2.
- OIL BURNER GUIDE, 12 vol., 7000 Pgs., \$1.50 vol. . . 1.
- REFRIGERATION & Air Conditioning, 1280 Pgs. . . 4.
- POWER PLANT ENGINEERS Guide, 1500 Pages . . . 4.
- PUMPS, Hydraulics & Air Compressors, 1658 Pgs. . . 4.
- WELDERS GUIDE, 400 Pages . . . 1.
- BLUE PRINT READING, 416 Pages . . . 2.
- SHEET METAL WORKERS Handy Book, 388 Pgs. . . 1.
- SHEET METAL PATTERN LAYOUTS, 1100 Pgs. . . 4.
- AIRCRAFT WORKER, 240 Pages . . . 1.
- MATHEMATICS & CALCULATIONS, 700 Pgs. . . 2.
- MACHINISTS Handy Book, 1600 Pages . . . 4.
- MECHANICAL Dictionary, 958 Pages . . . 4.
- AUTOMOBILE GUIDE, 1540 Pages . . . 4.
- DIESEL ENGINE MANUAL, 400 Pages . . . 2.
- MARINE ENGINEERS Handy Book, 1280 Pages . . . 4.
- SHIPFITTERS Handy Book, 272 Pages . . . 1.
- MECHANICAL DRAWING COURSE, 160 Pages . . . 1.
- MECHANICAL DRAWING & DESIGN, 480 Pgs. . . 2.
- MILLWRIGHTS & Mechanics Guide, 1200 Pgs. . . 4.
- CARPENTERS & Builders Guides (4 vols.) . . . 6.
- PLUMBERS & Steamfitters Guides (4 vols.) . . . 6.
- MASONS & Builders Guides (4 vols.) . . . 6.
- MASTER PAINTER & DECORATOR, 320 Pgs. . . 2.
- GARDENERS & GROWERS GUIDES (4 vols.) . . . 6.
- ENGINEERS and Mechanics Guides . . . 12.
- Nos. 1, 2, 3, 4, 5, 6, 7 and 8 complete . . . 1.
- Answers on Practical ENGINEERING . . . 1.
- ENGINEERS & FIREMANS EXAMINATIONS . . . 1.

Name _____
Address _____
Occupation _____
Employed by _____ R. C. F.

SENGO DECLARES A BUYER'S DIVIDEND

100,000 RADIO TUBES

Every tube guaranteed. Every tube in carton.

Type	Each	Each	Type	Each	Each
1H5GT	59	45	7X7	44	35
IU5	36	30	7AF7	44	35
IN5GT	59	45	14X7	44	35
1V	45	39	12A8GT	54	45
1L4	55	49	12C8	80	70
2A5	65	55	12J5GT	49	39
3Q5	79	70	12I7GT	45	39
5U4G	55	40	12K7GT	45	39
5W4GT	40	36	12R8	65	59
5Y3GT	40	37	12Q7GT	45	39
5Y4G	40	37	12SA7GT	40	32
5Z3	40	37	12SQ7GT	40	32
6A7	53	45	12SK7GT	45	35
6A8GT	59	44	12SJ7GT	55	50
6AC7	65	60	26	39	30
6BA6	50	45	41	45	40
6B7	55	49	42	47	42
6C6	45	37	45	49	39
6C8G	45	37	47	49	41
6D6	45	37	56	49	39
6F6GT	45	40	57	45	39
6H6GT	45	40	58	45	39
6J5GT	55	50	71A	39	29
6K7GT	42	38	75	50	40
6K7GT	49	40	76	45	39
6N7	95	83	77	40	32
6Q7GT	47	42	80	40	38
6U7G	40	35	84/6Z4	45	36
6V6GT	59	49	25L6GT	60	50
6X5GT	49	40	25Z5	59	47
6SA7GT	44	37	25Z6GT	55	43
6S3GT	44	37	35L6GT	60	50
6SK7GT	44	37	35W1	45	40
6SL7GT	55	47	35Z3	44	35
6SN7GT	55	47	35Z5GT	49	39
6SQ7GT	47	42	50L6GT	58	45
6S7	44	39	117Z3	55	45
6Z5G	45	40	117Z6GT	99	89
7B6	44	35	12A76	55	45
7B7	44	35	12BA6	55	45
7C6	44	35	12BE6	55	45
7C7	44	35	50B5	42	32
7Y4	44	35	32L7GT	60	50

VM MIXER CHANGER

Model 200B, 2 Post.

Sensational Plays 10" and 12" records intermixed with no adjustment. Light crystal pickup. One control knob for on, off, manual, automatic, press to reject. 110 Volt, 60 cycle, noiseless motor. 15 x 14 x 7 1/2" H. Wgt. 16 lbs. Only **\$15.95**

OAK RECORD CHANGER-AC
110 Volts 40 cycle 2 Post-Plays
10-12" or 12-10" records.
Lightweight Crystal
Pick-up, Noiseless Motor. **\$17.45**

General Instrument
De-Luxe Record Changer With Automatic Stop

SPEAKER SALE Limited Quantity

4" P.M. Speaker.....\$1.19
5" P.M. Speaker.....1.15
6" P.M. Speaker.....1.55
8" P.M. Speaker.....2.75
Lot of 12.....30.00
12" P.M. Speaker.....30.00
Alnico 5 magnet.....5.95
Lots of 12.....66.00

Plays ten 12-inch or twelve 10-inch records at one loading, and stops automatically after last record is played **\$18.95**

829 Push Pull twin unit. Beam power amplifier tube...\$1.49 ea.

40 x 40 Electrolytic Cond. 150 V.\$.49
50 x 30 Electrolytic Cond. 150 V.49
30 x 20 at 150 V. and 20 mfd at 25 Volts45

120 Mill Power Transformer
Primary 110 V., Secondary 6.3
Rectifier 5 V., H.V. 600 V. C.T. **\$3.25**

225 Mill Power Transformer
Primary 110 V., Secondary 6.3
Rectifier 5 V., H.V. 600 V. C.T. **\$4.25**

Mallory 6V-4 prong auto vibrator.....\$1.19

LEADING BRAND AC PHONO MOTOR



60 cycles, 115 volts with Turntable with Standard Make Crystal Pickup. **\$4.35**

25% dep. on all orders. Bal. C.O.D., F.O.B. N. Y.
SENGO RADIO, Inc.
96 WARREN ST., N. Y. 7, N. Y.
TEL. CORTLANDT 7-6065

CODE OSCILLATOR

The audio system of the average radio can be used as a code practice oscillator by feeding some of the output voltage of one stage back to the input of a preceding stage. A simple way to do this is to feed some of the voice coil voltage, in proper phase, back to the grid of the first a.f. stage through a 0.001- μ f condenser.

The circuit is keyed in the voice coil leads, since the capacity of the keying leads is sufficient to sustain oscillation if the feedback circuit is keyed.

TO GRID OF 1ST A.F., 75, 8Q7, ETC., OR PHONO INPUT

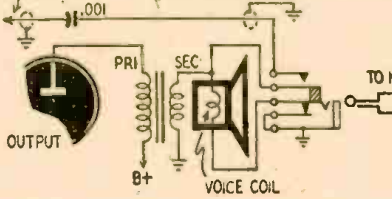

If a two-circuit jack and condenser are used as shown above, it closes the feedback circuit and opens one of the voice coil leads when the key plug is inserted. The circuit will be completed as the key is closed. If this type jack is not available, a closed-circuit jack and a low-capacity switch may be installed

TO GRID OF 1ST A.F. OR PHONO INPUT

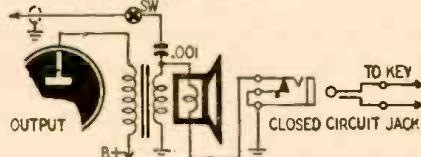

(second figure). Pitch and volume are controlled by the setting of the volume control and the capacity of the condenser.

JOSEPH SILVER,
Philadelphia, Penn.

(Other feedback circuits can be used. In radios with output transformers on the speaker, it is often possible to connect to one of the voice-coil terminals and back to the phono input.—Editor)

A. C. 110-VOLT MOTORS

Selsyn Synchro Differential—New in Original Package.

A Bargain at \$1.75 while they last

LYELL HARDWARE

P. O. Box 5, Rochester 11, New York

ELECTRONIC VOLT-OHM-METER

110 VOLTS AC 20 RANGES
0/5/10/50/100/500/1000/5000
volts DC and AC. 0-1,000,000,000
ohms in six overlapping ranges. Sensitivity: over MILLION OHMS per VOLT on 5 volt range.

Complete kit includes all component parts, tubes, punched and drilled chassis and beautifully enameled panel. Easily assembled and wired.

Special sideback circuit developed during war by scientists at the California Institute of Technology gives amazing sensitivity and flexibility while completely eliminating necessity of batteries and expensive meter. Each instrument is individually calibrated. Dial scale over nine inches long!

In addition to performing the usual volt-ohm functions, this instrument easily measures these voltages: SUPERHET OSCILLATOR, AVC, AFC, TRUE GRID BIAS AT THE GRID, BIAS CELLS without affecting the circuit. Measures the exact leakage resistance of INSULATION, TUBES, CONDENSERS. It can be used with a signal generator for SIGNAL TRACING.

STERLING ELECTRONIC COMPANY
BOWLING GREEN, KENTUCKY

FALL LEOTONE SPECIALS

GLIDE PATH RECEIVER, R-89/ARN-5A. Used in Instrument Landing. 833-335MC. Every unit in perfect condition. Complete except for crystals & tubes **\$4.95**

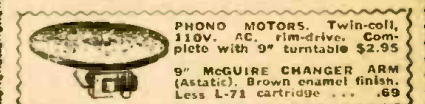

PHONO MOTORS, Twin-coil, 110V. AC, 110-drive. Complete with 9" turntable **\$2.95**
9" McGUIRE CHANGER ARM (Astatic). Brown enamel finish. Less L-71 cartridge... **.69**

TUBES: Perfect condition, but not in sealed cartons. Most types in stock at up to 80% off list. Every tube guaranteed 60 days.
#20, 26, 27, 49 or 50..... **.29**
#22, 45, 75, 77, 78, 80, 89, 5Y3, 6J6 or 6K7... **.39**
#33, 36, 37, 39, 84, 6AB, 6CS, 6DS, 6J7, 6N7, 6U7, 6X4, 6X7, 6X8, 6X9, 6Z5, 6Z6... **.49**
#1A7, 1H5, 1N5, 6A3, 6U5, 6X5, 7A7, 7C5, 7D6, 7Y4 or 30..... **.59**
TUBE CARTONS: Plain White: GT size (1 1/4" sq. x 3 3/4"). Per 100..... **1.25**
Medium size (1 1/2" sq. x 4 3/8"). Per 100..... **1.49**

SPECIAL !! - GIANT "GRAB-BAG" RADIO PARTS KIT. An outstanding buy for the SerVICEMAN or Experimentor. **15 FULL POUNDS** of coils, wire, resistors, condensers, speaker accessories, hardware etc., etc. An amazing value at **\$1.95**

Bendix Amplifier (Line of 812H) 115V, 400 cycle. Contains: Power trans. 3 audio, 6 oil condensers plus other components worth many times the price. Black chrome finish case. 7 1/2" x 5 1/2" x 5 1/2". Shipping wt. 9 lbs. **1.95**

UTC "OUNCER" INPUT TRANSFORMERS (7/8" x 1 3/16") Dynamic mike or low impedance pick-up to grid... **.49 ea.**
12 for..... **5.00**

DIPDT ANTI-CAPACITY SWITCH. Plated phosphor bronze springs. Red plastic knob... **.39**
Radio Hardware Treasure. Approx. 1000 screws, nuts, washers, lugs, etc., for every radio need **.49**

HANDY KITS FOR SERVICERS

- #1-R.F. Antenna & Osc. coils, 10 asstd. **.98**
- #2-Speaker Cones; 12 asstd. 4" to 12" (moulded & free-edge (inradius incl) Less wire coils **2.00**
- #3-MOULDED BAKELITE CONDENSERS, 50 asstd. .0001 to .2mfd, 200-600V. Clearly marked **2.95**
- #4-TUBULAR BY-PASS CONDENSERS, 30 asstd. .001 to .25mfd, 200-600V. Standard brands **2.49**
- #5-Water Sockets; 12 asstd. **.25**
- #10-Voltage Dividers; 10 asstd. multi-tipped. High wattages included **1.98**
- #14-Volume & Tone Controls; 10 asstd. wire-wound & carbon. Less switches **1.49**
- #17-Dial Windows; 12 asstd. flat & moulded acetate & convex glass **1.29**
- #18-Bakelite Coil Forms; 18 asstd. popular sizes up to 3" diameter **.98**
- #20-SPEAKER REPAIR KIT. A real money & time saver. Contains: 25 asstd. paper rings, 10 spiders, 25 voice coil forms, 3 yds. felt strips, 20 chamois leather segments, kit of 16 shims & tube of speaker cement **2.49**
- #22-RESISTOR ASSORTMENT; 20 asstd. carbon & wire-wound; 1/3 to 3 watts **.49**
- #23-RADIO CEMENT & SOLVENT; 3 oz. each of all-purpose cement & thinner. With brush **.69**
- #24-Shaft Extenders, Reducers, Couplings; 10 asstd. most popular types **1.29**
- #25-Spring Assortment; 60 asstd. compression & expansion for dials, push-buttons, relays **.98**
- #26-SPEAKER CONE RINGS; 50 asstd. cardboard rings in popular sizes, 3" to 12" **1.49**

SELSYN SYNCHRO-TRANSMITTERS, 115V, 60 cycle. Used in pairs as trans. & follower. 3 1/2" x 5". Shpg. wt. 6 lbs. ea. **2.95**
2 for..... **5.49**



P-23 HEADPHONES-8000 ohms impedance. 2500 ohms adjustable. With 5 ft. cord & PL-55. **1.49**

Rubber Phone Cushions, Per Pair **.20**

PL-354 plug & 18" tipped double cord **.19**
JK-26 ext. Jack for PL-54/354 **.23**

ALNICO MAGNETS

Powerful ALNICO MAGNETS of every size and shape always in stock. Write for latest fully descriptive illustrated supplement.
PROMPT SERVICE ON ALL SPEAKER & PHONO PICK-UP REPAIRS
Minimum Order \$2.00-20% Deposit Required on All Orders. Please Add Sufficient Postage.
WRITE DEPT. RC-10

LEOTONE RADIO CO.
MAKERS OF CONES AND FIELD COILS
65-67 DEY STREET, NEW YORK 7, N.Y.
WORTH 2-0284-5
12,000 SQ. FT. OF RADIO PARTS

UNBELIEVABLE VALUE!!

a Multi-Range VOLT-OHM MILLIAMMETER **AND** ALL-WAVE SIGNAL GENERATOR



BOTH FOR ONLY 34.⁸⁵

Don't pass up this amazing introductory offer! Rush your order now for this sensationally low-priced combination. Skeptical? . . . of course . . . but rush your order anyhow. We guarantee to refund your money in full if the units do not meet with your complete approval after a 10-day FREE trial.



Specifications of Model M-50

- Accurate Pocket size V.O.M. using full size D'Arsonval meter.
- 4 A.C. VOLTAGE RANGES: 0-15/75/300/1500 volts.
- 4 D.C. VOLTAGE RANGES: 0-15/75/300/1500 volts.
- 2 D.C. CURRENT RANGES: 0-15/150 MA.
- 2 RESISTANCE RANGES: 0-10,000 ohms; 0-1 Megohm.
- Attractive modern black & white panel.
- Beautiful hand-rubbed oak case. Complete with test leads and all operating instructions.

Specifications of Model B-45

Generates RF frequencies from 150 Kc. to 50 Mc. Modulation is accomplished by grid-blocking action—equally effective for alignment of amplitude and frequency modulation as well as for television receivers. Self-contained batteries. All calibrations etched on front panel for DIRECT READING. Beautiful processed dualtone front panel in heavy gauge crystalline steel cabinet. Complete with test leads and batteries.

20% deposit required on all C.O.D. orders.

MOSS ELECTRONIC DISTRIBUTING CO.

68 WESTCHESTER SQ.
Dept. RC-10 New York 61, N.Y.

RADIO SET AND SERVICE REVIEW

(Continued from page 33)

chassis. A tuned filter is used at the output of the 5Y3-GT rectifier. An OD3 voltage regulator delivers regulated voltage to the local oscillator, r.f. amplifier and first detector screen grids and to the b.f.o. Battery power may be

used for portable or emergency operation by using a 6-volt storage battery and a 135- to 250-volt B-battery. Connections are made to a special socket at the rear. All receiver functions are normal with battery operation.

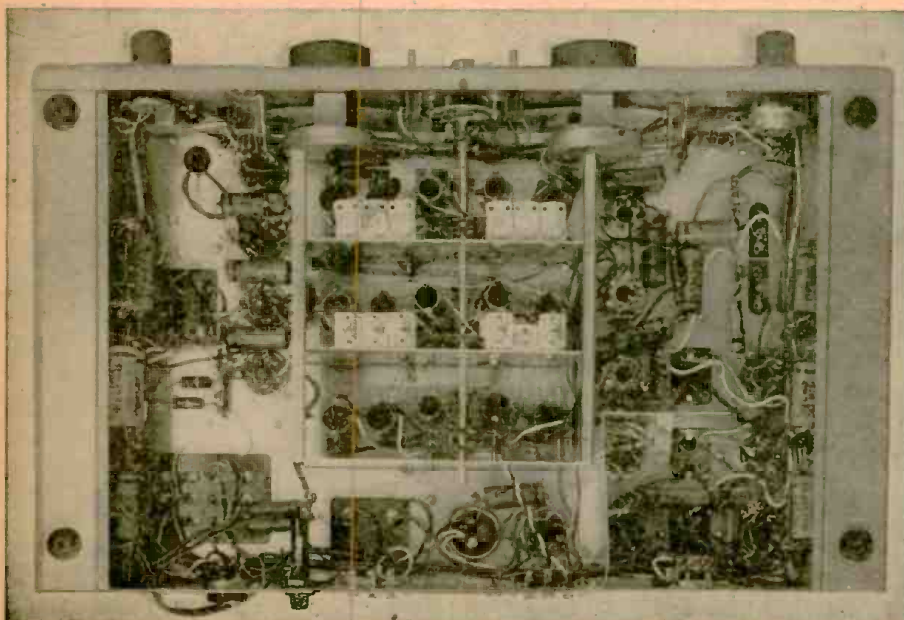

Under-chassis view of the National NC-173. Note placement of trimmers along the center.

An accessory-connector socket provides a convenient connecting point for such accessories as FM adaptors, crystal calibrators, converters, and other equipment that may require power from the receiver. The a.v.c. line is tied to one of the terminals so that control voltage may be applied to a converter or pre-selector, or the a.v.c. systems of 2 receivers can be tied together for diversity reception. One terminal on the socket parallels the phono input jack so a.f. signals may be supplied from the rear. In this event, a dummy phone plug should be inserted in the phono jack.

The NC-173 was tested in a very poor receiving location in downtown Manhattan. It proved to be highly sensitive and selective enough to provide single-signal reception of phone or c.w. signals. The antenna trimmer works wonders in bringing a weak signal out of the S5 to S8 noise level common to this location.

The cabinet provides good electrical shielding, making it impossible to pick up any but the strongest of local stations without some type of antenna. The receiver is also remarkably quiet without an antenna, even with both the gain controls in the "wide open" position.

The set is remarkably stable both thermally and electrically in spite of the fact that all components above the chassis, including the tuning condensers, are too hot to touch after about 5 hours of operation. The completely shielded cabinet is almost airtight, thus preventing a free flow of air required for cooler operation.—R.F.S.

10 inch
TELEVISION
NOW **124.50**
LESS TUBES



AMAZING LOW COST

Designed by Television Training Institute of Philadelphia — where thousands of students in this and other leading television schools assemble Telekits as part of their training.

Thorough, easy-to-follow, step-by-step instruction books included with each Telekit. Pictures, schematics, diagrams and service notes.

New TTI interlock circuit for horizontal and vertical sync control—holds the picture steady even at low signal strength and at noisy locations.

High quality FM sound reception—without distortion to give you true listening pleasure.

Pre-tuned I.F. coils making alignment simple.

Switching arrangements for five bands.

GUARANTEED TO WORK—Ask your jobber about the authorized service station plan. There is one in each Television city.

Remember, No. 10 Telekit is a full ten inch television receiver kit that is comparable to commercial receivers. No. 10 cabinet \$29.50. No. 10 Tube Kit with all tubes (including 10BP4) \$64.50.

SEVEN INCH TELEKIT \$77.50
(LESS TUBES)

Number Seven Telekit is easy to assemble. Perfect set for the television beginner that is Guaranteed to receive sound and video of an excellent quality. Complete instruction books with each kit.

See the Telekits at your jobber or write for **FREE BOOKLET**.

TELEKIT

ELECTRO-TECHNICAL INDUSTRIES
121 NORTH BROAD STREET PHILADELPHIA 7, PA.

TECHNOTES

... PHILCO 37-61
Intermittent reception on strong signals may be caused by a shorted voice coil due to a warped speaker.

Re-center the cone or replace the entire speaker.

WELTZ C. HANKS,
Crowley, La.

... FORD (PHILCO) 1940-41
If severe static is encountered when traveling over rough roads, use shielding braid to bond the r.f. and i.f. shield cans together and connect them directly to the case—not the chassis—of the set. This cures the trouble every time; even when the cans are tied firmly to the chassis.

EDGAR CAMPBELL,
New Market, Tenn.

... MOTORBOATING MIDGETS
Motorboating on the low end of the dial is a common complaint on midgets and portables using loop antennas. This is often caused by feedback from the i.f. stage to the loop. Align the set.

If a glass tube is used in the i.f. stage, replace it with a metal equivalent. As a last resort, try retuning the i.f. to about 435 kc. This will do the trick in most cases.

JOHN R. SIMPSON,
Gainsville, Fla.

... STROMBERG-CARLSON 1101-H
A number of these sets were returned to our store for pilot light replacements shortly after being placed in service. Investigation showed a 5-tube circuit with a 35Z5 rectifier using dual 40- μ f condensers. We replaced the input filter with a 16- or 20- μ f unit with very little sacrifice in plate voltage (2 to 4 volts) and negligible increase in hum.

LAWRENCE N. DUNCAN,
McMechen, W. Va.

... PHILCO MODEL 42-380
If the power supply is shorted and the bias resistors overheat, look for a filament-to-cathode short in the 6X5 rectifier tube which operates with one side of its filament grounded.

LEONARD L. SMYLIE,
Vallejo, Calif.

SPECIAL VALUES



35Z5, 12SQ7,
50L6 Amplifier Complete
wired, Hi-Gain, Hi-Fi,
AC-DC amplifier
WITH
TUBES
\$4.69

Wireless Phono Oscillator
Special circuit that delivers strong output with true reproduction. Mike or phono input.
WITH TUBES **\$4.49**
& WIRED....

PEANUT AMPLIFIER
uses 35W4, 50B5 to give Hi-Amplification with good fidelity. Tone & volume controls.
WITH TUBES **\$4.25**
& WIRED....

SEND FOR ILLUSTRATED CATALOG
25% ON ALL C.O.D. ORDERS

CONSTANT ELECTRIC

112 Cornelia Street

Brooklyn 21, N. Y.

All the Science of
BASIC RADIO-ELECTRONICS
in one 3½ lb. book



ONLY
\$5
Complete

WRITTEN FOR
BEGINNERS



36 COURSES IN ONE

If this big 972-page Book were broken into monthly lessons and sold as a "course" you'd regard it as a bargain at \$50 or more!



A. A. Ghirardi's famous 972-page, 3½ lb. RADIO PHYSICS COURSE book with its 500 illustrations and 856 Self-Test Review Questions can teach you basic Radio-Electronics quicker, easier and at far less cost than you may have thought possible! It has given more people their start in Radio than any other! It is used more for home study and was more widely used in U. S. Army Signal Corps and Navy war-time training programs than any other book of its type!

START NOW!

thought possible! It has given more people their start in Radio than any other! It is used more for home study and was more widely used in U. S. Army Signal Corps and Navy war-time training programs than any other book of its type!

LEARN IN A FEW WEEKS!

RADIO PHYSICS COURSE is written for beginners who want to learn at home in spare time. Many who never even studied a circuit diagram before have completed it in a few weeks. Every basic subject is fully covered. Nothing is omitted. You'll be pleased how quickly it has your understanding subjects that other books and courses make seem too complicated. Send coupon today! Our 5-DAY MONEY-BACK GUARANTEE protects you absolutely.

"Better than a \$150 Course!"
"I had already taken a \$150 radio course," writes Gerard Champagne of Montreal. "but since reading RADIO PHYSICS COURSE, I put the other one away. Ghirardi's is the book I need because it teaches so clearly!"

NO RISK COUPON mail today

Dept. RC-107, Murray Hill Books, Inc.
232 Madison Avenue, New York 16, N. Y.

Enclosed find \$5 (\$5.50 foreign) for a copy of Ghirardi's 972-page RADIO PHYSICS COURSE book or send C.O.D. for \$5 plus postage (no foreign C.O.D.'s). In either event, if not satisfied, it is understood I may return book in 5 days for complete refund of my money.

Name

Address

City & Dist. No.

State

YOU'LL NEVER GO WRONG
on a **GHIRARDI BOOK!**

SW ROTARY ANTENNA

(Continued from page 34)

ing a nice report of S9 plus 10 db for a solid 40-minute QSO, on Saturday, of all madhouse days possibly the worst on the crowded 10-meter band.

It would be a very good idea, especially if the same type of split-center elements are used, to incorporate either tuning stubs at the middle of each element of the array, or better yet, to tune them by means of 100 µf variable condensers, as suggested and used by W6DAX on his 4-element array. Flexible rubber tubing, or plastic tubing, secured to the condenser shafts will permit tuning in a moment to an almost perfect degree, with no trouble from lop-sided elements. With such a system, one man and a field-strength meter can get more out of a beam than half a dozen could using the conventional sliding-end elements, and without the necessity of continually swinging the array back and forth during the tuning process. Tuning and element lengths, incidentally, of the 5-element system described appear to be almost identical with conventional systems. Loading was easily accomplished with a four-turn link in the center of a split-tank final.

The impedance of the system is a moot question. We figured 4 ohms would come fairly close, and wanting to try it out as soon as possible, we used 300-ohm Twin-Lead to a quarter-wave matching section consisting of paralleled, 6-foot, 72-ohm Twin-Lead. Two sections, giving a stub impedance of some 37.5 ohms paralleled, seemed to work out nicely with the 300-ohm feed line, but a tuned stub of course would be the proper method of securing a really efficient match in a duplicate installation.

For the ham who already has a 3- or 4-element job, and wishes to get that power down to an optimum angle in the quickest and easiest way this stunt of adding top and bottom reflectors is recommended. It may be useful as well to those who may be hunting for design data on the construction of an entirely new system. Its performance at the author's station, under all conditions, has definitely shown the 5-element job to outperform any other system tried, without giving us the major headache of trying to support a heavy, awkward structure of impossible dimensions on top of an average dwelling.

INTERFERENCE SUPPRESSOR?

In my radio shop, fluorescent lamps cause serious interference on my a.c.-d.c. radio. I have reduced and even eliminated the noise by plugging in my amplifier, which has a fairly heavy power transformer, with the B-plus off. In fact, any power transformer that may be lying around will reduce or kill interference by simply plugging it into the line.

E. M. CORTEZ,
San Pablo City, Philippines

Lafayette

New, Free, Full Flyer now ready . . .

Packed with spectacular bargains in Radio, PA and Ham Equipment

See the latest, greatest bargains the market offers today. Write for Lafayette's FREE Flyer C-40. It's packed to the hilt with slashing, smashing super values that have been typical of Lafayette for years. New, top quality items; speedy delivery. Send for Flyer C-40 now and save.

typical Lafayette super values!

PORTABLE RECORD CHANGER AMPLIFIER

Sturdy construction; gentle action. Latest model record changer plays a stack of 10" or 12" records. Automatic or manual operation. Built-in amplifier uses tubes: 35Z3, 50L6, 14H7. Tone and volume controls. Alnico 5 PM speaker. Smart, 2-tone leatherette case with flexible handle, and chromium fittings. 16" x 19½" x 9". Shpg. wt. 23 lbs.

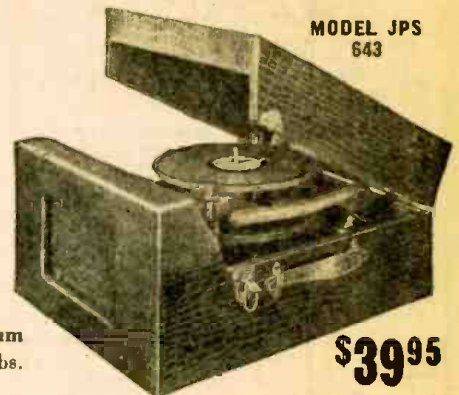

PORTABLE RECORD PLAYER MODEL JPS642

Super buy in a compact, lightweight single record player. Plays 10" or 12" records. The 5-inch speaker produces clear, undistorted tones; has built-in amplifier. Runs smoothly; featherweight, tangent-pickup holds any needle. Rugged 5-ply wood case with leatherette cover. 110 V. 60 cycle AC. 16½" x 13" x 7¼". Shpg. wt. 15 lbs. **\$17.95**

WEBSTER-CHICAGO WIRE RECORDER

Foundation Unit



MODEL 79

oscillator coil, a 15-minute spool of recording wire and an instruction sheet with suggested circuit diagram. The unit takes any standard Armour type recording spool; can make recordings up to full hour. 10½" x 8¾" x 5½" (3½" below main plate; 2" above). Net wt.: 10 lbs.

Make your own professional wire recorder at a phenomenal saving with this now famous Webster foundation unit. This is the same model used in the Webster Portable Wire Recorder. Has complete wire transporting mechanism, a triple-purpose recording head (records and plays erases back), an

Lafayette Radio

RADIO WIRE TELEVISION, INC.

100 SIXTH AVE. NEW YORK 13
542 FORDHAM RD. BRONX, N. Y.
110 FEDERAL ST. BOSTON 10
24 CENTRAL AVE. NEWARK 2, N. J.

Fill In Coupon and Mail Now

LAFAYETTE
RADIO

DEPT. JJ-7
100 Sixth Ave.
New York 13, N.Y.

Send Model No. at once. Money Order
 Rush Flyer C-40. Check enclosed

Name
Address
City Zone State

MAKE MONEY!

ASSEMBLING COIN RADIOS

Thousands of dollars have been made during the past year by wide awake radio service men who have installed coin radios in Hotels, Hospitals, Motels and Tourist Cabins. Great demand—No experience necessary.

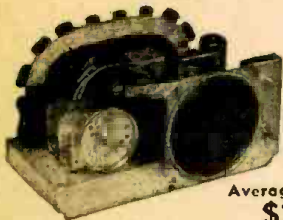
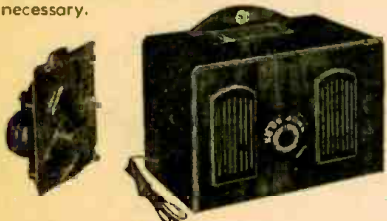

Just
3
Steps

Average Profit
\$25 Per Set

If Sold Outright
Much More If Operated on a Rental Basis!

We supply complete chassis with 6 tubes, quarter coin slot and one or two hour timer ready to place in walnut cabinet. Furnished with foolproof lock and coin box. Fill out order blank and mail to:

EICHEL ELECTRONIC CORP.
EVANSVILLE 8, INDIANA

FILL OUT... MAIL

EICHEL ELECTRONIC CORP.
EVANSVILLE 8, INDIANA

No. PLEASE SHIP ME: Amt.

Cabinets with lock @ \$6.75	
6 Tube Chassis @ \$16.50	
Timers @ \$6.50	

I understand the above three items include all the parts for your latest model coin operated radio.

Name.....

Street No.....

City and State.....

FMT ★ FM TUNER Permeability Type

A complete fully assembled, tested oscillator-mixer that tunes in the 88 to 108 MC FM broadcasts. Enjoy noise free high fidelity radio reception. FMT output feeds into usual FM I.F. amplifier which you can easily build, or into the older FM-45 receivers (I.F.) to change them to the new FM band. All parts, including tube, are combined into a single compact unit measuring only 2 3/4" x 1 1/2" on chassis, to which you connect aerial wire and three voltage wires. It works right every time. It is very sensitive to weak signals, and under favorable weather conditions has tuned in low power FM stations clearly 200 miles away. The FMT is calibrated to feed into 10.7 MC and other I.F. Introductory Price \$6.50 (less tube) postpaid. State I.P. used. Complete directions and drawing with each unit.

Est. 1922

J.-M.-P Mfg. Co.

ORDER TODAY Dept. FMT, Milwaukee 10, Wisc.

Investigations on use of radar for inland navigation are being made in Canada by a special vessel commissioned by the Canadian National Research Council.

250-WATT TRANSMITTER

(Continued from page 27)

signed, the metal type was not available. The 2 large glass tubes are the 6F6-G's. The square transformer between the two 6F6-G's and the rear of the chassis is the driver transformer for the TZ-40 modulators. The 5Z4 rectifier, the filter chokes, and power transformer for the speech amplifier power supply are shown grouped at the right of the chassis.

The small power transformer and Type 80 rectifier at the rear center of the chassis are components of a 200-volt d.c. bias supply for the final r.f. amplifier. The small pointer knob formerly controlled a bias potentiometer and switch and has no circuit function in the final design. The 6H6 tube, shown slightly to the left of the 0-1 d.c. milliammeter, is a rectifier for the percentage modulation indicator.

Construction of the speech amplifier and modulator is more or less conventional and quite simple. Unless the builder has had considerable experience with high-gain audio amplifiers, it is suggested that he adhere strictly to the design and layout as shown. No troubles from hum or instability were experienced. However, as the speech amplifier is included as a part of the complete rack assembly, it was found necessary to use a metal shield plate over the open bottom of the chassis to prevent stray r.f. voltage from entering the 6SJ7 and 6U7 input circuits. In some installations, the use of a 2.5-millihenry r.f. choke in series with the 6SJ7 control grid may be required to prevent r.f. from reaching the input circuit. The r.f. choke, however, should not be used unless it is absolutely necessary, as its windings may pick up 60-cycle hum. R.f. feedback into the speech amplifier can be minimized by shielding the bottom of the chassis and by good ground connections between the various chassis in the rack. At this time a word of caution is not amiss: *Do not depend upon the panel mounting screws for ground connection.* This is extremely dangerous as there is always a possibility of the r.f. panel having a potential difference of 1,700-2,000 volts to ground if the panel screws do not make a good connection between the panel and chassis and the cabinet. The various chassis should be connected together with flexible metal braid to which heavy duty lugs have been soldered. The lugs should be attached to the chassis with nuts and bolts; and the entire assembly, including the metal cabinet, should be connected to a good ground, such as a water system. All leads shown enclosed in dotted lines are loosely shielded by means of flexible metal braid tubing. The tubing should be grounded to the speech amplifier chassis. Keep all wiring between stages short and direct; all leads carrying 60 cycles a.c., such as the heater wiring, should be twisted together and dressed close to the metal chassis to restrict their external fields.

(Continued on page 74)

HARD-TO-GET PARTS

POWERFUL ALL-PURPOSE INDUCTION MOTOR

IDEAL FOR EXPERIMENTERS—101 USES

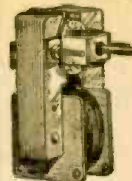

Sturdily constructed to precision standards, this self-starting shaded pole A.C. induction motor is powerful enough for a number of uses. Some of these are: Automatic Timing Devices, Current Interrupters, Electric Fans, Electric Chimes, Window Displays, Photocell Control Devices, Electric Vibrators, Small Grinders, Buffers and Polishers, Miniature Pumps, Mechanical Models, Sirens, and other applications.

Consumes about 15 watts of power and has a speed of 3,000 r.p.m. When geared down, this sturdy unit will constantly operate an 18-inch turntable loaded with 200 lbs. dead weight. **THAT'S POWER!** Dimensions: 3" high by 2" wide by 1 3/4" deep; has 4 convenient mounting studs; shaft is 7/8" long by 3/16" diameter, and runs in self-aligning oil-retaining bearings, designed for 1 to 20 volts, 50-60 cycles, A.C. only. Shp. Wt. 2 lbs.

ITEM NO. 147

YOUR PRICE

\$2.95

ULTRA MAGNET

LIFTS MORE THAN 20 TIMES ITS OWN WEIGHT
LITTLE GIANT MAGNET

Lifts 5 lbs. easily. Weighs 4 oz. Made of ALNICO new high-magnetic steel. Complete with keeper. World's most powerful magnet ever made. The experimenter and hobbyist will find hundreds of excellent uses for this high quality permanent magnet. Measures 1 3/4" x 1 1/4" x 3/4" Shp. Wt. 3 1/2 lbs.

ITEM NO. 159

YOUR PRICE

\$1.50



GENUINE MICROPHONE TRANSMITTERS



Regular telephone transmitters taken from a large telephone supply company's overstock. Work perfectly on 2 dry cells. Can be used on P.A. systems, call systems, intercommunications, etc. Short-line telephone circuits, house-to-house or farm-to-farm phone lines, also to talk through your own radio or as concealed dictaphone pick-up. Useful replacements on battery-operated rural telephone lines.

THESE ARE GENUINE TRANSMITTERS, MADE BY KELLOGG, WESTERN ELECTRIC, STROMBERG-CARLSON, excellent in appearance and operation. A remarkable value and one seldom offered in these times. Shp. Wt. 1 lb.

ITEM NO. 160

YOUR PRICE

\$2.10

AMAZING BLACK LIGHT!!

Powerful 250-Watt Ultra-Violet Source



The best and most practical source of ultra-violet light for general experimental and entertainment use. Makes all fluorescent substances brilliantly luminescent. No transformers of any kind needed. Fits any standard lamp socket. Brings out beautiful opalescent hues in various types of materials. Swell for amateur parties, plays, etc. to obtain unique lighting effects. Bulb only. Shp. Wt. 2 lbs.

ITEM NO. 87

YOUR PRICE

\$1.95

WESTERN ELECTRIC BREAST MIKE

This is a fine light-weight, air-craft carbon microphone. It weighs only 1 lb.

Mike comes with breastplate mounting and has 2-way swivel adjustment so that it can be adjusted to any desired position. There are 2 woven straps; one goes around neck, the other around chest. Straps can be snapped on and off quickly by an ingenious arrangement.

This excellent mike can be adapted for home broadcasting or private communication systems. By dismounting breastplate, it can be used as desk mike.

Comes complete with 6-foot cord and hard rubber plug. Finished in silverized plate, non-rustable. Shipping weight, 2 lbs.

ITEM 152

YOUR PRICE

\$1.49

WATTHOUR METER

Completely overhauled and ready for immediate service. Designed for regular 110-volt 60 cycle 2-wire A.C. circuit. Simple to install: 2 wires from the line and 2 wires to the load. Sturdily constructed in heavy metal case, 8 1/2" high, 6 1/2" wide, 5" deep. Westinghouse, G.E., Ft. Wayne, Sontano or other available make Shp. Wt. 14 lbs.

ITEM NO. 33

YOUR PRICE

\$7.50



HUDSON SPECIALTIES CO. 40 West Broadway, Dept. RC-10-47, New York 7, N.Y.

I have circled below the numbers of the items I'm ordering. My full remittance of \$..... (NO C.O.D. include shipping charges) is enclosed (NO C.O.D. ORDERS UNLESS ACCOMPANIED WITH A DEPOSIT.) OR my deposit of \$..... is enclosed (20% required), ship order C.O.D. for balance. NO C.O.D. ORDER FOR LESS THAN \$5.00. BE SURE TO INCLUDE SHIPPING CHARGES.

Circle Item No. wanted:

147 159 160 87 152 33

Name.....

Address.....

Please Print Clearly

City.....

State.....

HOUSEWIVES AND TELEVISION

(Continued from page 31)

berry reverently. Mrs. Hockfleisch nods approval. Vanderstupe's suggestion is immediately carried into action. The irons are discarded, and placed in the refrigerator to cool off.

Mrs. Tittleberry fingers an if. can. "Does anyone know where this resistor goes?" she asks hesitantly.

Mrs. Hockfleisch laughs heartily. "Resistor, indeed!" she cries. "Why, you silly, that's no resistor—that's a condenser!"

Helping each other in this way, the women continue their work. Mrs. Hockfleisch wires up her set carefully, making sure there is no clash of colors. Tittleberry carefully attaches the power line cord to the oscillator coil. Vanderstupe has gotten some bread crumbs into the tuning condenser, and is busy prying the plates apart with a can opener to get the particles out.

So the time goes pleasantly by. Occasionally the murmur of conversation is drowned out by the shattering of a cathode-ray tube. When the walls have stopped shaking, the women continue where they left off, while tenants in the floors above and below pick pieces of glass out of their eyeteeth.

In the evening, the ladies put aside their glue pots, can openers, and other

tools. Vanderstupe and Tittleberry depart for their respective homes. Mrs. H. eagerly awaits her husband, Montmorency Hockfleisch, greeting him proudly when he arrives.

"You'll never believe it, Montmorency, but I'm building a television set," she exclaims.

"Got supper?" asks Mr. Hockfleisch brusquely. He's had a hard day at the office. He's due for a harder night at home.

The salad is garnished with cathode-ray tube particles. The beef stew is filled with half-watt resistors.

Mrs. H. is overjoyed at finding these missing components. Mr. H., however, scarcely shares her pleasure. His sullen apathy flares into hot anger when he bites into a 10- μ f, 450-v condenser.

"Holy smoke, this is too much!" shouts Hockfleisch.

His overburdened mind gives way.

Rushing into the living room, where his wife has been playing the phonograph to drown out his anguished cries, he jumps into the automatic record changer while it is changing records, and is never seen again.

Television did it, gentle reader.

Keep it away from housewives, is our moral.

CARRIER RADIOPHONE

(Continued from page 25)

The other end of the rotating coil is connected through the back shaft to winding G, which consists of 15 turns. The end of winding G is connected to B+ through switch S-202. Windings E, F, and G are wound in 2 layers. The ANT. COUPLING rotating coil is not connected into the plate circuit; it has one side grounded and the other connected to the r.f. output jack. The 6-volt pilot lamp (r.f. indicator) is connected directly across this winding.

The M.O. and P.A. coils can be constructed by rewinding a commercial transmitting coil. Such a coil is manufactured by E. F. Johnson Co. under the numbers 661 for 20 meters, 662 for 40 meters, and 663 for 80 meters. The revolving ANT. COUPLING coil may be replaced by a fixed winding of about 16 turns located between windings E

and F. The exact number of turns and the placement of the windings is not critical.

If you prefer, the rotating coils may be eliminated entirely. In the construction of P.A. coil L203, the ANT. COUPLING may be replaced by a fixed winding of about 16 turns located between windings E and F, the P.A. TUNING coil would be eliminated and coils G and F joined directly together. The M.O. coil L201 would have windings A and B joined together in one continuous winding, and rotating coils C and D would be eliminated. The P.A. coil then would have to be tuned by a variable condenser together with C7 across it; the M.O. coil also would be tuned with a variable condenser together with C2 and C3 across it. These condensers would each have a capacitance of about 350 μ f.

Place a shield between the oscillator and power amplifier stages.

Power supply

The power supply can be constructed on either a metal or wooden chassis about 10 x 6 x 2 inches. See Fig. 4. Mount the transformer, choke, tube (Continued on page 72)

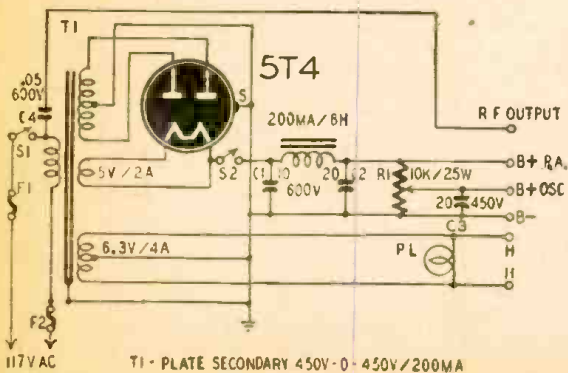
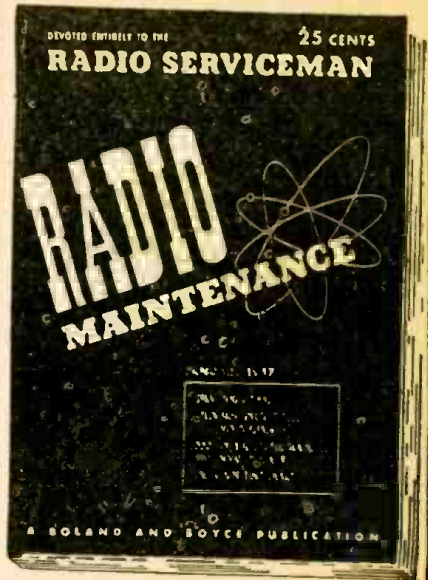

Fig. 4—The power supply. High voltage should be 450-450, 200 ma.

30,000

RADIO SERVICE-TECHNICIANS READ



EVERY MONTH

RADIO MAINTENANCE today fills a breach that has existed in the radio field for a long time. Already 30,000 servicemen read RADIO MAINTENANCE every month because it is devoted entirely to the Radio Service Technician.

The RADIO MAINTENANCE staff specializes in the preparation of articles on every phase of Radio Maintenance in series form which may be filed and used for reference. The leading articles cover everything for the radio serviceman on Television, EM and AM; Test Equipment; Electronic Appliances; Tools; Antennas; Alignment; Troubleshooting; Repair; Construction; Pick-Ups and Sound Amplification and Reproduction Equipment. Also, in RADIO MAINTENANCE each month there are departments on hints and kinks, the latest news of the trade, review of trade literature, radiomen's opinions, new products and news from the organizations. All articles are presented in a step-by-step precision style, clearly illustrated, with schematics, accurate photographs, specially prepared drawings, white on black charts, color diagrams, isometric projections and exploded views.

Special Offer Oct. & Nov. 16 issues for \$3!

Your first issue will be mailed immediately on receipt of this coupon. One issue FREE IF payment is enclosed.



RADIO MAINTENANCE MAGAZINE
460 Bloomfield Avenue,
Montclair 5, N. J.

Please send me RADIO MAINTENANCE for 16 months for \$3.

Payment enclosed Bill me later

Name

Address

City—State

Occupation

Title

Employed by

*Independent Serviceman—Dealer Serviceman—Service Manager—Dealer—Distributor—Jobber

BOLAND & BOYCE INC., PUBLISHERS

FOR BETTER BUYS SEE HIGHBRIDGE



**PULSE TYPE RADIO ALTIMETER
SCR-718**

Invaluable as aircraft or navigation aid 110 v.—400 cy. A.C. Tube complement includes 3—6AG5; 1—2X2; 1—3DP1. In perfect operating condition—schematic with each unit. Complete **\$9.80**

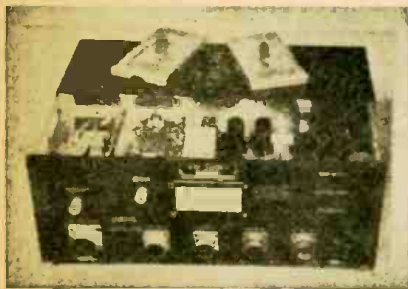

**ALTIMETER TRANSCIEVER
RT-7/APN-1**

Freq. 418-462 Mc; FM with 14 tubes: 3—12SJ7, 4—12SH7, 2—12H6, 1—VR150, 2—955, 2—9004 and 27 v 3a dynamotor. Possible uses: aerial mapping, burglar alarms, citizens' band. In case 8 1/2" x 7 1/2" x 18 1/2". Wt. 25 lbs. Used **\$8.95**

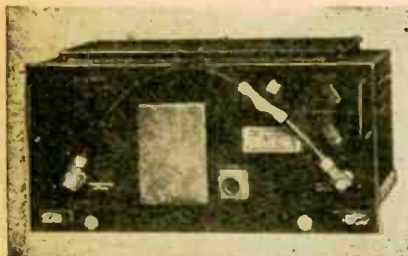

**RADIO TRANSMITTER AND RECEIVER
APS 13**

Light weight air-borne radar system. radio transmitter and receiver APS-13; tube complement 5—6J6; 9—6AG5; 1—VR105; 2—D21; unit is brand new, complete with tubes; the tubes alone are worth more than this low price of only **\$11.75**

WESTERN ELECTRIC INPUT TRANSFORMER

Video core type; Imped. ratio between windings: 1-2, 3-4, 5-6; in parallel 50-900 ohms; Freq. range 10 KC. to 2 MC; made for set AN/APQ-13; Electrostatic shield between windings, oil filled; 5 3/4" diameter, 5" high, wt. 5 lbs. **\$1.95**

BRAND NEW 7EP4

Individually packed in original cartons. Guaranteed **\$19.50**

KS-9524-TRANSFORMER

Pri. 115 v-60 cycles. Sec. #1-450 v @ 30 MA C.T. Sec. #2-6.4 v. @ 1250MA. Rectangular metal case. stud mfg. solder eyes—approx size 3 1/16 x 2 5/16 x 3 3/8 with standoff 4%. No. T2G-97 **\$1.95**

All Prices FOB New York City, N. Y.

**HIGHBRIDGE RADIO - TELEVISION
& APPLIANCE CO.**

343 Canal

New York 13, New York

CARRIER RADIOPHONE

(Continued from page 71)

and bleeder resistor R1 apart so as to provide good radiation of the heat generated. Use rubber grommets for all through-the-chassis wires. Place a fuse in both leads from the power line!

Switch S-1 is the main power switch; switch S-2 is the standby B-power switch. When the power supply is connected to an outlet, *make sure the chassis of the transmitter is not hot in respect to any grounded objects.*

The adjustable tap of the bleeder resistor should be set so that the oscillator is supplied with about 250 volts. This adjustment must be made with the oscillator load connected because the voltage drops when a load is applied. Do not try to move the tap when the screw adjustment is tight or when the power supply is on.

The power supply is designed to operate the transmitter as well as a 10-watt modulator.

Operating instructions

Switch S-201 (M.O. TUNING STEP A) roughly adjusts the frequency of the oscillator. M.O. TUNING B operates a revolving coil within L-201; it changes the frequency of the oscillator by aiding or opposing the inductance of the fixed winding. Switch S-202, which is labeled C-P.A. TUNING RANGE, turns off the B-supply voltage to the 807 tube. P.A. TUNING STEP D operates a selector switch which roughly tunes the plate tank coil by adding and subtracting turns. P.A. TUNING E rotates a coil inside of the plate tank coil; this control tunes the coil L-203 to the exact desired frequency. ANT. COUPLING H rotates the coupling coil and determines the amount of r.f. energy delivered to the power line.

Test the transmitter with the case and shield removed. If the 6L6 stage is oscillating, a neon lamp will glow when it is placed near grid or plate leads of the oscillator. The plate and screen current, as measured with a d.c. milliammeter connected through jack J1, should be about 50 milliamperes with 250 volts applied to the 6L6 if the tube is oscillating. The plate current will be about 100 milliamperes if the tube does not oscillate.

To tune the final amplifier to the frequency of the oscillator, turn on the final stage switch S-202, turn the ANT. COUPLING H to about 5, and connect the pilot lamp output indicator. Turn P.A. TUNING STEP D to each of the four positions. At one position the pilot lamp should glow. Adjust the P.A. TUNING E so that the pilot lamp is brightest. Do not advance the ANT. COUPLING control too high or you may burn out the pilot lamp.

Calibration

To stay within the recommended limits of 160 to 200 kilocycles, you should determine to what frequency the oscillator is tuned with different set-

(Continued on opposite page)



Ne-O-Lite Tester Hardware Lab. Carbon-X • Spray Kit

G-C NE-O-LITE TESTER

Handy, inexpensive Ne-O-Lite Tester that every serviceman, experimenter, etc., should have. Can be used on 60 V.A.C. to 500 V.A.C. or D.C. No. 5100—single tester on card. Only 50c each. No. 5100-D—Display of 20 testers—List \$10.00



G-C HARDWARE LABORATORY

20 clear glass jars of over 1000 essential electronic hardware items: Ideal for servicemen, etc. No. 6601. List \$12.00



G-C CARBON-X

A good method to touch up worn and noisy spots on carbon volume controls. CARBON-X is an electrical conductor. No. 1205—2 oz. bottle. List \$3.75

G-C FELT-KOAT FLOCK FINISH SPRAY KITS

Easy to supply flock for refinishing turntables, cabinets, krilles, etc. Kit contains specially designed spray gun, 2 colors flock, undercoats, thinner, brush, instructions, etc. No. 180-2—List \$10.75

SOLD BY ALL JOBBERS!
Write for our complete catalog today!
RADIO DIVISION DEPT. D

GENERAL CEMENT Mfg. Co., Rockford, Ill., U.S.A.
Manufacturers of over 3,000 products
Sales offices in principal cities

RADIO MEN

Write for Bargain Catalog of Radio Parts BUYERS' SYNDICATE

786 Carew St.

Springfield, Mass.

Get Started in Radio

10 "HOW-TO-DO-IT" BOOKS



Get a solid foundation in radio by means of these 10c timely text books. Each clearly written, profusely illustrated, contains over 15,000 words. You'll be amazed at the wealth of information packed into these handy books. Excellent for reference—ideal for technical library. Your money back if not satisfied.

**5 BOOKS for 50c
10 BOOKS for \$1.00**

Sent to You Postpaid

No. 1—How To Make Four Dozier Short Wave Sets
No. 2—How To Make The Most Popular All-Wave 1 and 2 Tube Receivers
No. 3—Alternating Current for Beginners
No. 4—All About Aerials
No. 5—Beginners' Radio Dic.
No. 6—How To Have Fun With Radio
No. 7—How To Read Radio Diagrams
No. 8—Radio for Beginners
No. 9—Simple Electrical Experiments
No. 10—Television
Remit by check or money order—regulator letter if you send cash or stamps.

RADIO PUBLICATIONS

25A West B'way,

New York (7)

MARKING TERMINALS

To mark terminals either on strips or tube sockets, I use white ink for lettering and coat it with clear nail polish or lacquer for a durable protective covering. An Artgum eraser is useful in removing any dirt or oil film from the surface before the ink is applied.

**R. E. BLAYLOCK,
Little Rock, Ark.**

tings of the vernier dial M.O. TUNING B and selector switch M.O. TUNING STEP A. This can be done with sufficient accuracy if a broadcast receiver with true calibration is available. Several harmonics from the transmitter will fall within the broadcast band. By noting the frequencies of these harmonics with each setting of M.O. TUNING B, it will be possible to calculate the frequency of the transmitter. Since the harmonics are integral multiples of the fundamental, the difference between two adjacent harmonics will equal the frequency of the fundamental. The range of the transmitter will be about 160 to 270 kilocycles. Before calibrating, replace the shield and case. This is important because the frequency will certainly shift when the shields are put in place.

When you choose the frequency on which to operate, keep in mind these harmonics that fall on the broadcast band. Adjust your frequency so the harmonics will fall between broadcast stations where they will not cause any interference with broadcast reception in neighboring receivers. Also, keep the ANT. COUPLING H at the lowest setting that will maintain communication. Signal strength may often be increased by connecting an .05-uf condenser between chassis and the grounded side of the line.

Provisions are made for cathode keying through jack J2 on the front panel.

The second part of this article will describe the construction of an inexpensive 10-watt modulator for carrier-current phone operation and a simple carrier-current receiver, which can be used in conjunction with this transmitter. It will appear in an early issue.

AIR DRYER

Crystal pickup cartridges, paper condensers, phonograph records, and other parts easily damaged by moisture or mold, particularly in humid climates, can be preserved for long periods by placing them in a cabinet having a circulating draft of warm air. Install a 8- to 10-watt electric heater unit, like those designed for use in incubators, in the bottom of the cabinet. The continuous circulation of warm air will prevent moisture from condensing on any surface in the cabinet. Use 2 units in parallel if the air is too cold, and in series if the air is too hot.

Electric lamps may be used, but they are less efficient and require more power.

R. DEL VALLE SARROGA,
Santurce, Puerto Rico

EASY TO LEARN CODE

It is easy to learn or increase speed with an Instructograph Code Teacher. Affords the quickest and most practical method yet developed. For beginners or advanced students. Available tapes from beginner's alphabet to typical messages on all subjects. Speed range 5 to 40 WPM. Always ready—no QRM.

ENDORSED BY THOUSANDS!

The Instructograph Code Teacher literally takes the place of an operator-instructor and enables anyone to learn and master code without further assistance. Thousands of successful operators have "acquired the code" with the Instructograph System. Write today for convenient rental and purchase plans.



INSTRUCTOGRAPH COMPANY

4701 Sheridan Rd., Dept. RC, Chicago 40, Ill.

Metropolitan

NO LOWER PRICES ANYWHERE!

The Model 689-IF WESTON OHMMETER



A convenient, pocket size ohmmeter for checking circuits by the resistance and continuity method. The energy for the resistance readings is supplied by a self-contained 1.5 volt No. 2 standard large flashlight cell. Built to meet U.S. Army Requirements for Accuracy and Durability!

This Ohmmeter also has a double range 0-10 and 0-1000

ohms for the accurate measurement of low resistance values. Model 689-IF comes complete with operating instruction, test leads and LEATHER CARRYING CASE. List price \$25.50 Our Price **\$14.85**



The New Model 111 AC-DC QUALITY MULTIMETER

A new pocket-size volt-ohm-milliammeter with features never before available in an instrument of this size and price.

D.C. Voltmeter: 0.5-50-250-500-2500 volts, A.C. Voltmeter: 0-10-100-500-1000 volts, Output Voltmeter: 0-10-100-500-1000 volts, D.C. Milliammeter: 0-1-10-100 milliamperes, D.C. Amperes: 0-1-10 amperes, Ohmmeter: 0-500-100,000 ohms; 0-1 megohm, Decibel Meter: -8 to +35 db. The scale is calibrated for line

of 500 ohms impedance. (Ion charts are supplied.) For other impedances correction charts are supplied. Model 111P, in portable case (not illustrated) including testing leads and complete instructions **\$19.85**

Model 111A, open face, as shown, complete with instructions **\$16.85**

The New Model B-45

Battery
Operated

SIGNAL
GENERATOR



for servicing AM, FM and Television Receivers. R.F. frequencies from 150 Kilocycles to 50 Megacycles (150 Kc. to 12.5 Mc. on Fundamentals and from 11 Mc. to 50 Mc. on Harmonics). Complete with shielded test lead, self-contained batteries and instructions. Net **\$27.75**

The New Model 680 5000 Ohms Per Volt VOLT-OHM MILLIAMMETER

Net Price **\$19.75**

D. C. Voltages to—1500 volts.
A.C. Voltages to—1500 volts.
Resistance to 2 Megohms. Output
Volts to—1500 volts, D.C.
Current to—150 Ma. Decibels to— + 58 D.C.



We carry nearly 5,000 instruments in stock. All models listed below are available for immediate delivery.

PRECISION APPARATUS INSTRUMENTS

832S—31 Range AC-DC Multi Range Tester	\$23.04
844P—34 Range AC-DC 600 Volts AC and DC VOLT-OHM MILLIAMMETER	32.20
858—20,000 ohms per volt Multitester	47.95
856P—44 Range Super-Sensitive, 600 volts AC-DC TESTER 20,000 ohms per volt DC	49.94
864-AC-DC VOLT-OHM-DECIBEL-MILLIAMMETER with large 9" meter	59.66
912I—Dynamic Mutual Conductance Tube Tester	61.20
E 200—A.M.—F.M. and Television Signal Generator	64.15
EV-10P—6000 volts AC and DC Vacuum Tube Multi-Range-Meter	71.81
920P—Combination Dynamic Mutual Conductance Tube Tester, Battery Tester and 33 Range AC-DC Multi-Range Set Tester	84.20
954I—Combination Mutual Conductance Tube Tester, Battery Tester and 37 Range Super-Sensitive AC-DC Multi-Range Set Tester, 20,000 ohms per volt DC	99.20

RADIO CITY PRODUCTS

447-Multi-Tester	\$17.95
448-Multi-Tester	24.50
322-Dynoptimum Tube Tester	41.50
461-P-Sensitive Multi-Tester	42.63
684-Electronic Multi-Tester	45.00
705-Signal Generator	49.50
315-Rolchart Tube Tester	59.50
802N-Combination Tube & Set Tester	59.50
668-V.T.V.O. Capacity Meter	73.01
805-Combination Tube & Set Tester	89.50
665A-V.T. "Billionaire" Insulation Tester plus VTVM	92.61

SUPERIOR INSTRUMENTS

CA-11—Signal Tracer	\$18.75
870—Super Meter	28.40
CA-12—Audible-Visual Signal Tracer	34.85
450—Tube Tester	39.50
411—Signal Generator	48.75
400—Electronic Multi-Tester	52.50
600—Combination Tube & Set Tester	62.50

SHALLCROSS MFG. COMPANY

Decade Resistance Boxes	\$13.50
Portable Galvanometers	27.50
630—Wheatstone Bridge	75.00
637—Kelvin Wheatstone Bridge	100.00
638-2-Kelvin Wheatstone Bridge	150.00

SUPREME INSTRUMENTS

543-Multi-Tester	\$18.95
589-Tube and Battery Tester	48.95
589-Tube and Set Tester	62.50
585-Vacuum Tube Voltmeter	63.50
576-Signal Generator	68.95
804-Combination Tube and Set Tester	89.50
546-Oscilloscope	89.75

McMURDO SILVER CO.

905-"Sparx" Dynamic Signal Tracer	\$39.90
904-Capacitance Resistance Bridge	49.90
900-"Vornax" Vacuum Tube Voltmeter	59.85
906-A.M.-F.M. Signal Generator	89.90

This Month's Specials

BLILEY Crystal Controlled Signal Generator	69.50
209—Electronic Measurements Mutual Conductance Tube Tester	49.85
570—Premier Micro-Master Band Spread Dial Signal Generator	54.75
MONITOR Crystal-Controlled Signal Generator	57.50
WATERMAN "Pocket" Oscilloscope	55.00
DUMONT 274-5 inch Oscilloscope	115.50
DUMONT 208-5 inch Oscilloscope	235.00
VM Mixer Record Changer	16.85
McGuire Record Changer	14.95
7" TELEVISION KIT, complete, less tubes	89.95
7" TELEVISION KIT, complete with tubes	129.95
10" TELEVISION KIT, complete, less tubes	124.50
10" TELEVISION KIT, complete with tubes	189.50

Write For Details
About New Metropolitan
Time Payment Plan

ORDERS FILLED SAME DAY RECEIVED!

TERMS: 20% Deposit, Balance C.O.D. Or Full Payment with Order.

SEND FOR FREE CATALOG

We repair all types of testing instruments. Write for information.

Metropolitan ELECTRONIC & INSTRUMENT CO.

Dept. C-10, 42 WARREN STREET Cable Address: METRONICS
NEW YORK 7, N. Y., U. S. A. Phone: Barclay 7-5556

\$351⁰⁰ VALUE



RECEIVER TRANSMITTER

FREE A COMPLETE SET OF TRANSMITTING AND RECEIVER TUBES WORTH \$35.00

FREE 1-200 KC CRYSTAL
BC-654-A is a combined transmitter and receiver designed for portable or vehicular operation. The frequency range of both transmitter and receiver is continuous from 3700 to 5800 kilocycles; all stages are tuned by anti-back lash worm gear dial mechanisms.

25 WATT
POWER
COVERS
3800 Kc To 5800 KC

**YOUR
PRICE**

\$14.⁵⁰

A WIRE BUY \$33.⁰⁰

No. 10-7 Strand Black Plastic Indoor or Outdoor Wiring on 27" reel—15,000 ft. \$270.00 Value. Your Price..... Lifetime Covering 100 Uses

\$33.⁰⁰

HEAVY DUTY POWER TRANSFORMER

"The Buy of the Year"
3 Primary Windings
110v—120v—125v
Taps on Primary
65-70-72v.
Secondary Windings of
500v—5v—6.3 volts
Size 4 1/4 x 4 1/4 x 3 1/4

NOW ONLY \$3.95



MALLORY LINE NOISE FILTER
Rating 110-220 V. (AC-DC)
\$10.00 Value.
Your Price..... \$3.75
In Lots of 10—\$3.25

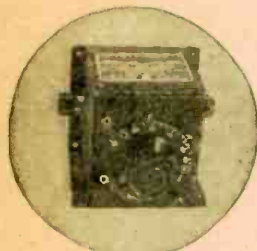

FREQUENCY METER

Calibrated on Vernier Dial 80- to 800-Mc.
\$25.00 Value. Your Price **\$4.95**
In Lots of 10—\$4.50

All Prices F.O.B. N.Y.C.—20% deposit, Bal. C.O.D.

**MANUEL KLEIN 74 CORTLANDT STREET
NEW YORK 7, N. Y.**

FREE

UP TO THE MINUTE
BUYING
INFORMATION



Radio Repair Parts
Sound Systems • Tools
Kits • Phono Equipment
Tubes • Test Instruments
Experimenters Supplies

REGULAR SUPPLEMENTS KEEP YOU POSTED

Catalog sent immediately upon request. Price and Data Supplements, issued regularly, assure you of up-to-the-minute information—give exact and current data you need for profitable buying. Send the coupon today for this helpful buying service.

**BIG VALUES, LARGE STOCKS,
FAST, DEPENDABLE SERVICE.**

FREE... SEND TODAY

RADOLEK CO., Dept. C131
601 W. Randolph St., Chicago 6, Ill.
Please send your Free Profit Guide Catalog and regular Supplements.

Name.....
Address.....
City..... Zone..... State.....

SAVE AT RADOLEK

S.S.S.

"Servicing by Signal Substitution"

Learn about this modern dynamic approach to radio servicing with ONLY BASIC TEST EQUIPMENT.
... Fully described in a 120 page book available from your Precision Distributor or factory of 35¢.
... Schools are invited to inquire regarding quantity orders from our Educational Division.

PRECISION

APPARATUS COMPANY INC.
ELMHURST 4, N. Y.
Manufacturers of Fine Test Equipment
RADIO • TELEVISION • ELECTRICAL • LABORATORY

Brand New Navy Surplus HI-FI PUSH-PULL AUDIO OUTPUT TRANSFORMER

Made for E. H. Scott's Navy Model REE entertainment receiver. Imp: pri 4400 ohms ct; sec's 4, 60 ct, 200, 300, 600 ohms. Fully cased, 5 lbs. Matches push-pull 6L6's, 25L6's, 50L6's. Tested at 18 watts power output into 4 ohms load. O.K. Excellent transient response; with 1,000 cps square wave input at 20 watts, input and output waveforms look exactly alike on scope. Can also be used for remote speakers, 600 ohms winding to line, 4 ohms to voice coil. 60 ohms winding used to provide inverse feedback voltage. With each order will include schematic of the REE's power supply and audio section which is flat (± 2 db) 70-10,000 cps. (The 70 cps figure is not due to the transformer, which is flat down to 20 cps. Tell your friends about this ad. Quantity limited. Order immediately!

Only \$1.89 each!

Please remit with order. Shipping wt. 6 lbs. for 1, 11 lbs. for 2, etc. Include reasonable amount for parcel postage, will refund excess.

GOODHEART
2616 N. Spaulding Ave. Chicago 47, Ill.

250-WATT TRANSMITTER

(Continued from page 70)

Before placing the speech amplifier in the transmitter rack or connecting it to the TZ-40 modulators, test it with an audio-frequency signal. The simplest test is to connect a PM dynamic speaker having an output transformer with a primary impedance of from 5,000 to 10,000 ohms across the secondary winding of the class-B driver transformer and to feed an audio signal into the microphone jack. Better results will be obtained if a record player, using a crystal pickup cartridge, is used to supply the audio test signal. When using a record player, however, it is necessary to connect a 10,000-to 20,000-ohm fixed resistor across the output leads from the crystal cartridge for tone compensation; otherwise the reproduction will sound tinny, and a false impression of the audio-frequency response characteristics of the amplifier will be obtained. The microphone has entirely different characteristics, and the tinny effect will not be present.

As mentioned above, inverse feedback is employed in the 6F6-G class-A driver stage. As the schematic (Fig. 1), shows, the feedback circuit is composed of two 4- μ f, 600-volt d.c., oil-filled capacitors and two 5,000-ohm, 10-watt fixed resistors. The 2 resistors are connected in series between the two 6F6-G screen grids, with the center junction connected to the center tap on the driver transformer primary and B-plus. A 4- μ f capacitor is connected from each TZ-40 grid to a screen grid of the push-pull 6F6-G tubes. The exact connection will depend upon the direction of the 2 windings of the driver transformer. Do not, under any circumstances, connect the driver transformer to the TZ-40's, with plate voltage on the modulator tubes, until the correct phasing of the feedback circuit has been established. With the loudspeaker connected to the driver transformer secondary, as described above, and with the audio gain and compression controls in the OFF position, reverse the connections of the 4- μ f capacitors and the secondary winding. In one position the 6F6-G's will oscillate at about 300 cycles and the tone will be heard in the loudspeaker; a reversal of the connections will stop the oscillations. The position in which no oscillations are heard is the correct one for inverse feedback action. If this precaution is not observed, the oscillations may be strong enough to drive the plate current of the TZ-40's sky high and damage the modulator tubes or the modulator transformer.

It will be found that the speech amplifier gain control for average voice range microphones, such as the Turner 22-X, will run about three-fourths of the way up for proper excitation to the TZ-40's.

The next installment of this series will deal with the modulator, adjustment of the compression circuit, the modulation percentage indicator and the monitor.

FIELD STRENGTH METER

(Continued from page 22)

teries have changed value and should be checked and replaced, if necessary.

To operate the unit as a field-strength meter, a short length of stiff wire or tubing is connected to the antenna post. The signal is tuned in with the TUNING control coupled to capacitor C1. The unit is of course most sensitive at resonance; but if the signal is too strong, relative measurements may be made at an off-resonant point. If



There is very little under-chassis wiring.

the signal does not give a large enough deflection, a longer antenna may be connected in series with a capacitor and the case grounded. The series capacitor is necessary to prevent serious detuning. This is often necessary when the unit is used as a monitor at some distance from the transmitter, or a doublet antenna may be connected to the primary winding.

Also a frequency meter

By using an accurately calibrated receiver as a standard the unit can be calibrated as a wave meter, for which purpose the same antenna must always be used. The unit is particularly handy when building a transmitter. The primary winding is included for this reason. A twisted-pair feeder is connected to the tip jacks and a coil connected to its free ends is coupled to the circuit under test.

When using the unit as a vacuum-tube voltmeter, be certain that a d.c. path for the grid bias is provided by the circuit under test.

A filament transformer, a potentiometer, and an a.c. voltmeter are used to calibrate the unit as a vacuum-tube voltmeter with a basic range of about 5 volts. A graph of a.c. vs. d.c. voltages reading can be plotted, or the meter scale can be calibrated directly. The range and sensitivity of the unit are sufficient for all practical problems. The range may be increased if desired with a high-resistance voltage divider of the correct size for the range required.

REPAIR RADIOS THIS FAST, EASY WAY!

Complete, easy instructions for diagnosing and repairing common troubles in practically every home and car radio in use today

ONLY \$5



NOT A STUDY BOOK!

You don't have to be an expert! You don't have to have a lot of costly test equipment to repair most radios—NOT when you have A. A. Ghirardi's famous RADIO TROUBLESHOOTER'S HANDBOOK at your fingertips. Bothered with "fading" on a certain model? "Noises" on another? "Poor volume"? A "dead" set or whatnot? Just look up the receiver's make and model in the 404-page Case History Section of the HANDBOOK. Nine times out of ten, it will tell you EXACTLY what the trouble is—EXACTLY how to fix it. No lost time! No needless testing! The HANDBOOK tells you—automatically!

WORK TWICE AS FAST ON 4 JOBS OUT OF 5

Over 300 additional big manual-size pages contain other invaluable radio service data—Color Codes, Tube Data, Tube and Part Substitutions, I-F alignment and Transformer information and literally dozens of charts, graphs, diagrams, data and helpful hints that will help you repair any radio ever made EASIER, BETTER and TWICE AS FAST! Weighs over 4 lbs. Only \$5—and you actually don't risk a cent. 5-DAY MONEY-BACK GUARANTEE.

PAYS FOR ITSELF FIRST TIME YOU USE IT!

RADIO TROUBLESHOOTER'S HANDBOOK will pay for itself in time saved the first time you use it! "Thanks to the HANDBOOK, I repaired my radio an hour after it had been returned as 'unrepairable' by a local radio shop," writes J. L. Fizzell of Kansas City. "The Case Histories take you right to the trouble and save hours of testing," says Julius Siske, Jr., of Maryland.

ONLY \$5



Prepare for a Real Future in PROFESSIONAL RADIO-ELECTRONIC REPAIR WORK

LEARN AT HOME...without an Instructor

Who will service the millions of new radios and complicated television, F-M and facsimile equipment to be sold within the next few years? Who will install and service the countless electronic devices now going into industry? Never before has there been such a demand for professionally-trained technicians who know their stuff—and this means training of exactly the type that A. A. Ghirardi gives you in his big 1300-page, profusely illustrated MODERN RADIO SERVICING. It is the ideal book for home study! Explains all types of service test instruments—how to use each one; how to make preliminary trouble checks; how to analyze circuits scientifically; how to troubleshoot; how to repair or replace parts or make substitutions; how to install equipment—and literally hundreds of additional subjects including How to Start and Operate a Successful Service Business of Your Own. Sold on 5-DAY MONEY BACK GUARANTEE. You can't lose. Send coupon today!

MAIL ORDER...Rush Coupon Now!

Murray Hill Books, Inc., Dept. RC-107
232 Madison Ave., New York 16, N. Y.

- Enclosed find \$..... for books checked; or
 send C.O.D. (no foreign C.O.D.'s) for this amount plus postage.
It is understood I may return the books for refund within 5 days if not satisfied.
- RADIO TROUBLESHOOTER'S HANDBOOK \$5 (\$5.50 foreign) MODERN RADIO SERVICING \$5 (\$5.50 foreign)
- MONEY-SAVING COMBINATION OFFER: Both big books, over 2040 pages of the finest service data—only \$9.50 for the two (\$10.50 foreign).

Name

Address

City & Dist.

GET BOTH BOOKS AT A BARGAIN

SPECIAL OFFER!

Let Ghirardi's RADIO TROUBLESHOOTER'S HANDBOOK save you time and money on common radio service jobs—let MODERN RADIO SERVICING train you for complete professional, electronic service training!—Get BOTH BIG BOOKS at the special price of only \$9.50 for the two. Use coupon. Check "MONEY-SAVING COMBINATION OFFER."

5-DAY MONEY-BACK GUARANTEE

AN/ART-B COLLINS



AUTO TUNE TRANSMITTER

A modern, compact, lightweight, high-powered transmitter. For frequency range 2-18 Mc. on any of its 11 auto tune crystal controlled or master oscillator channels. These units removed from planes. Checked and guaranteed. Weight, 67 lbs.

\$100.00

COMPLETE WITH DYNAMOTOR UNIT

**NAVY-CRV-46151
AIRCRAFT
RADIO
RECEIVER**

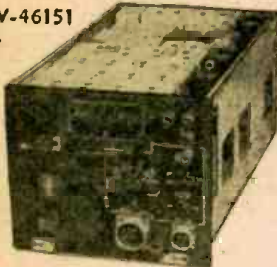

INCLUDING CASE

\$297.50

Four bands, including broadcast (195-9,050 KC). Circuit is six-tube superheterodyne with mechanical band change or remote operated electrical band change. Remote band change and tuning controls included, making this set readily adaptable to mobile ham use. Powered from self-contained 24 V. DC dynamotor.

The sets are complete with tubes, mounting rack and remote controls.

**ARC-4 TRANSMITTER
AND RECEIVER**

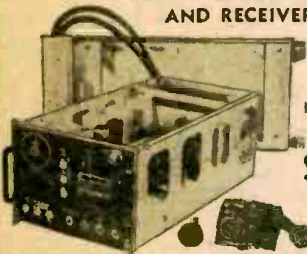

INCLUDING CASE

\$397.50

Operates on any of its 4 predetermined crystal controlled frequencies in the range of 140 MC. Complete with tubes, remote control, junction box, shock mounting base and connecting plugs. This unit is ideal for amateur UHF or mobile telephone. Operates from self-contained 24 V DC dynamotor. 12 V available upon request.



RADIO ALTIMETER APN/1

A complete 460 mc. radio receiver and transmitter which can be converted for ham or commercial use. Tubes used and included: 4-125H7, 3-125J7, 2-6HG, 1-VR150, 2-955, 2-9004. Other components such as relays, 24 V dynamotor, transformers, pots, condensers, etc., make this a buy on which you can not go wrong. Complete as shown in aluminum case 18"x7"x7 1/4"

\$14.95

TERMS: CASH WITH ORDER

**AMERICAN SURPLUS
PRODUCTS CO.**

537 N. CAPITOL AVE.
INDIANAPOLIS, IND.

**Use A
MODEL 6**



**KILOVOLT FOR YOUR
TELEVISION POWER SUPPLY**

4000-6000
VOLTS D.C.

WRITE FOR
FOLDER

\$17.95

SEND CHECK, M.O.
OR SEE DEALER

- * IT'S SAFE
- * SAVES TROUBLE
- * SMALL 4x6x6: 2 LBS.

C. B. Mfg. Co.

412 W. 37 St. N. Y. 18. N. Y.

TRANSATLANTIC NEWS

(Continued from page 38)

tenna shows a mid-point voltage about 6 db less than that of a vertical half-wave dipole. But the metallic parts of buildings, such as gutters, water pipes, and electric wiring conduits, often completely change the polarization of the incoming signal by re-radiation. Further, the polarization of a v.h.f. signal may vary from time to time, as it does at my home. The relative inefficiency of the inverted V is thus largely offset by its indifference to the polarization of the signals with which it is dealing. Mounted on a 40-foot mast out of doors, or attached to a pole clamped to a chimney, it gives satisfactory and constant results. Its directional qualities are of real value in eliminating ghosts and interference which would otherwise be caused by man-made static. Television and other v.h.f. enthusiasts may find an antenna of this type well worth trying.

New Swedish broadcasters

Sweden is soon to have 2 of the world's most powerful short-wave broadcasting stations. The transmitters are now being manufactured in England. They are scheduled for delivery within the next 12 months, and both stations should come into operation early in 1949. They will be situated at Hörby, near Malmö, in the extreme south of the country. One is to be used for omnidirectional broadcasts, and the other will have a new type of antenna system so designed that the transmissions can be beamed in any direction.

Radar and coal

Nearly all the coal used by London's electricity and gas generating stations is transported by sea from the great mining areas in the northeast of England. The ships carrying it steam close to the coast through the North Sea which, in winter, is liable to be blanketed by very dense fogs. Until recently there was nothing for it but to lie until the fog cleared away. It was indeed fortunate that before the terrible coal crisis of last winter some of these ships had been fitted to use the Decca navigational aid system; otherwise our homes would have been even colder and darker than they were! Nearly all the ships are now using it. It will undoubtedly be of great assistance in enabling coal transport by sea to continue in all weathers during the shortage which is bound to occur in the coming winter. Readers are no doubt familiar with the Decca system, which is different from either Gee or Loran, though like both

BA BARGAIN SPECIALS

**The FINEST
in HEADPHONES**



Type P23. The Choice of the Air Corps headphones, highly sensitive, 8000 ohm impedance, bipolar magnets. Extremely comfortable sponge rubber ear cushions — stainless steel leather covered headband — concealed terminals — Six Foot Cord with PL55 plug. EVERY ONE BRAND NEW in Original Factory Cartons.

Stock No. 5A134 \$13.50. value. **\$2.95**
An Outstanding Buy, Only



**12 1/2 Ft. ANTENNA
TELESCOPES DOWN
to 1 Foot 4"**

"Just it" for mobile equipment, portable receivers and transmitters. Ruggedly constructed—smooth telescopic action from 16 inches to 12 1/2 feet. Base is 3/8" in dia. with 3/8" threaded shank. By adding eyelets it makes an ideal compact fish pole. An Outstanding Value **\$1.95**
No. 38A39, Only

ORDER NOW, from this ad Add Postage

BA BURSTEIN-APPLEBEE Company
1012-14 MCGEE STREET,
KANSAS CITY 6, MISSOURI

BONAFIDE VALUES



**SHURE
T1TB**

Push Button
Carbon Mike

98c

With Cord
and Plug
Value \$12.00

**SHURE
CRYSTAL
MIKE**

\$6.95

With Stand.
Base and
7 Ft.
Cable
Value
\$18.50



- Detrola Record Changer \$14.69
- Webster 56 with Automatic Stop 25.95
- Seeburg 2 Post Changer 21.97
- Maguire 2 Post. Changer, Automatic Stop 11.95
- G.I. or Alliance A.C. Motor 2.95
- Astatic L 70 Crystal Pickup 1.95
- 5" PM Alnico Speaker 1.39
- 2 1/2" Heavy Blue Speaker—Nylon Cone 1.98
- 2" Heavy Slug Speaker or Mike Comb. 1.39
- 1/2 Meg. Vol. Cont. & Sw.—Lots of 649
- Federal Selenium Rect.—100 Mill.—Lots of 669
- 100 IRC Resistors Assorted Sizes & Watts 1.79

BONAFIDE RADIO CO.

89 1/2 Cortlandt St., Dept. C, N. Y. 7, N. Y.

of these it uses lanes composed of hyperbolic lines. It has proved peculiarly satisfactory for use at sea; and at the recent international meeting in New York on radio-aids to navigation, the U.S.A. and Britain jointly put forward a resolution, which was accepted unanimously, that its adoption should be world-wide.

Olympio radio show

The Radio Exhibition, which is to be held at Olympia, London, from October 1 to 11, will be the first in 9 years. The 1939 show was wiped out by the outbreak of the war on September 3 of that year, and since the end of the war labor and material supply conditions have been too chaotic to justify anything like a Radiolympia. Things have settled down a little now, and this year's show should be particularly interesting. The intention of the organizers is to run it on entirely new lines. Many people feel that the reforms suggested are long overdue. In the past the exhibition was of far too popular a nature: it concerned itself too much with the entertainment side of broadcasting and too little with technical radio developments. It was by no means unusual to find a stand staffed entirely by salesmen, with no one available to give intelligent answers to queries about the technicalities of the exhibits. This year there is to be a big change. It is realized that hundreds of thousands of men and women received radio and radar training in the armed forces and that they are interested now in the wider aspects of radio. For that reason the show has been thrown open to manufacturers of all kinds of electronic equipment and is no longer confined to apparatus used for broadcast reception. Among the radio exhibitors will be the General Post Office (which conducts our telephone and telegraph services), the Police, Cable and Wireless, the Ministry of Civil Aviation, and 23 firms specializing in electronic and communications equipment.

Meteors and radar

For some time now a continual radar watch on meteors has been maintained at the experimental station of Manchester University. One of the most important features of these observations is that they detect meteors arriving in daylight, which cannot be seen by the eye. This summer a completely unexpected phenomenon has been observed: during the months of May, June, and July the earth passed through a very dense stream of meteors, which reached it on its daylight side and would have passed undetected but for radar. The meteors were counted and the figures are surprising. During the showers of meteors which we see by night at certain times of the year the number of arrivals seldom average more than 20 an hour, though it may rise to 40 to 50 an hour at peak periods. These daylight meteors never fell below 20 to 30 an hour during the whole 3 months, and there were many periods during which 80 to 90 an hour were recorded.

SELENIUM RECTIFIER

When replacing a rectifier tube with the new selenium rectifier disc, mount the unit and the small resistor that it is often necessary to use with it in a tube base with the required connections soldered directly to the base pins.

AL GOODELL,
College Station, Texas

RADIO-CRAFT for OCTOBER, 1947

ENGINEERED FOR EFFICIENT FM AND TELEVISION RECEPTION

Magic Wand Aerials for FM and television offer electrical efficiency possible only through the enthusiastic teamwork of Ward's top-drawer experimental laboratory, and production facilities.

As the world's largest producer of aerials for car and home, Ward also is pioneering in educating 33 million present, and prospective, FM and television receiver owners that a good outdoor dipole antenna is necessary if quality reception is to be enjoyed. Watch for our hard-hitting ads in the Saturday Evening Post and leading newspapers.

In addition to developing outstanding FM, television and automotive aerials, Ward also has design and production capacity available to take care of special aerial needs. Submit your aerial problems to us now for an efficient, and economical, solution.

As Advertised in the Saturday Evening POST

WARD Magic Wand FM AND TELEVISION AERIALS

THE WARD PRODUCTS CORP.
1523 E. 45th Street, Cleveland 3, O.
Division of The Gabriel Company
EXPORT DEPT.: C. W. Brandes, Mgr.,
4900 Euclid Ave., Cleveland 3, O.
IN CANADA: Atlas Radio Corp.,
560 King St., W., Toronto, Ont.

WORLD'S LARGEST MAKER OF AERIALS FOR CAR AND HOME

Get a new UNGAR ELECTRIC SOLDERING IRON FREE

... and assemble your own MAGI-KLIPS

Radio & Electronic Experimenter's Kit



This is the same MAGI-KLIPS Kit—complete with all parts—that we sell ready assembled for \$29.75.

In knocked-down form with full instructions for assembly, it is now available at the new—low price—

\$19.75

... complete with an Ungar Electric Soldering Iron—the ideal iron for wiring your un-assembled MAGI-KLIPS Kit.

Remember, you build 18 different experiments with your MAGI-KLIPS Kit. You actually teach yourself radio and electronics and have a lot of fun at the same time.

RADIO RECEIVER, HOME BROADCASTER, PHOTO-ELECTRIC RELAY, CODE PRACTICE OSCILLATOR, SIGNAL TRACER, REMOTE CONTROL RELAY, Phonograph Transmitter, Intercommunication Amplifier, Code Transmitter, Radio Frequency Oscillator, Telephone Line Amplifier, Electronic Switch, Phonograph Amplifier, Temperature Control Relay, Contact Detector, Electronic Metronome, Interval Timer (one-shot), Interval Timer (repeating).

Send for your copy of FREE booklet, "Electronics Made Easy."

DEER & TAYLOR COMPANY

Dept. C 1340 Milvia St. Berkeley 9, Calif.

FEDERATED BRINGS YOU VALUES

18 Drawer EQUIPTO Steel Shop Cabinets



A remarkable useful assembly contains 18 drawers, each having four removable and adjustable compartments similar to illustration shown above. Olive green baked enamel finish, width 34", height 13 1/2", depth 12". Cabinets may be stacked or used individually. Price **\$24.50**



CRYSTAL MIKE SPECIAL!

Here's a HOT value for YOU! High quality crystal mike, for ham work, home recordings, public address, etc. Can be used either as hand mike or desk mike. Hand mike slips out of base with one twist. Handsome brown lacquer finish. Equipped with 7-ft. R.C. cable. All Yours for **\$3.95** only

Please include 25% Deposit with Order. Balance C.O.D. DEPARTMENT 29-A

Federated Purchaser
INCORPORATED
distributors of RADIO-ELECTRONIC and SOUND EQUIPMENT

80 Park Place, N. Y. 7
Phone: DIgBY 9-3050



As headquarters for Extra Special Deals on Used Test Equipment you'll always find us prepared to furnish what you want at a price you want to pay. Write us for current list of available Used Equipment at rock bottom prices.

All Prices F.O.B. St. Louis, Mo.

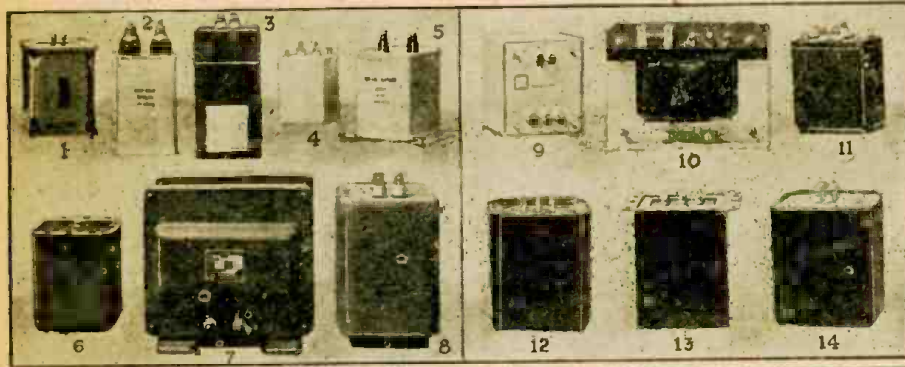

Look at these Bargains in Surplus Chokes, Transformers and Condensers

- | | |
|--|--|
| 1 FILTER CHOKE
12 HY at 200 MA. 200 ohms DC Res. Steel Case \$3.50 | 8 FILTER CHOKE
8 HY at 500 MA. 55 Ohms DC res. Very high quality. Hermetically sealed. No. 8056. Net \$11.85 |
| 2 TRANSMITTING FILTER CONDENSER
2 Mfd. 5000 VDC. Dykanol. regular net price \$29.63. Our low bargain price \$7.51 | 9 PLATE TRANSFORMER
2500 VCT. 150 MA. Pri. 115 VAC. 60 CY. Steel case with stand-off insulators. No. 161019 \$9.95 |
| 3 DUAL CHOKE
12 HY at 200 MA. per section. 150 Ohms DC res. Steel case with stand-off insulators. No. 2785 \$4.95 | 10 RCA 1 KW MODULATION TRANSFORMER
Primary will match class "B" tubes up to 10000 ohms plate to plate. Secondary No. 1. 450 MA or beam tube plate. Secondary No. 2. 80 MA for screen grid \$14.95 |
| 4 FILTER CHOKE
4 1/2 HY. 150 MA. 70 ohms Res. DC Hermetically sealed in case. Stand-off insulators No. 5209 \$1.29 | 11 SCOPE TELEVISION TRANSFORMER
2100 volts at 10 MA. Pri. 115 VAC. 60 CY. Steel case with stand-off insulator. No. 87 \$4.25 |
| 5 TRANSMITTING FILTER CONDENSER
2 Mfd. 4000 VDC all filled regular net price \$25.44. Our give away bargain price \$4.50 | 12 PLATE TRANSFORMER
2010 VCT 200 MA. Pri. 105-125 VAC 60 CY. Steel case screw terminals. No. 8275 \$9.95 |
| 6 FILTER CHOKE
4 HY. 300 MA. 40 ohms DC resistance. Hermetically sealed in case. screw terminals. No. 6317 \$4.95 | 13 PLATE TRANSFORMER
1400/1200 VCT at 260 MA. Pri. 115 VAC 60 CY. Hermetically sealed steel case. screw terminals. No. 8031 \$7.95 |
| 7 HIGH VOLTAGE FILTER CHOKE
8 HY at 1.2 Amps. 27 ohms. DC resistance. 12500 volt breakdown insulation. Shielded case and stand-offs. No. 6813. A super buy at \$17.95 | |

HI POWER PHOTO FLASH KIT

Complete Kit including AMGLOW tube, carrying case, etc., with simple assembly and operating instructions. Price subject to change without notice. Write for detailed description and Parts list.

\$77.50

BRAND NEW ARMY SURPLUS KEY—Large coin silver contacts. Bargain at \$0.98

BIG TRADE-IN ALLOWANCE ON YOUR USED EQUIPMENT

And for Bigger-Than-Ever Trade-In Allowances on Your Used Equipment you'll find your Trade-In's worth more at the Walter Ashe Store! Select your new equipment from the list shown here. Tell us what you have to trade. We'll guarantee you a really important saving. Wire, write or phone today!

YOUR FAVORITE BRANDS OF TEST EQUIPMENT

- | | |
|----------------------|---------------|
| Hickok | Waterman |
| Jackson | Du Mont |
| Precision | Feller |
| Simpson | Melissner |
| McMurdo Silver | Triplet |
| Radio City Products | Reiner |
| Robson-Burgess | R.C.A. |
| Chicago Industrial | Bliley |
| Special Products Co. | Hantlan |
| Industrial Equipment | Superior |
| Cornell Dubilier | Monitor Piezo |
| Coastwise Electronic | Weston |
| Supreme | Sprague |

WJSD WJULM WJWDM WJQDF WJPCI
WJWNR WJQDF WJDIYD

watts, substitute a power transformer with a high-voltage secondary delivering 855 volts each side of center at 250 ma. The output transformer should be rated at 45 watts or more, with a plate-to-plate impedance of 10,000. Change R1 to 134 ohms, 8 watts; R2 to 2750 ohms, 40 watts; R3 to 2950 ohms, 40 watts; and R4 to 3 megohms.

Twelve-volt tubes (1625's and 12SJ7's) can be used in these circuits with proper changes in the filament supply.

600-MC OSCILLATOR

The steady climb toward higher communication frequencies requires that new design and construction techniques be applied to receiving and transmitting equipment. A simple oscillator operating up to about 600 mc is useful in investigating u.h.f. and v.h.f. characteristics and techniques.

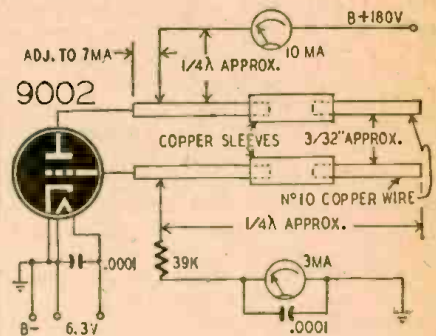

This 600-mc, long-lines oscillator circuit using a 9002-u.h.f. triode was shown in the RCA Guide for Transmitting tubes. The plate and grid lines consist of short pieces of No. 10 bare copper wire with tight-fitting copper sleeves for tuning adjustments. Each line is about 5 inches long for 600 mc. They are parallel and about 3/32 inch apart.

The grid leak is clipped to its line about 1/4 wave length from the open end. The grid current at this point should be about 1.5 ma. The plate tap is adjusted for 7 ma plate current. A hair-pin loop above and parallel to the lines makes a good output coupling device. Power output is about 0.5 watt.

THE QUESTION BOX

(Continued from page 48)

A. In this circuit, a pair of 150- or 200-ma selenium rectifiers is suggested to carry the current drawn by the amplifier. The input circuits have separate volume controls. A master control may be used in the grid circuit of the 6SJ7 by replacing the 500,000-ohm fixed resistor in this circuit with a 500,000 variable resistor with the arm connected to the grid.

With the filaments supplied through a dropping resistor, it is necessary to shunt the 6SJ7 and 6F5's with 42-ohm, 2-watt resistors. You may connect the filaments in parallel and supply the voltage from a 6.3-volt, 2-ampere filament transformer. The heavy line on the diagram indicates a common negative bus that is insulated from the chassis.

NEW RADIO-ELECTRONIC CIRCUITS

(Continued from page 41)

plies enough gain to drive the class-AB1 807's to full output with less than 0.25-volt input. The output transformer should be able to handle at least 30 watts and have a plate-to-plate impedance of 6,600 ohms. The halves of its primary should be closely coupled to prevent phase shift in the feedback loop between one side of the primary and the screen grid of the 6SJ7-GT. Perfectly balanced transformers are almost unobtainable, so a 50- μ f bypass is in the 6SJ7 plate circuit to prevent parasitics at high volume levels. The

amplification is down only 1.5 db at 10,000 cycles. If a greater reduction of highs is desired, increase the value of bypass. When output is viewed on a 'scope, parasitics will be indicated by widening of the trace for a portion of the cycle.

The output tubes are operated with semi-fixed bias, a part of the bias being developed by the bleeder current flowing through R1, and the remaining portion by the cathode current of the 807's.

For 30 watts output, use values in the diagram. To increase power to 45



MAGNETISM

(Continued from page 29)

The magnetic carrier

Although many factors are to be considered in the design and manufacture of magnetic tapes or wires for recording purposes, the most important are the *residual induction* and *coercive force* of the material. These 2 characteristics are best understood by examining the material's so-called *hysteresis loop* (which is nothing more than a visual indication of the lagging of magnetic induction—flux—behind the magnetizing force which produces the magnetism in the material). See Fig. 8.

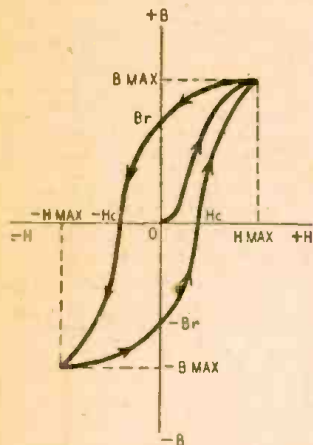

Fig. 8—Magnetic hysteresis, or B-H, curve.

The horizontal axis H represents the value of the magnetizing force per unit length applied—positive and negative. The vertical axis B represents the amount of flux per unit area induced in the material. Measurement begins with the material completely demagnetized (at O intersection of lines H and B). The magnetizing force is increased to a positive value beyond which further increases in magnetizing force produce no increase in the magnetism of the material. This registers a curve from O to B max on the chart. Then the magnetizing force is reduced to zero. However, a certain amount of induced magnetism *remains in the material*—as represented by the intersection of the return curve from B max to B at B_r . This B_r value

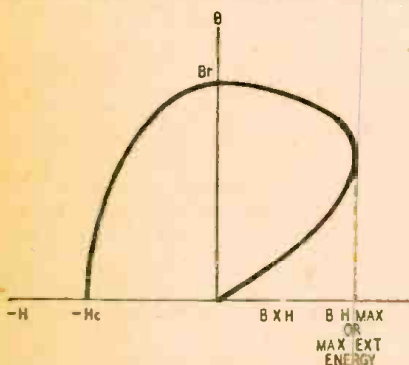

Fig. 9—The important demagnetization loop.

represents the peak residual magnetism the material will retain without demagnetizing influence. From this point, the

(Continued on page 80)

ARE YOUR SCR-274-N (or AN/ARC-5) RECEIVERS JUST A MESS OF WIRES AND PLUG TERMINALS TO YOU?

DO YOU WANT SCHEMATICS? INSTRUCTIONS? EXPLANATIONS?

Here's a 12-page folder, each page full letterhead size (8 1/2" x 11") with the answers to all your questions. Simplified schematic and explanation of the control and power circuits and all the plugs. Instructions for simple conversion of the blank adapter in front to a local-control adapter, with volume control, on-off switch, and CW-MCW switch. Schematic and parts list for A-C power pack. Complete alignment instructions for RF, IF, and BFO. Top and bottom views with 109 arrows showing parts locations.

Voltage and resistance readings to aid troubleshooting. Schematic of receiver with 3-unit rack, 3-unit control box, and adapters. Three large complete schematics, one each for BC-453-A or -B (same as R-33/ARC-5), BC-454-A or -B (same as R-21/ARC-5), and BC-455-A or -B (same as R-22/ARC-5), each schematic with coil and transformer sub-schematics, parts list, etc. This folder is invaluable, but costs you only two dollars postpaid. Include with your order.

A COMPLETE AND DIFFERENT SET FOR THE BC-946-B (R-24/ARC-5) BROADCAST-BAND RECEIVER

This set of sheets is also 12 pages, with practical wiring diagram; control-circuit explanation; A-C power pack; top and bottom views with parts-location arrows; schematic, parts list, and complete detailed step-by-step instructions which any beginner can follow to convert the set for a speaker (BFO replaced by audio driver stage); changing the R-F volume control to A-F control and adding delayed

AVC; front-end adapter changeover; alignment; etc. Also two dollars postpaid.

SPECIFY WHICH SET OF SHEETS YOU WANT. Print your name and complete address in the upper left corner of the envelope.

R. GOODHEART
2616 N. Spaulding Ave. Chicago 47, Ill.



OLSON RADIO WAREHOUSE, INC. AKRON, OHIO

A Radio Man's Best Pal!



3¢ that's all
A Postage Stamp Is O.K.

LIMIT—
ONE TO EACH RADIO MAN

You can read all resistor code-colors in a flash with this handy pocket guide! Revolving wheels in color show all resistance values. OLSON gives you this valuable tool (size 4 1/4" x 2 1/4") for a piffling 3c. GET ONE NOW.

This offer good only in U. S. A.

RADIO REPAIRMEN'S PRICE GUIDE

—and you get this big new **CATALOG FREE!**
60 rip-snorthin' pages of special OLSON Bargains in Standard Radio Parts, Sound and Testing Equipment.

Clip the coupon and MAIL TODAY

OLSON RADIO WAREHOUSE INC.

73 E. MILL ST., DEPT. 99, AKRON, OHIO

I enclose 3c. Send me 1 "Resist-O-Guide" & new Free Catalog of Olson Bargains.

I am a Repair Man. I am an Amateur or Experimenter.

NAME _____

ADDRESS _____

CITY _____ STATE _____

FOR HIGH FIDELITY AT LOW COST! -the UNIVERSITY TWEETER

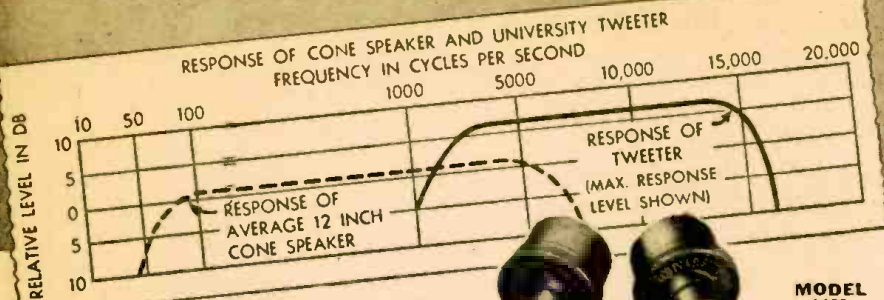

MODEL 4402

- MODEL 4404**
Dual Tweeter in Walnut Cabinet with High Pass Filter and Volume Control.
List Price \$60.00
- MODEL 4402**
Dual Tweeter only
List Price \$40.00
- MODEL 4405**
High Pass Filter and Volume Control.
List Price \$10.00

The reproduction of music and voice with breathtaking realism is now possible with the new UNIVERSITY Dual Tweeter. Used in conjunction with any standard 12" cone speaker in FM and AM radio equipment and wide range phonograph amplifiers, it adds the brilliant "highs" so frequently carried through all stages of amplification, only to be lost in the bottleneck of a single unit reproducer. Frequency response is 2,000 to 15,000 cycles. The die-cast dual horn design permits 100° horizontal distribution and 50° vertical distribution. A high pass filter with auxiliary high frequency volume control, permits easy connection by merely attaching two wires to the existing speaker. Mounting space only 2 3/4" high x 9 1/4" wide. Power handling capacity 16 watts, impedance 16 ohms. For complete information write today to UNIVERSITY LOUDSPEAKERS, INC., 80 South Kenosia Avenue, White Plains, New York.

University Loudspeakers

NEW LOW PRICES

- SPEAKERS**
- 5" P.M. Alnico 5 Magnet, \$1.09 each
6 for \$6.00
- 6" P.M. 2.15 oz. Alnico 5 Magnet, \$1.69 each
6 for \$9.00
- All other sizes in stock, at money-saving prices.

- Volume Controls**
- 1/2 MEG. volume control with switch and long shaft, ea. 49c
6 for \$2.75

- Money KITS Saving**
- 100 Insulated Resistors, 1/2, 1 & 2 Watt, \$1.95
- 20 Assorted Wire Wound resistors... 1.95
- 50 Popular Assorted Mica Condensers... 2.50
- 20 Assorted Tube Sockets... 1.00
- 20 Assorted Trimmers 1.00
- 15 ASSORTED VOLUME AND TONE CONTROLS (less switches) \$1.95
- I.F.'s 455 KC... 39c

CONDENSERS
Tubular Paper (600 V. Test)

Mfd.	VDC	Price Ea.	Per 100
.01	.08		\$ 6.50
.02	.08		6.50
.05	.10		8.00
.1	.12		9.00
.25	.17		13.50
.001	.08		6.50
.002	.08		6.50
.005	.08		6.50
.006	.08		6.50
.5	.26		22.50

"Illinois" Electrolytics

Mfd.	VDC	Price Each
10	25v	.30
100	25v	.48
12	50v	.34
16	150v	.36
20	150v	.38
24	150v	.38
30	150v	.40
50	150v	.48
8	450v	.38
10	450v	.42
16	450v	.54
20	450v	.60
40	450v	.80
100	15v	.45

"Illinois" Duals

Mfd.	VDC	Price Each
16-16	150v	.50
20-20	150v	.52
30-30	150v	.60
40-20	150v	.60
50-30	150v	.68
8-8	450v	.68
10-10	450v	.74
20-20-20	150v	.84

100% discount on all electrolytics if purchased in lots of 10 or more. Mica Condensers, all sizes, 8c each.

- AUTO RADIO SUPPLIES**
- OZ4 TUBES, each... 89c
Minimum order, 6
- SPARK Plug SUPPRESSORS, 11
See our Catalog for full line of auto aeriels.

- PHONO SUPPLIES**
- Crystal Pickup Arms... 2.49
- Webster No. 50 Changer... 21.17
- Webster No. 56 Changer... 26.66
- Webster No. 70 Changer... 43.20
- Free \$2.50 permanent needle with each changer.

HEAVY DUTY POWER TRANSFORMER

Thordarson T70R62, 115V. 60 Cycle primary. Secondary 700 V.C.T. @ 145ma., 6.3V. winding @ 4.5 amps; 5V. winding @ 3 amps. Special price while limited quantity lasts \$3.95

Minimum Order \$3.00—20% with Order. Balance C.O.D.—WRITE FOR CATALOG.

TWO CONVENIENT PLACES FROM WHICH TO ORDER. PLEASE ADDRESS DEPT. C10.

ELECTRONIC DISTRIBUTORS, INC.
620 W. Randolph St., Chicago 6, Ill

12lbs. SURPLUS ELEC-TRONIC PARTS \$2.00

A gold mine of parts for repairmen, amateurs, and experimenters... sockets, condensers, resistors, transformers, coils, hardware, wire, etc., etc. An outstanding bargain in usable parts! Send \$2.00 cash, check or M.O. today! (Pay small express charges on receipt.)

ELECTRONIC PARTS CORP.
436 W. State St., Milwaukee 8, Wisc.

MAGNETISM (Continued from page 79)

magnetizing force is changed in direction and increased to a negative saturation. This describes a curve from B_r to an intersection with the H line at $-H_c$ and on to a negative B max. Again the magnetizing force is reduced to zero, producing the curve from negative B max to negative B_r . Re-establishment of positive magnetizing force carries the curve from negative B_r to positive B max. Repetition of this magnetization and demagnetization process will result in the establishment of the complete symmetric loop about point O—the hysteresis loop.

Demagnetization curve

Most of the information required about a material is gained in the segment of the hysteresis loop (B_r to H_c) known as the demagnetization curve (Fig. 9). As explained, the value marked on the B line at point B_r indicates the maximum residual induction. The value marked on the negative side of the H line at H_c indicates the demagnetization force per unit length required to reduce the residual magnetism to zero. This is known as the *coercive force* of the material. Furthermore, it can be shown that the product of the flux density B and the unit demagnetizing force H represents the amount of magnetic energy that each cubic centimeter of the material is capable of supplying. In actual units, $B \times H$ divided

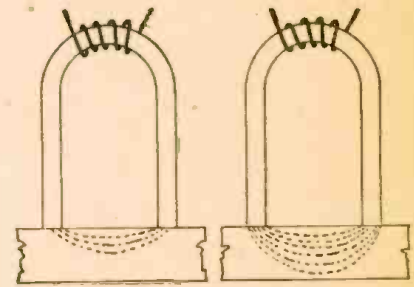

Figs. 10-a and 10-b—Patterns with large gap.

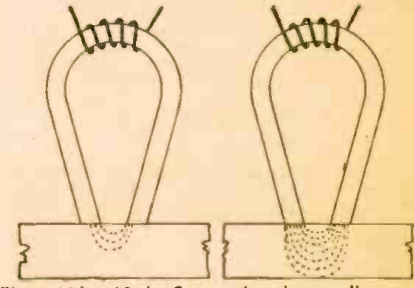

Figs. 10-c, 10-d—Same signals, smaller gap.

by 8π equals ergs per cubic centimeter. In normal practice, however, only the product of $B \times H$ is quoted.

The variation of $B \times H$ between B_r and H_c is shown on the right side of the demagnetization curve. From a practical standpoint, it can be shown that a magnetic wire or tape designed to operate at a point on the demagnetization curve corresponding to the maximum value of $B \times H$ will supply the

maximum amount of flux per unit volume of the material.

Other important characteristics of magnetic signal carriers include factors which influence transference, penetration, and self-demagnetization.

Transference, as previously indicated, is the property of transferring magnetic induction from one magnet to another by contact or near-contact. The degree of transference depends upon the magnetomotive force exerted by the modulator, the depth of magnetic penetration, and subsequent self-demagnetization. Both of the latter functions are dependent upon the thickness of the carrier, the air gap in the modulator, and the recorded wave length.

If we could stop the magnetic modulating process instantaneously and examine the magnetic fields produced within the carrier during the peak energy transfer period of a weak and strong signal fed into 2 modulators, one with a relatively large gap and the other with a smaller one, the magnetic field within the carrier probably would resemble Fig. 10.

Fig. 10-a shows the small degree of penetration obtained with a large gap and low signal (magnetomotive energy). Fig. 10-b indicates the deeper penetration obtained with a larger signal. A further increase of signal energy would saturate the carrier. Fig. 10-c shows the shorter effective magnetic field generated in the carrier by the small gap. As the gaps become smaller and smaller the induced magnetic fields become shorter and shorter until the magnetic isolation between pole pieces decreases to a point where a magnetic short takes place so that no energy is subsequently available for excitation of the magnetic detector. This is a form of self-demagnetization. This is roughly equivalent to decreasing the insulation between plates of a condenser until the leakage becomes so high that virtually no charge remains in the condenser. Self-discharge in an electrical sense is approximately analogous to self-demagnetization in a magnetic sense).

Other factors which influence the design and application of magnetic modulators (recording heads), magnetic detectors (playback heads), magnetic demodulators (obliterating heads), and their interrelation with the magnetic carrier (wire or ribbon) will be discussed in a succeeding article *Elements of Magnetic Recording* scheduled to appear in the November issue of RADIO-CRAFT. Comments from readers will be welcomed by the author. Address all correspondence care of RADIO-CRAFT.

NUMBERS 4 and 5 OF THE WALSCO Hit Parade

THE SENSATIONAL, NEW, SCIENTIFIC

WALSCO STANDARD TEST RECORD

FOR IMMEDIATE . . . ACCURATE . . . AUDIBLE ADJUSTMENT OF RECORD CHANGERS AND COIN OPERATED PHONOGRAPHS . . . SOLVES THE PROBLEM OF ADJUSTING PICKUP AND TRIPPING MECHANISM THROUGH

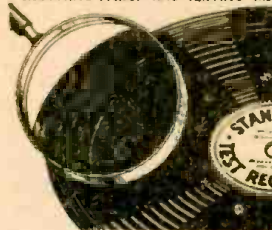

- SOUND!**
- Three Tone lead-in grooves permits immediate adjustment to proper set down position of the pick-up through audible means.
 - Made to RMA and NAB standards.
 - Record plays in less than 40 seconds.
 - Audio tone at end of record indicates proper adjustment of tripping action.

The WALSCO Standard Test Record saves time and increases efficiency in the adjustment of record changers and coin operated phonographs. Write for full information.

WALSCO products
Help The Radio Man

WALTER L. SCHOTT CO. BEVERLY HILLS CALIF. CHICAGO 5, ILL.

WALSCO UNIBELT
THE UNIVERSAL DIAL DRIVE BELT CAN BE CUT TO FIT ANY DIAL DRIVE
Will not Slip or Stretch

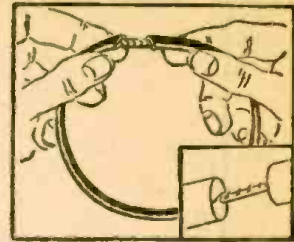

"UNIBELT" comes in 5-foot length spools and can be installed without taking dial mechanism apart. A real time and money saver. Eliminates the need for stocking numerous sizes of belts.

Free sample and literature. Write to Dept. 10B

RED HOT SPECIALS

Limited quantity for immediate shipment—
while they last

8,000 OHM DUAL HEADSET H-16/U

Priced at **\$1.89**

Include 25c to Cover Cost of Postage



Light, durable, and efficient phones featuring a permanent magnet with an 8000 ohm transformer built into each unit. Molded soft neoprene earcup shaped to snugly and comfortably envelop the entire ear. Steel headband with new type adjustable sliding brackets allow earcups to be extended or retracted. Cover plates constructed of lightweight magnesium. No removable parts to become loose or lost. Especially suited to hams and commercial operators, recording engineers, aircraft pilots and similar exacting applications. Hi-impedance, extremely sensitive. May be used as sound powered interphones without use of a battery. Can even be used with simple axtal to make a complete radio receiver.

Carbon Throat Microphone

This microphone will work into any 200 ohm impedance input circuit. Has adjustable strap to fit any neck. In operation this microphone is strapped around the throat thereby facilitating full freedom of both hands and head movement. Ideal for ultra high frequency mobile work for hams. Can also be used as a hi-grade Carbon Mike by simply drilling three holes in case. Sensitivity of this mike equal to mikes costing \$10 and \$15. Supplied with strap, 10' cord and plug. Your Cost



49c

Combination Offer

Both Items **\$2.25**
Include 25c to Cover Cost of Postage

20% deposit on all orders unless rated.

NIAGARA RADIO SUPPLY CORP.

160 GREENWICH ST., NEW YORK 6, N. Y.

All prices F.O.B. N. Y. C. Write for latest Bulletin 10RC

BARGAIN SPECIALS

	YOUR COST
LEE RADIO, A.C.-D.C. 4-Tube Compact Model, HOT retailer at \$12.95	\$9.75
ELECTRIC PORTABLE PHONOGRAPH, Original list \$29.95	14.90
SUPERIOR SIGNAL TRACER No. CA-12, latest model, all purpose	34.85
RADIO MECHANICS REPAIR STAND, holds chassis while repairing	8.95
BROOKS INVERTER, 50 Watts, 110 V.	8.95
35Z5, 50L6, 12SA7, 12SK7, 12SQ7, Complete Tube Kit	2.31
35W4, 50B5, 12BA6, 12BE6, 12AT6, Complete Tube Kit	2.31
RADIO CHASSIS KIT, build your own 5-tube Radio, less wire and cabinet	10.95
PHONOGRAPH MOTOR, standard brand with 9" Turntable	2.95
PICK-UP ARM, crystal type complete with hardware	1.75
TELEVISION ANTENNA, List \$14.50	7.25
100 ft., 300 ohm LEAD-IN WIRE	2.25
100 ft., COAXIAL CABLE, RC59U, 72 ohm.	6.90
ELECTRIC HEATER, Floor Model, U.L. Approved, sells for \$24.40	8.95
ELECTRIC BROILER, original price \$19.17	8.45
ELECTRIC IRON, automatic, lists \$9.95	5.25

Note—All items are TOP QUALITY, sold with a money back guarantee. We invite sample orders. Don't Delay as some items are subject to prior sale.

WIRE — WRITE — PHONE

BROOKS RADIO DISTRIBUTING CORP.

86 VESEY STREET (Dept. A), NEW YORK 7, N. Y. (COrtlandt 7-2312)

MIND POWER

A FREE BOOK

Develop your personal, creative power! Awaken the silent, sleeping forces in your own consciousness. Become Master of your own life. Push aside all obstacles with a new energy you have overlooked. The Rosicrucians know how, and will help you apply the greatest of all powers in man's control. Create health and abundance for yourself. Write for Free book, "The Mastery of Life." It tells how you may receive these teachings for study and use. It means the dawn of a new day for you. . . Address: Scribner D. Y. W.

The **ROSICRUCIANS**
SAN JOSE (AMORC) CALIFORNIA



HOTEL STRAND

Atlantic City's Hotel of Distinction

The Ideal Hotel for Rest and Relaxation • Beautiful Rooms • Salt Water Baths • Glass enclosed Sun Porches • Open Sun Decks atop • Delightful Cuisine • Garage on premises • Open All Year.

Write for Literature

Exclusive Pennsylvania Ave. and Boardwalk

RADIO GADGETS

(Continued from page 17)

utilizing the natural vibrations of an operating radio set can be evolved with a little ingenuity. Specialty stores, department stores, radio stores and other outlets are always ready to buy such gadgets; every parent of young children is a potential buyer.

Radio sets, as we all know, give out a considerable amount of heat. To the best of our knowledge, such heat effects have not been used for any radio gadget.

Last spring at the Chicago Radio Show we gave away a booklet wherein the trade was treated to a collection of humorous radio ideas. Purely fanciful, they still contained the germs of ideas for successful gadgets. We mention only two of these which made effective use of the heat in radio sets. The first one was called the "Humidoradio." The idea here is to have a small flat tank placed just above the radio tubes. The little tank contains water, while a small pipe leads into the top cigar compartment. As the water evaporates, the cigars are humidified.

Another idea, the "Warmeradio," also a humorous one, was to seal the radio hermetically so no heat could escape. Two holes were fashioned in the top of the receiver. You placed your baby's milk bottles into the openings to keep them hot!

It would seem that some clever designer could make better use of the surplus heat generated by the radio tubes for other and more practical purposes. We can think of moving figures for toy purposes, revolving colored discs or globes to amuse Junior, and dozens of other similar ideas. Low-price gadgets of this type, if well made and reliable in performance, are always in demand.

To the best of our knowledge, neon tubes have so far not been harnessed to radio sets for visual effects. These colorful tubes use very little current and produce exceedingly beautiful effects. We can make small glass figurines, which glow softly in green, red, and other colors in the dark. It is a simple matter to connect such a device in the audio circuit of your radio so that the figures or illuminated devices would glow in unison with the music. If produced in quantities, such an item can be made reasonably cheap; it will find a ready sale not only for home use but in stores which sell radio sets, etc.

We now come to another branch of radio gadgets. These are in the servicing field. In this magazine we describe from time to time a number of such ideas, particularly pocket radio servicing probes. There is always a good market for these, especially those that can be sold at low prices. Servicemen require them and will buy if the item is priced right and works well.

At the present time there is an abundance of war surplus material, much of which can be bought at low cost and which can be used by the manufacturer of servicing gadgets of this

it's NEWARK for BETTER SERVICE - BIGGER VALUES!



You can use this!
BEACON RECEIVER
BC-1206-B

Truly sensational buy for Hams, Experimenters! 5-Tube Set, tunes 195 to 420 Kc. (A-N beam signals. Operates on 28V DC; easily changed to 110V. 4"x4"x6 1/2" long. Wt. 3/4 lbs. Complete with tubes, slightly used, A-1 condition, and it's all yours for only **\$3.95**

Amazing New
PILOTUNER
adds F-M to
ANY Receiver!



Simple to connect, it brings you all the benefits of FM reception formerly available only in expensive models... now at an astonishingly low price that everybody can afford! Features: 5 tubes plus selenium rectifier; 3-gang cond., Built-in FM Antenna; self-contained AC pwr supply; handsome walnut wood cabinet 8 3/4" x 6 3/4" x 5 3/4". YOU can own it, for only **\$29.95**

MILLEN "R9er"

Bring those 6 and 10 meter signals out of the noise with this new Antenna Matching Pre-amplifier. At least 30 db. gain in both bands! Uses 6AK5 tube. Complete with coil unit for 10-11 meters. less tube... **\$24.75**
6 or 20 meter coils, each... **\$3.15**
6AK5 Tube... **90¢**
MILLEN 90800 50-Watt Transmitter-Exciter... **\$42.50**



Only A Few Left!

SCR-522 TRANSCEIVER

One of our most sensational values! These wonderful surplus 2-meter rigs for practically a song! Receiver and transmitter less power supply and control box. Some have crystals, some may be missing. But the basic unit is there — ready to operate. Can be converted to 110V AC. Schematic included. Shpg. wt. 75 lbs. Limited quantity at this amazing price. **\$14.95**
The whole works, as is, for only...



Available F.O.B. New York only

Look at this TERRIFIC BUY!

MARK II

40 & 80 Meter Complete
XMTR-RCVR



You've got to SEE it to BELIEVE it! Complete mobile rig, suitable for truck, boat, auto. Dynamotor power supply included, works on 12 or 24 volt battery. Easy to rewire set for 110V 60 cycle AC. Schematic included. And it's all yours, Transmitter, Receiver, Dynamotor Power Supply, complete with tubes, less ext'l accessories, shpg. wt. 130 lbs. **\$29.50**

YOUR COPY of our GIANT
BARGAIN BULLETIN #4-C
is ready now...
SEND FOR IT TODAY!

Complete Line of
RCA TELEVISION
components in stock.
All makes of
Television Kits,
ELECTROTECH,
TRANSVISION, etc.

HANDSET TS-13

We've SMASHED the price on this fine handset! 200 ohm carbon mike, 2500 ohm earphone, butterfly switch, PL68, PL55 plugs, 6 ft. rubber cord. BRAND NEW and it's yours for only **\$2.39**



THORDARSON 'SCOPE TRANSFORMER

Gen'l purp. Pri: 110V 60cy. Sec. 750VCT @ 160Ma, 1450V @ 2Ma, 6.3V @ 1 amp. SMASHING LOW PRICE!
No. 5-542... **\$3.49**

THORD. ALL-PURP. FILAMENT TRANS.

Pri: 105 to 250V 60 cy. Sec: 6 1/2V @ 20 amps, 6.3V @ 3 amps, 5V @ 3 amps. NOW YOURS FOR ONLY **\$3.49**
No. 5541



ORDER FROM
New York or Chicago
Shipments FOB N.Y. or Chicago
20% Deposit Required
with C.O.D. Orders
Send Full Amount of
Order—Save C.O.D. Chgs.
Prices Subj. to Change

BUY OVER \$75 WORTH OF EQUIPMENT Take ONE YEAR to PAY
20% Down—Pay Monthly

NEW YORK
Offices & Warehouse
242 W. 55th St., N.Y. 19

NEWARK
ELECTRIC COMPANY, INC.

CHICAGO
323 W. Madison St.
Chicago 6 Ill.

New York City Stores: 115-17 W. 45th St. & 212 Fulton St.

A Chinese Radio Exhibition will be held in Nanking in May, 1948, the Chinese Amateur Radio League announces. Amateur organizations all over

the world are invited to contribute or loan station photographs and any other items which might be of interest in such an exhibition.

type. Any new device that will make it easier for the radio serviceman to service his sets — provided such an item is low enough in cost—will find an excellent market.

Fortunes are still to be made in radio gadgets of the types we have discussed here. This country with its superabundance of radio sets should be an inspiration to all inventors and designers. The potential market for such devices is incredibly large.

A CATHODE FOLLOWER

(Continued from page 37)

a Hammond 434.

In the circuit, the resistor *R* is chosen to give the -22 volts bias required for the 6F6 tubes, measured from cathode to driver-transformer secondary center tap.

The driver stage has two 6C5 tubes in push-pull and is also a phase inverter with direct cathode coupling.

The single-tube 6C5 stage has a frequency-compensating circuit consisting of *C* and *CH*. The tone control gives separate bass and treble boost. The values of *C* and *CH* should be arrived at by experiment in order to give best results with other parts used. I used .01 µf. for *C* and 30 henrys for *CH*. The choke should be mounted where the least hum is induced in it from the power transformer and filter choke, as it is especially susceptible to such hum pickup.

The remaining 6C5 and 6SJ7 stages are standard and give ample gain for phono and microphone.—Robert M. Crooker.

Radio Thirty-Five Years Ago

In Gernsback Publications

HUGO GERNSBACK

Founder

Modern Electrics	1908
Electrical Experimenter	1913
Radio News	1919
Science & Invention	1920
Radio-Craft	1929
Short-Wave Craft	1930
Wireless Association of America	1908

Some of the larger libraries in the country still have copies of ELECTRICAL EXPERIMENTER to file for interested readers.

From October, 1913, ELECTRICAL EXPERIMENTER:

How to Build a Magnetic Hysteresis Detector, by H. Winfield Secor.

Sound-Operated Electric Dancer
"Electro" Audion Detector Used at University of Michigan Radio Laboratory.

Wireless Without Usual Ground Connection.

The Radio Detectometer
The Poulsen Motor Tikker
A Novel Oscillation Transformer
Music by Wireless Now
Hudson Valley Wireless Association
New Chicago Wireless Station
Wireless Telegraphy at State Fair
Amateur Installs Wireless Phone.

"TAB" Electronic Parts

New Guaranteed THAT'S A BUY

866A's Combination Transformer & Sockets



CONSISTS OF TWO JAN NEW 866A TUBES, TRANSFORMER GARDNER ELEC CASED 2.5V 10 AMP, 115V/60c/vnt, H.V. insld 9000V wkg similar to illustrated unit. "TAB" Tested 16000 VAC Test! Same mtr as KENYON T89-SOCKETS CERAMIC JOHNSON 214. "TAB" SPECIAL \$5.95
 TRANSFORMER ONLY for Two 866A's... \$3.95
 EDISON TIME delay Relay 115V/10amp. ca. 12.00
 872A TRANSFORMER, 115 60cy... 6.95
 RM-33 Telephone Remote control... 2.95
 BC605D Interphone Amplifier... 7.95
 MICROSCHWITZ, 2 for 39c TEN for... 1.49
 MICRO "MUSWITCH" SPDT 15A/125V, 2 for... 1.08
 MICROSCHWITZ Plunger safety SW, 2 for... 1.00
 EDISON TIME delay Relay 115V/10amp. ca. 1.49
 HEADPHONE H830/98c ea. 2 sets... 1.65
 Dynamic MIKE or SPEAKER... .98
 MIKE WE, push to talk & plug... .98
 Dynamic Mike WE, D141924... 2.49
 Choke 15H/400ma/125ohms or 20H/300ma/15KV cased... 7.95



PRECISION RESISTORS SHALLCROSS MEPCO, INST. RES. CO. OHMITE, WE, and others for METERS, BRIDGES, AMPS & LAB EQUIP.

ACCURACIES *1/2, **5%, 10% (Best 1%)

1	25	50	75	80
100	100	150	300	350
400	500	1250	1500	2000
2142*	4000	4300	4900	5000
7950*	8000	9710	10000	12000
15000*	7000	20000*	30000*	50000
80000	84000	90000	147000	168750

Above sizes asstd.TEN for \$2.50
 20000 4000 100000 130000 140000
 150000 165000 201000 229000 250000
 Above sizes asstd.30c ea.TEN for \$3.00
 330000 402000 500000 800000 950000
 Above sizes asstd.90c ea.TEN for \$5.00
 ONE Megohm WW1% acy each 90c @THREE for \$2.00
 2meg. 4.5meg 5meg. 10 meg.SIX for \$3.00

WRITE FOR OTHER SIZES FROM STOCK

Sprague Megomax 10 or 12megohm/10KV ca. \$1.49
 WESTON 1/2 of 1% precision 2.5 meg.4.95
 IRV Navy precision 1 meg 1/2 of 1% MF1.69
 IRC Navy Precision 2meg. 1/2%4.95
 WESTGHE "DB" Bk1 esd MTR 3 1/2" SQ minus 10plus8DB 3 1/2" SQ Bk1 esd.4.95
 WESTGHE one 2meg. 1%4.50
 McCintock 3 1/2" BC 0.1ma mtr esd.3.95
 De Jur 2 1/2" B'C 0.1ma mtr std scale2.95
 GE RF mtr 2 1/2" B'C either loraamp.3.95
 WESTON 476A 15voltair 2 1/2" sqbilled4.95
 WESTON 506 mtr-10plus8DB 2 1/2" B8Case4.50
 GE DW54 mtr-10plus8DB 2 1/2" D Case3.95
 GE Galvo 3 1/2" B'CD 2.5425 ma. 0 center.3.95
 GE DW41 mtr 2000V/1000 ohms & res.5.95
 SONAR QBF echoranging equipment.1000.00
 SC-1 RADAR GE NEW TEN CASES2000.00

TRANSF Hm'telly cased pri 50-800cy/80-115V sec 100VCT & 300V/110ma; 6.3V/3A! Three 0.3V/1.5A, 0.9V/1.25A & 2H cased chokes 10H/110ma & Two oil condens 3md/330VAC/1000WVDCpyranol & RK80/1641 tube... 59.95
 Transf. 9800V/15ma. Pri 115V/804.400cy 35ma... 9.95
 Tr 1500V/35ma, V'Dblr, Pri 115V/80 cy... 15.95
 Transf. 2500V/15ma. Pri 115V/60cy esd... 5.95
 Transf. plate to line 98c; Line to V.C.98
 Transf. multi-tap line to line/1DB.1.95
 WE Dynamic microphone & 20ft cord.7.95
 Switch A1K11 60amp/600V, 250Amp/125V.1.00
 Switch door interlock GE7460390-64 (\$2.50)1.69
 METAL BOX NAVY 5 1/2"X10 3/4" X 7 1/2" hdies.1.45
 AUDIO BAND pass filter 60-90c/150 cycles cased & shld, each \$1.95. THREE for... 4.50

GR VARIAC 200V/Variol 0.134V00c/1A. \$9.95
 Transf 115V/60c pri; 120VCT/300ma 5.98
 Transf. 115V/60c pri; 700VCT/120ma/6.3V/2.4A, 5V/2amp. Special \$2.69 @ CASED TAP for... 5.00
 Transf. 115V/60 pri; 500VCT/80ma, 6.3V/4A cased n'tully sealed... 1.49
 TR 115V/200pri, 135VCT/150ma/0.3V/5A/5V/2A esd UTC7.50
 TR 115V/60c pri, 110VCT/212ma collins TR 115V/60c pri, 640VCT/1540V/250ma, cased... 6.50
 BLOWER 100CFM & Transf. 115V/60cy's BLOWER 125CFM/115V/60c enclosed... 8.95
 Voltage Regulator 05-130V/60cy/35Amps 10.95
 Voltage Reg. 0R-242V/50-60cy/500V 39.95
 Choke 20H/100ma/08c @ 50H/150ma 1.49
 Choke Swinging 15-20H/8/150ma... 2.95
 Choke 21H/300ma esd HVins... 2.95

GE A022 mtr 50 VAC & LAB STD 3 1/2" B'C. \$3.00
 GE A022 mtr 0-150VAC 3 1/2" B'C. 4.95
 Meter 0-150VAC, two inch case GE & Westhac 3.30
 Voltmeter 0-200VDC 100ohmsperV 3 1/2" esd. 4.25
 Voltmeter 0-250VAC 100ohmsperV 2 1/2" esd. 4.30
 WESTON 0-2500ma, 2 1/2" B' esd. 5.25
 WESTON AN 0-100k/100-0-100microamp/mtr. 3.95
 WESTGHE less Gadj, 0-100 & 100-0-micromtr 1.95
 Ge Inst Voltage Control relay RV/115V/60cy 2contact self reset, Callb 70/85/110/160V 5.95
 GE Thermostat adj 250V/25amp; 70to170°F 3.95
 CH luminous tip switch SFT. FOUR for... 1.00
 Telephone Switchboard B528.95
 Telephone WE Cell Mike9.95
 SUPER PHONO S.C. L.N. & cabinet85.00
 Tube Tester Supreme 5069.80
 Tube Tester & VOM Radio City 803LN*59.50
 RA34 Power Supply LN* AC/BC19149.95



DYNAMOTOR NEW HIEFF P MAGNET ALNICO 12/24V Inpt TAB TESTED GTD 6V Inpt/1AMP, output 240V/100ma or 125ma Int duty Rated 500V/50ma at 12 or 24 V Inpt \$3.49

Dynamotor 12 or 24v inpt, 275v/110ma \$1.95
 INPT FILTERS49
 Dynamotor Inpt28V/104amp, outpt250V/60ma, cont duty, wgt 2 lbs; operates on 12v fields in battery; also 110VDCmotor (ARC)51.85
 Dynamotor DM-4, inpt120m24V, output225V/110 ma & 440V/200ma, cont duty. Rugged design Gov's Cost \$79. Special... 6.75
 Dynamotor DA3A, inpt28VDC, Outpt300VDC/280ma 150V/10ma; 14.5V/5amp cont duty, for Radio set SCR535 Special... 3.85
 Dynamotor PE-9 or HENDIXM-1A, DC inpt 24-28V, Outpt3000V/200ma, 150V/10ma 14.6V/5A, inpt & outpt leads, Voltage regulator & starting relays cased special.9.95
 SUPREME 542MTR 5000ohmsperV/24 ranges volts AC&DC to 1500; ohms 2 meg, DB/50 used LN15.95
 Test mtr like WESTON 0-100VOM res. 2.0V/5/15/150/750ohms&DC/1000ohms per V, 7.5 & 75made, ohms5000&50000. New in Oak case mfg'd to ordinance dept spec'd with test leads18.95
 Leather case Velvet lined for 697VOM... 2.95
 TESTER & CASE as above20.95
 SUPREME537 like WESTON564 reads .3-30/300/600VDC, ohms 1000/10000/100m/1meg LN13.95
 TRIUMPH324 Tester 0-150/300VAC ohms 5000/5meg; 0/60/120/300/800ma DC LN10.95
 WRITE "TAB" for test equipment

STORAGE Battery Willard 2volt \$1.98 @ plastic nonspl TWO for \$3.88
 IF STIPE Dome's 236AKS 1" BALL 9.49
 HANDIE TALKIE BC811 Chassis, coils & X Revr BC455A & tubes ARCS \$4.50, with Dyn GAS GENERATOR SET Pu-6/TFS-1 output 27VDC/400watts&15VAC/1400watts100.00
 BC1073 SIGGENERATOR & VHFvavemeter.24.95
 SCR522 RCVR & XMTR 100-150mc's18.00
 Navy sound projector used.9.95
 CRYSTAL DIODE TEST SET 26RU NEW 16.95
 METER Rectifier Dual bridge BRADLEYLABS98
 CRYSTAL DIODE IN21 @ 45c. THREE for1.00
 CRYSTAL DIODE IN28 @ 81c. TWO for2.50
 CRYSTAL DIODE IN34 @ \$1.39. TWO for2.40
 Tuning Slugs with screw, asstd. 50 for1.00
 VIBRATOR 40V Eyrk 11.40; 60V 3V 98
 TG10/20watt6L6 amplifier & cabinet19.95

Autosyn New 115V/60cTYP5 PR \$18.00
 Synchro Differentials 115V/60cy. 6.95
 Autosyns type 5/50V, 2 FOR 115V/60cy FIL.8.95
 Synchro Differentials 5/50V3.50
 Autosyns Bronze type H/115V/60cy.18.00
 Autosyns AY1&5/24-28V/80&400cy.3.95
 Navy HRO complete coils, pwr supply Speaker, Rack 190 to 30mc's285.00
 Telephone Inverter, converter ringing machine KS-5492-0111, inpt 43-47VDC outpt 75-90V/20cy.25.00
 Rinjer telephone Holtzer Cabot 6V/20cy/6ma1.49
 TELERING. RD-90-TELKOR MODEL H inpt 110V/60cy, output 90V/20cy9.95
 WE TELEPHONE JACKS 223, four for1.00
 WRITE "TAB" TELEPHONE parts and equipment

KIT RESISTORS BT 1/2" x 1W 50 to 2 megs. \$2.50
 KIT CONTROLS 50-2megs pots ARJ. 10 for2.00
 KIT SILVER & MICA CONDENSERS, 50 for1.00
 KIT LUGS RADIO TYPE ASS'D 100 for1.00
 KIT FUSES ASS'D LITTLE FUSE, 300 for1.00
 KIT GROMMETS RUBBER RDO TYP. 100 for1.00
 KIT SOCKETS OCTAL/OCTAL, etc., 50 for2.95
 KIT CHECK FILTER RFC, RESA CONDENS.25
 CINCH miniature dual xtal sockets, 8 for1.00
 CRYSTAL socket 242 holder 3pins, 3 for1.00
 Socket for axial holders 4 1/2" & 3 1/2"1.25
 Speakers PM8.95
 Universal tube & Voice Coil transformer98
 7BPT/1813BPT Cathode Ray tube.8.95
 Remote Control telephone Amplifier14.95
 TS28 Telephone Test Set18.95
 National RBL-2/15 to 635kc rcvr45.00



COLLINS ART/13 SPEECH AMPLIFIER COMPLETE INPT

DYNAMIC OR CARBON MICROPHONE OR LINE INPT: Output 75-90V/20cy. Noise Level down -55DB. INCLUDES INPT TRANSFORMER. 1st AUDIO 10 Grids. MODULATOR TUBES, 6V6 sidetone adj. Jack, WT 5LBS, DIM 7 1/2" x 11 1/2" x 7 1/2" \$4.95
 minus tubes & pwr supply7.49
 WITH TWO 6V6 & 6SJ7 multi-cellular, nine Driver trumpet complete \$125.00
 REFLEX REFRANT TRUMPET projector 25 55DB. Includes W.E. in complete water. 29.95
 W.E. Driver PM heads, 25 to 55 watt, 14.95
 proof blastproof conservative rating \$12.95
 W.E. Diaphragm ES071349-3 for 21.95
 TWO for 3.95

TS&M S.C. TECH-MANUALS C "TAB" "TAB" OPEN THURSDAY TILL TEN PM

WRITE FOR MONTHLY "TABOGRAM" C "TAB" B-U Buy-We Serve U save

\$2. Min. order FOB N.Y.C. Add Postage all orders and 25% deposit. Worth 2-7230. Send for catalog 99. Specialists in International Export School, College & Industrial trade. Money-back "TAB" Guarantee.

"TAB" Dept. 10RC, 6 Church Street, New York 6, N.Y., U.S.A. "TAB" That's a Buy CORNER CHURCH & LIBERTY STS., ROOM 200 That's a Buy

FREE! SEND FOR IT

ALLIED'S 164-Page RADIO CATALOG

Save on Everything in Radio!



Here is everything in radio—in one **BIG**, easy-to-use book—at prices that save you money! New radios, phonos, complete PA equipment, test instruments, Ham equipment, thousands of parts, tubes, tools, books, diagrams, kits—everything for the experimenter, builder, serviceman, amateur. Send today for this **COMPLETE** Buying Guide. Get everything you need—save at **ALLIED**, Radio's expert, dependable supply source.

RADIO BUILDERS!



Low-Cost 5 Tube Kit
Complete with Cabinet, Loop Antenna & Tubes
The first ultra-modern 5 Tube AC-DC Superhet kit at so low a price!

Here's what you get—full broadcast coverage (550-1600 Kc); built-in loop antenna; latest 5" PM dynamic speaker; handsome walnut plastic cabinet. Easy to build; no special tools required. Sockets are riveted in place; just assemble, wire and slip into cabinet. Outstanding power and tone quality. Highest grade components. Complete with all parts, tubes and full instructions. Nothing like it at the price! Shipping weight, 10 lbs. **No. 83-275. Complete. ONLY \$1.95**



More than 10,000 items—Complete lines of all leading makes. Largest stocks of hard-to-get parts. Lowest money-saving prices. Get everything you need in Radio from **ALLIED!**



Public Address—entirely new line—new styling, new design features. Packaged Ready-to-Use Sound Systems; everything in amplifiers, speakers, mikes, intercom and recording.



Amateur Gear—immediate delivery on latest communications receivers. Time payment plan; trade-ins accepted. Headquarters for all ham and experimenters' needs.



Handy Radio Books
Radio Formulas and Data Dictionary of Radio Terms
Radio Circuit Handbook
Radio Builder's Handbook
Simplified Radio Servicing
Radio Data Handbook
ALL SIX BOOKS No. 37-799... \$1.00
Parallel Resistance and Series Capacitance Calculator. No. 37-960... 25c
R-F Resonance and Coil Winding Calculator. No. 37-965... 25c

ALLIED RADIO

ALLIED RADIO CORP.
833 W. Jackson Blvd., Dept 2-K-7, Chicago 7, Ill.

- Send FREE 164-Page Catalog
 - Send Kit No. 83-275
 - Send 6 Books No. 37-799
 - Send Calculator No.
- } enclosed

Name

Address

City.....Zone.....State.....

Communications

PROGRESS OF TELEVISION IN ENGLAND

As a television engineer, I find your magazine interesting and useful. It gives me the American angle on electronics in general. Your treatment of television seems a little odd. It is regarded as quite commonplace here after 10 years of successful daily broadcasting (excluding that little interval of hate!) Your articles and advertisements hailing it as one of the coming wonders of the age seem a trifle out of date.

To give you an idea of the size of our television industry, there had been granted as of February of this year 50,000 television receiving licenses. Assuming a few unlicensed receivers, the number must be a little above that.

(Major Hallows, the BBC and the British assistant Postmaster-General give figures between 15,000 and 25,000. —Editor)

The price of receivers is well below that of American models. The cheapest is a tuned radio-frequency set, giving television sound but no broadcast radio. It uses a 7-inch tube and costs \$140 plus purchase tax. A superheterodyne model with a 10-inch tube retails at \$200, and a console model with a 15-inch tube costs \$320.

As a serviceman, may I give a note of comfort to those of my profession on your side of the pond? I expect many of you are viewing the advent of television with something akin to apprehension, wondering about the expensive test gear you will have to buy. Forget it, brothers! The man who makes and sells

test gear will do his best to convince you that masses of elaborate apparatus are absolutely necessary. I do all my work with a multirange volt-ampere-ohmmeter and a "megger." Very rarely indeed do I use a 'scope.

The vision receiver and the sound receiver are just plain receivers and normal service methods apply. The 2 time bases, line and focus, can give rise to only a few faults, all of which proclaim their nature on the screen: nonlinearity, low amplitude, no scan, etc.

Voltage, current, and resistance checks will locate most faults rapidly, and the effect of any change is seen immediately on the screen. Another point—don't let the high voltage frighten you. The current present is so small that the shock is considerably less violent than from the plugs of an automobile.

JOHN W. TURNER
London, England

(Possibly the great difference in television in the two countries is a difference in the state of opinion. In the U. S. there are at present about 75,000 sets in operation, 9 stations broadcasting regular programs. About 10,000 sets a month are manufactured. Television will not have actually arrived till it is common in every town and city in the country. That day is not far off, as evidenced by the fact one of the larger manufacturers is beginning to produce at the rate of 250,000 sets per year. —Editor)

THREE VOTES ON RADIO-ELECTRONIC CIRCUITS

Dear Editor:

I am dismayed and disheartened by your latest **RADIO-ELECTRONIC CIRCUITS**. Instead of the broad, idea-filled items which I have used from time to time as the basis for useful construction, there appeared a group of articles which, as far as I could see, are of no help to me other than to show me how to improve (?) some circuits.

I might welcome such material if it were printed separately as articles. But as replacements for such a perfectly good series as the **ELECTRONIC CIRCUITS** has come to be, the newer stuff lacks quality. I hope the previous department will be resumed.

(Perhaps you can place these newer items in the **RADIO-ELECTRONICS MONTHLY REVIEW** department?)

ISIDOR UGELOW
Bronx, N. Y.

Dear Editor:

I find the new articles under the heading **RADIO-ELECTRONIC CIRCUITS** very interesting. These articles give a very good explanation of the various circuits'

operation, as well as how they can be adapted for use. I believe a person can obtain excellent instruction from articles of this nature and that reading them is time well spent.

I hope the change is approved by the readers and adopted as a permanent feature of the magazine.

SAMUEL TASHBY
Portland, Oregon



"It's for you!"

PHONO AMPLIFIER



3 Tube A.C.-D.C. Volume and Tone Controls; approx. 2.5 W. output; uses 12SK7, 50L6, 35Z5. Kit form \$2.35. Completely wired and tested 2.85. Kit of three tubes for above 12SK7, 50L6, 35Z5. 1.95. 5" Alnico P.M. Speaker. 1.45. Shure Glider or Astatic Crystal Pickup. 1.95. Alliance Flumo Motor. 3.25. Y.M. Mixer-Changer. 17.95. Maguire Automatic Record Changer. 13.95. All Prices F.O.B. Our Warehouse N. Y. 25% deposit Balance C.O.D.

RAYTONE ELECTRONIC COMPANY
25C Frankfort St., N. Y. 7, N. Y.

RANGEMASTER



MODEL 10
BY **BRADSHAW**
A COMPLETE SERVICE INSTRUMENT

The model 10 RANGE MASTER covers 25 ranges. Three direct reading capacity ranges. Three A.C. current ranges for checking current drain of electric motors and appliances.

All in One Rugged, Compact, Attractive Unit
COVERS THESE RANGES

A.C. VOLTAGE: 1-10-100-500-1000 Volts
D.C. VOLTAGE: 10-100-500-1000 Volts
A.C. CURRENT: .05-15-5-1.5-5-15 Amperes
D.C. CURRENT: 1-10-100-1,000 Milliamperes
RESISTANCE: RX10 RX100 RX1,000 Ohms
CAPACITANCE: .001-.1 .01-1 .1-10 Mfd.
Available in Kit Form \$16.95
Factory Assembled \$23.50
Test Leads .85

Available at your local dealer. If not write to us.
SEND FOR DESCRIPTIVE LITERATURE
BRADSHAW INSTRUMENTS CO.
942 Kings Highway, Brooklyn 23, New York

THE SIMPLEST FM CONVERTER



Don't throw away your 40-50 mc. FM tuner! Convert to 88-108 mc. operation with our Model 1002A FM converter. Connects in series with the antenna lead-in at the receiver. No power required. Works with all superheterodyne FM tuners or receivers. List price \$10.00.

Write for Information or see Your Local Parts Jobber

Crystal Devices Co.
P. O. Box 380 G. P. O.
New York 1, N. Y.

\$3.00 FOR CARTOON IDEAS

RADIO-CRAFT prints several radio cartoons every month. Readers are invited to contribute humorous radio ideas which can be used in cartoon form. It is not necessary that you draw a sketch, unless you wish.

IDEAS NOT WANTED

No electrical or radio definitions wanted. Some of these were published in the past, but the subject is about exhausted.

All checks are payable on publication.

Address **RADIO CARTOONS, RADIO-CRAFT, 25**
West Broadway, New York 7, N. Y.

Dear Editor:

May I suggest you alternate the procedure used in the RADIO-ELECTRONIC CIRCUITS department in the August issue of RADIO-CRAFT with that formerly used? The contents of the August issue were excellent and highly informative.
DUANE E. MROHS
Flint, Michigan

DX ON A 2-METER BEAM

Dear Editor:

You may be interested in some reports of work from the tower pictured and described in the August issue. I have been on the air on 2 meters, with the 32-element beam, last year's super-regenerative receiver, and a 2-meter transmitter with the 815 in the final running about 40 watts.

Results were beyond expectation. During one evening I worked 10 Massachusetts, 7 Connecticut and 6 Rhode Island stations in 4 hours, the beam pointing northeast. Pointing it south (at 11 pm) I immediately began to work New Jersey and Pennsylvania stations. Then came the great thrill of the evening. W3KUX, Washington, D. C.!

During the entire evening of 7 hours I did not hear a single report of QRM on the transmissions from W2BAV. This would seem ample proof of the power gain of the 32-element beam, if further proof were needed after that evening's work. All reception was on the little rush box.

Later I got a card from W4JHC, J. Ira Carlton, Buckroe Beach, Va. "Heard you on 2 meters calling CQ DX South." So we are getting down to the 4th district!

BILL HOISINGTON, W2BAV
Rye, N. Y.

CORRECTION

In the circuit of the Traveller's 2-Tuber, page 37 of the August, 1947, issue, the filament connections of the 3A8 should be reversed so that the No. 2 pin is grounded. This permits the pentode section of the tube to operate without bias while the triode section is biased by the voltage drop across half of the filament. The filament of this tube is center-tapped for series or parallel operation. The center tap and suppressor grid are connected to an internal shield and pin No. 1. This is left floating in this circuit.

We thank Mr. R. F. Klatt of Cleveland Heights, Ohio, for calling this to our attention.

SOLDERING KINK

Sometimes, when building compact radios or other equipment, it is hard to find sufficient space to solder ground leads from condensers or resistors to the chassis. I drill a small hole in the chassis and pass the lead through it and solder from the other side. This avoids working among cramped components, permits easy placement of parts, and facilitates unsoldering when necessary.

BERNARD GORDON,
Chicago, Ill.

LEEDS The house you have known for 25 years



BC-438 FREQUENCY METER

110 V. AC operated Range 195 to 215 megacycles; complete with tubes, crystal, calibration curves and schematic; only \$9⁹⁵

Laboratory Potentiometer

Wire wound, 100,000 ohm; made to G.R. Co. specifications; 25 watt, 6" diameter. Brand New. \$1.95



RELAYS—G.E. high current, 24v coil; contacts 200 amps. 39c
Sigma sensitive plug-in type, 5 draws, 2000 ohm; coil set at 4 Ma DC; hermetically sealed 95c

METERS

0-1 MA. G.E.—3" bakelite \$3.50
0-1 amp. RF G.E. 2" bakelite 2.45
50 millivolts basic movement, 3" bakelite, will give any range required by use of shunts or resistors 1.95

HEINEMANN CIRCUIT BREAKERS

Magnetic type, in 5-35-65 amp sizes. 95c

DICTOGRAPH carbon hand MIKE, chrome plated; with push to talk switch; while they last \$1.45

RADIO TRANSMITTER & RECEIVER APS 13

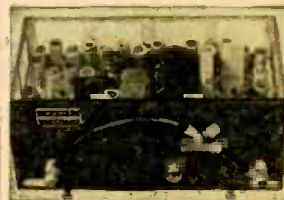

410-420 mc. light weight, fully enclosed; 30 mc. I.F. Complete with 17 tubes, including 5-6J6; 9/6AG5; 2/2221-1/VTR105; SCHEMATIC supplied with each unit. Only \$11.95

OIL FILLED CONDENSERS

1 Mfd 5000 V DC \$2.95 7 Mfd 330 V AC \$1.25
4 Mfd 500 V DC .35 0.02 Mfd 8000 V DC .98
10 Mfd 600 V DC .98 3 Mfd 2000 V DC. 1.75
16 Mfd 400 V DC .98

1N21B crystal DIODES, 3 for \$1.00
Telescoping antenna 30" 25c
Ouncer Mike to grid 25:1, low to high impedance 35c. 10 for \$2.95
Telegraph key J-37; 1/4" silver contacts 49c

PILOT LIGHT assembly WITH DIMMER, bayonet base type; red or white 19c
G.E. 0.1 Mfd 7500 V DC oil condenser \$1.75
TOBE 3 x 0.2 Mfd; 4000 V DC. 98c

SUPREME—Model 537 \$9.95 VOLT-OHMMETER

BRAND NEW—EXPORT PACKED 3" Full Vision Type Scale, with Basle 100 Microampere D'Arsonval Type Movement

A completely self-contained pocket type multimeter, with functions for the measurement of DC voltage from 0.1 to 600 volts in 4 ranges. Measurement of resistance from 1 ohm to 1,000,000 ohms (1 meg-ohm) can be made in 4 ranges. Height 5 3/4", width 3 3/4", depth 2 7/16". Shipping weight 3 lbs. Complete with operating instructions and circuit diagram.

BEST BUY OF THE MONTH

24 conductor rubber covered cable, 25 ft. 75c lengths; with H.B. Jones connector on each end

If not rated 25% with order, balance C.O.D. All prices F.O.B. our warehouse New York. No order under \$2. We ship to any part of the globe.

LEEDS RADIO CO.

75 VESEY ST., Dept. RCO
Cortland 7-2612 New York City, 7

BOOK REVIEWS

THE ELECTRON MICROSCOPE, by E. F. Burton and W. H. Kohl. Published by Reinhold Publishing Corporation. Stiff cloth covers, 6 x 9 1/4 inches, 325 pages. Price \$4.00.

The authors of this book were members of the Toronto group who pioneered the electron microscope; hence they know their subject from the embryo. Unlike other works on the subject, this is addressed mainly to the non-technical reader, who is warned, however, that "more than a superficial interest and a great deal of patience" will be required to understand the subject.

Starting with light optics, the action of a microscope is very clearly explained. Light itself is then studied and electron optics compared with light optics. Focussing of electron beams leads naturally to the electron microscope.

The simple presentation and complete illustrations enhance rather than detract from the scientific accuracy and thoroughness of the work, which is adapted to the needs of any person of whatever technical standing who is unfamiliar with the action of the electron microscope and wants to know more about it.

KLYSTRON TUBES, by A. E. Harrison. Published by the McGraw-Hill Book Co. Stiff cloth covers, 6 x 9 inches, 271 pages. Price \$3.50.

Written to supply more complete information on the operation of Klystrons than was made available in the older *Klystron Technical Manual*, this book has maintained the simple and clear style of the older work, while introducing a great deal of mathematical material. The book is so written however that the text can be followed by a reader who may not understand the mathematics involved.

Beginning with construction and operational theory, the book deals with reflex oscillators, multiple-resonator tubes, cascade amplifiers, frequency multipliers, frequency, phase, pulse and amplitude modulation and a number of other subjects.

Most useful to the engineer interested in high-frequency tubes, the book may also be read with profit by the general radioman who wishes to know how and why Klystrons operate.

THE ATOMIC STORY, by John W. Campbell. Published by Henry Holt & Co. Stiff cloth covers, 5 1/4 by 8 1/2 inches, 280 pages. Illustrated. Price \$3.00.

Mr. Campbell presents the atomic story in an easily read form, beginning with first approaches to the electron. The action of electrons in vacuum tubes is simply explained. Then come early discoveries in atomic action, leading up to the discovery of the nucleus. Operation of the mass spectrograph and electroscope is explained clearly and illustrations are given where necessary.

The construction of the atom is explained and illustrated so that the average reader can understand it. Then the author goes into the splitting of the atom and the action of the cyclotron.

Uranium chain reaction leading up to the making of the atomic bomb is then discussed. Next, the reader learns about the construction and action of the uranium pile. The production of plutonium, the separation of U-235, and the essential parts of an atomic bomb follow.

Closing chapters deal with the various effects of atomic bombs, atomic strategy and tactics, atomic energy and its promise for the future.—H.W.S.



LEARN EITHER ELECTRICITY OR RADIO

In a Few Weeks...in the GREAT SHOPS OF COYNE
Not a "Home-Study" Course

You'll learn fast at COYNE, using actual full-size equipment. Real shop work plus necessary theory. 48 years' success. 2 great Opportunity fields—rush coupon for FREE BOOK on course you prefer. For Veterans and non-veterans.

ELECTRICITY RADIO

Includes Motors, Armature Winding, Industrial and House Wiring, Power Plant Work, Maintenance, both AC or DC. Also new field of Industrial Electronics. Learn to build, shoot trouble on Radios, Public Address Systems, Sound Pictures, FM, Television. Training in Electric Refrigeration included. Send coupon.

FREE BOOK Get big, illustrated book on either course—no obligation. Tells how Coyne helps you.

B. W. COOKE, Pres. COYNE ELECTRICAL SCHOOL, Dept. 77-78H, 500 S. Paulina St., Chicago 12, Ill.

Send FREE BOOK and full details on course checked:
 ELECTRICITY RADIO

NAME.....
ADDRESS.....
CITY..... STATE.....

NOW—A REALLY HIGH-POWERED—Radio Engineering Library



NOTE: The Library comprises a selection of books culled from leading McGraw-Hill publications in the radio field.

- especially selected by radio specialists of McGraw-Hill publications
- to give most complete, dependable coverage of facts needed by all whose fields are grounded on radio fundamentals
- available at a special price and terms

THESE books cover circuit phenomena, tube theory, networks, measurements, and other subjects—give specialized treatments of all fields of practical design and application. They are books of recognized position in the literature—books you will refer to and be referred to often. If you are a practical designer, researcher or engineer in any field based on radio, you want these books for the help they give in hundreds of problems throughout the whole field of radio engineering.

5 VOLUMES, 3319 PAGES, 2289 ILLUSTRATIONS

1. Eastman's FUNDAMENTALS OF VACUUM TUBES
2. Terman's RADIO ENGINEERING
3. Everitt's COMMUNICATION ENGINEERING
4. Mund's HIGH FREQUENCY MEASUREMENTS
5. Henney's RADIO ENGINEERING HANDBOOK

10 days' examination. Easy terms. Special price under this offer less than books bought separately. Add these standard works to your library now; pay small monthly installments, while you use the books.

10 DAYS' FREE EXAMINATION—SEND COUPON

McGraw-Hill Book Co., 330 W. 42nd St., New York 18

Send me Radio Engineering Library, 5 vols., for 10 days' examination on approval. In 10 days I will send \$2.50, plus few cents postage, and \$4.00 monthly till \$25.00 is paid, or return books postpaid. (We pay postage on orders accompanied by remittance of the first installment.)

Name.....
Address.....
City and State.....
Company.....
Position..... RC-10-47

RADIO SCHOOL DIRECTORY

PREPARE NOW FOR SKILLED JOBS IN RADIO AND ELECTRONICS

CAREERS in RADIO

INTENSIVE COURSES—Thorough, technical education for progressive men and women.

Licensed by the State of New York

1. **RADIO TECHNICIAN**—The MRI General Course. Includes F.M. & Television. Prepares for FCC Broadcast Licenses.
2. **RADIO & TELEVISION SERVICING**—Prepares for employment as Repairman on Standard Broadcast, F.M. & Television Receivers.
3. **RADIO COMMUNICATIONS**—Prepares for FCC Operators' License. Leads to position as Merchant Marine or Flight Radio Officer; Commercial Operator.
4. **FUNDAMENTAL RADIO MATHEMATICS**—The MRI Preparatory Course. Required pre-training for students lacking a basic mathematical background.

MELVILLE RADIO INSTITUTE

MELVILLE BUILDING
15 WEST 46TH ST., N. Y. 19. BR 9-5080
"The Radio School Managed By Radio Men"

MELVILLE RADIO INSTITUTE

MELVILLE BUILDING
15 West 46th St., N. Y. 19, N. Y.

GENTLEMEN: RC
Send me FREE information about your school.

Name.....

Address.....

MAIL THIS COUPON NOW

LEARN NOW!

ELECTRONICS

- RADIO
- F.M. and TELEVISION
- PUBLIC ADDRESS SYSTEMS
- SHORT WAVE COMMUNICATIONS

Men! Women! Find successful careers in this fascinating field! Ample equipment for all to use in practical classes. You start practice when you enroll!

Approved for Veterans

HOLLYWOOD SOUND INSTITUTE

1040 N. Kenmore Ave., Dept. B
LOS ANGELES 27, CAL.

TELEVISION

Practical and Theoretical Technicians Course leads to opportunities in Industry, Broadcasting or own Business.

Day and Eve. Sessions.
Qualified Veterans Eligible.
ENROLL NOW FOR NEW CLASSES
RADIO-TELEVISION INSTITUTE

Pioneers in Television Training Since 1938
480 Lexington Ave., N. Y. 17 (46th St.)
Plaza 3-6385 Licensed by N. Y. State

Radio Technician and Announcers

A practical 15-month course in First Class Radiotelephone Operation and Announcing is offered by Don Martin School of Radio Arts. Most stations these days require combination men. We specialize in this type of training and maintain a placement bureau for our graduates. Serving the industry for 10 years, the School of Radio Arts can train you. Write for our catalogue outlining the courses offered. Classes can be arranged so you can do part time work on the side.

APPROVED FOR VETERANS

DON MARTIN SCHOOL OF RADIO ARTS
1655 North Cherokee St. Hollywood 28, Calif.

A CAREER WITH A FUTURE! TELEVISION

Shop Work • Shop Techniques • Theory
FULLY EQUIPPED LABORATORIES

- RADIO SERVICE & REPAIR
- F. M. & TELEVISION
- TRANSMITTER COURSES
- RADIO TECHNOLOGY

Preparing for F.C.C. LICENSES
A Junior College Level Course preparing for positions in Radio-Electronic Engineering Field.

MORNING • AFTERNOON • EVENING CLASSES
MODERATE RATES • INSTALLMENTS

Available Under G. I. Bill
COME IN AND SEE OUR STUDENTS AT WORK

DELEHANTY SCHOOL OF RADIO • ELECTRONICS • TELEVISION

105 EAST 13 ST., N. Y. 3, N. Y. • DEPT. R
LICENSED BY STATE OF NEW YORK

MEN ARE NEEDED FOR RADIO TELEVISION ELECTRONICS ENGINEERING

Thorough training in radio, including fundamentals, math, repair, sales, broadcasting, communications, with modern laboratory facilities and experienced faculty.

APPROVED FOR VETERANS TRAINING
Moderate tuition and living costs
New Classes Start Each Month
Dept. 4 Albuquerque, New Mexico

EGGERT RADIO INSTITUTE

RADIO COURSES

- RADIO OPERATING
- RADIO SERVICING — ELECTRONICS
- REFRIGERATION SERVICING

Personal Counselling Services for Veterans
Write for Latest Trade & Technical Catalog

Y.M.C.A. TRADE & TECHNICAL SCHOOLS
4 W. 64th Street New York City

CODE SENDING RECEIVING SPEED

Be a "key" man. Learn how to send and receive messages in code by telegraph and radio. Commerce needs thousands of men for jobs. Good pay, adventure, interesting work. Learn at home quickly through famous Candler System. Write for FREE BOOK.
CANDLER SYSTEM CO.
Dept. 3-L, Box 928, Denver 1, Colo., U. S. A.

PRACTICAL TECHNICAL TRAINING FOR YOU

Specialize in Electronics, Radio, Electricity, Refrigeration, Heating and Air Conditioning, or Welding. Prepare in one year for position as Technician, or in two additional years secure your B. S. Degree in ELECTRICAL ENGINEERING with major in Machinery or Electronics.

Write for booklet "Career Building"

MILWAUKEE SCHOOL OF ENGINEERING

INSTITUTE OF ELECTRONICS
RC-1047 N. Broadway and E. State, Milwaukee, Wis.

LEARN

RADIO

Get F.C.C. License

RADIO — TELEVISION

Repairing

Classes start every month

Our organization engaged in TECHNICAL TRAINING for 27 Years

LITERATURE ON REQUEST

BALTIMORE TECHNICAL INSTITUTE
1425 Eutaw Place. Balto. 17, Md.

APPROVED FOR VETERANS



RCA INSTITUTES, Inc.

Offer thorough training courses in all technical phases of Radio and Television
DAYS—EVENINGS WEEKLY RATES

VETERANS: RCA Institutes is approved under G. I. Bill of Rights
For Free Catalog Write Dept. RC-47

RCA INSTITUTES, Inc.
A Service of Radio Corporation of America
75 VARICK STREET NEW YORK 13, N. Y.

RADIO ENGINEERING!

Complete Radio Engineering Course. Bachelor of Science Degree. Courses also in Civil, Electrical, Mechanical, Chemical, Aeronautical Engineering; Business Administration, Accounting, Secretarial Science. Graduates successful. 64th year. Enter Sept., Jan., March, June. Write for catalog.

TRI-STATE COLLEGE 2489 College Ave. ANGOLA INDIANA

SOUND RECORDING SCHOOL

A practical 9 months' course in Sound Fundamentals, Recording, and Sound Transmission measurements; in a laboratory containing transmission sets, oscillators, square wave generator and intermodulation analyzer, and other equipment.

Two complete recording studios assimilating broadcast, motion picture and commercial sound recording, under the direction of H. M. Tremaine.

Approved for Veterans
DON MARTIN SCHOOL OF RADIO ARTS
1655 Cherokee St., Hollywood, Calif.

CORRESPONDENCE COURSES IN RADIO and ELECTRICAL ENGINEERING

ELECTRICAL ENGINEERING Get good grasp of electrical field. Prepare yourself at Low Cost, for secure future. Modern course. So simplified anyone can understand quickly.
RADIO ENGINEERING Extra fine course in radio, public address, photo-electric work. Trains you to be super-service man, real vacuum-tube technician. Servicemen needed badly. Diploma on completion. Many graduates earning big pay.
Send postcard for Free Copies of school catalog, full details, all about deferred payment plan, experimental kits, etc. \$25 Course
Lincoln Engineering School, Box 931C-104, Lincoln 2, Nebr.

COMMERCIAL RADIO INSTITUTE

A radio training center for 27 years.

RESIDENT COURSES ONLY

Broadcast, Service, Aeronautical, Television, F.M., Radar, and Marine telegraphy classes; Preparatory Course now forming. Literature upon request. Veteran training. Classes now forming for October 1st.
Dept. C, 38 West Biddle St., Baltimore 1, Md.

RADIO

TECHNICIAN and RADIO SERVICE COURSES
FM and TELEVISION

AMERICAN RADIO INSTITUTE
101 West 63rd St., New York 23, New York
Approved Under GI Bill of Rights
Licensed by New York State



PAPER

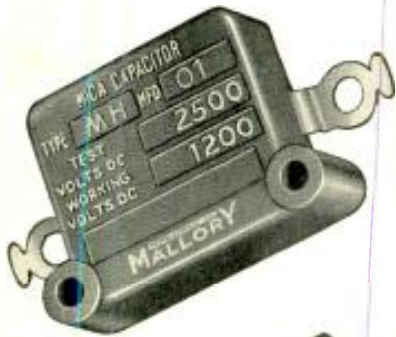

MICA



ELECTROLYTIC

CAPACITORS

MALLORY Precision Quality is Built in All Three

Service jobs that don't kick back are the ones that make a profit for you. When you use Mallory capacitors in your service work, you use capacitors *that don't kick back*. That's true whether the job calls for paper, mica or electrolytic capacitors.

Most servicemen know the big things behind Mallory capacitor quality. But there are many extra little things, too, that contribute to their life, uniformity and dependability.

Raw materials, for instance, that are held to an impurity level of less than one-half a part per million. Manufacturing techniques that prohibit human hands from even touching the capacitor cartridges. These are examples of the little things that make a world of difference in the final product. No wonder so many radio servicemen say:

You Expect More and Get More . . . from Mallory

P. R. MALLORY & CO. Inc.

MALLORY

VIBRATORS . . . VIBRAPACKS* . . . CAPACITORS . . . VOLUME CONTROLS . . . SWITCHES . . . RESISTORS . . . FILTERS . . . RECTIFIERS . . . POWER SUPPLIES.

*Reg. U. S. Pat. Off.

APPROVED PRECISION PRODUCTS

National Radio Week
Oct. 26—Nov. 1

P. R. MALLORY & CO., Inc., INDIANAPOLIS 6, INDIANA

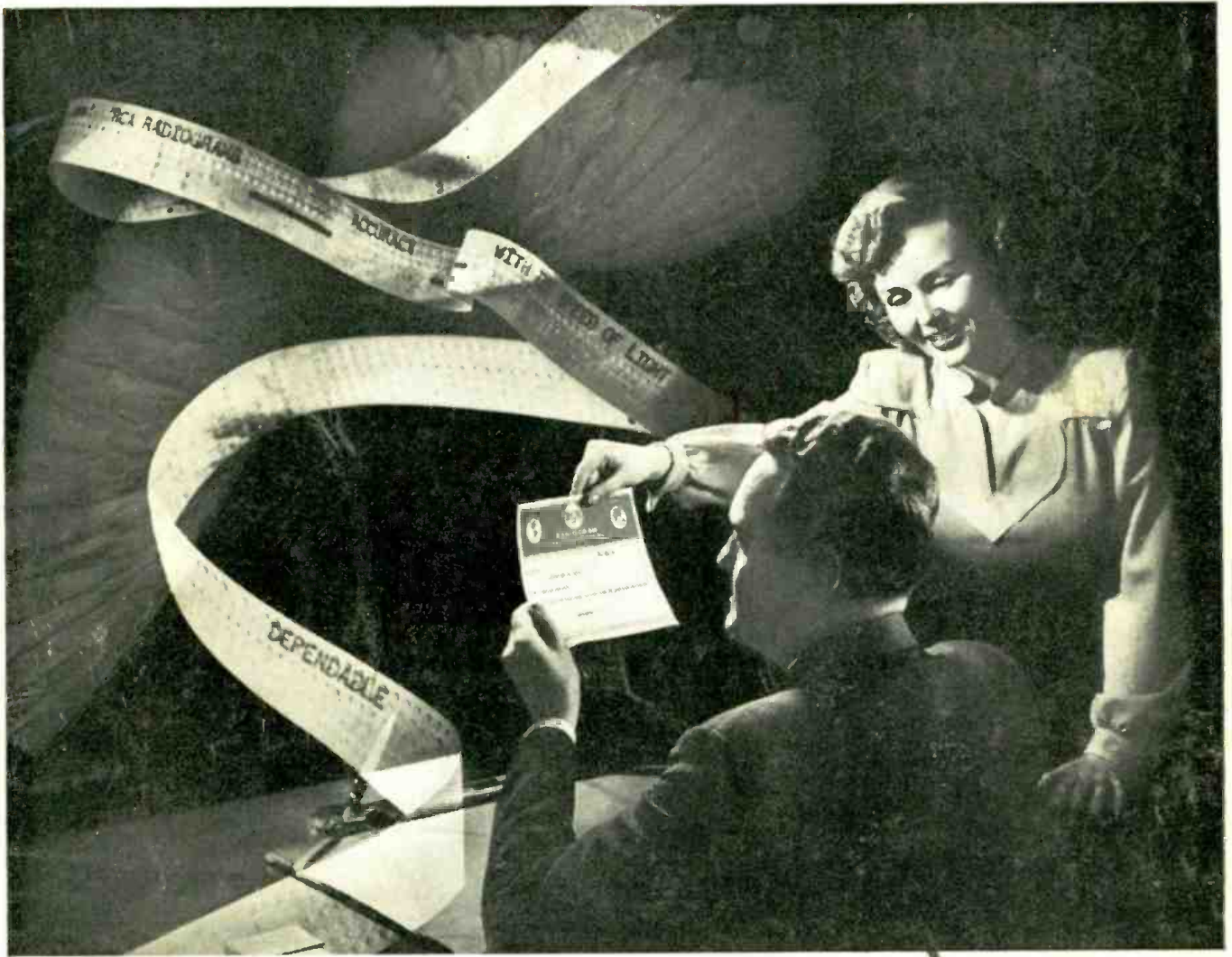

RCA Communications' new world-wide automatic tape relay radio system speeds Radiograms.

New wings for words around the world!

Radiograms "Via RCA" to and from overseas points now are processed by automatic machines which speed your messages through such gateway cities as New York, London, San Francisco and Manila, without delay.

This advanced technique in international radiotelegraphy is the result of wartime research and development. It gives to private messages the same speed, accuracy and dependability which were attained through its world-wide use by the U. S. Army Communications Service during the war.

RCA Laboratories—one of the world's foremost centers of radio and electronic research—is continually pioneering and advancing radio communications in service to the Nation and the public.

When you buy an RCA Victor radio or television receiver, Victrola radiophonograph, or phonograph record, you are getting, thanks to RCA research and engineering, one of the finest products of its kind science has achieved.

Radio Corporation of America, RCA Building, Radio City, New York 20. Listen to the RCA Victor Show, Sundays, 2:00 P.M., Eastern Daylight Saving Time, over the NBC Network.



At RCA Communications, "Package Sets" contain an automatic sending and receiving unit for a foreign gateway city. Messages, in tape form, received through these machines, are ready for quick delivery or immediate transmission to any part of the world.

"Victrola" T. M. Reg. U. S. Pat. Off.



RADIO CORPORATION of AMERICA

OCT 3 REC 100